







Codice assieme	Descrizione assieme	Immagine assieme
ASM3069A/0.D04	Impianto elettrico	
ASM3007A/0.D04	Porta	
ASM1745A/0.D03	Camera di cottura	
ASM1771A/0.D04	Copertura esterna	

ASM3069A/0.D04 - Impianto elettrico

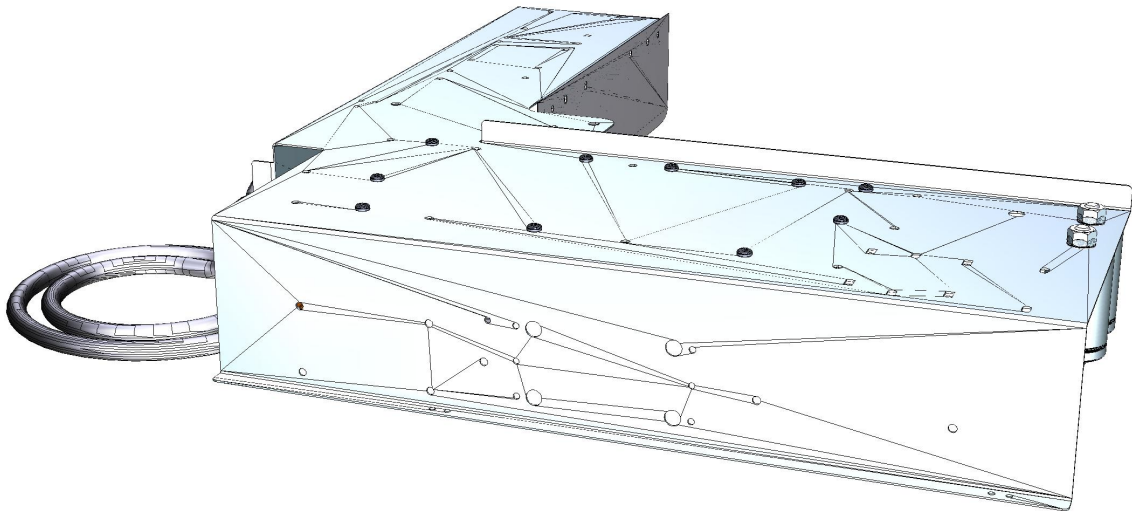

FRONTE





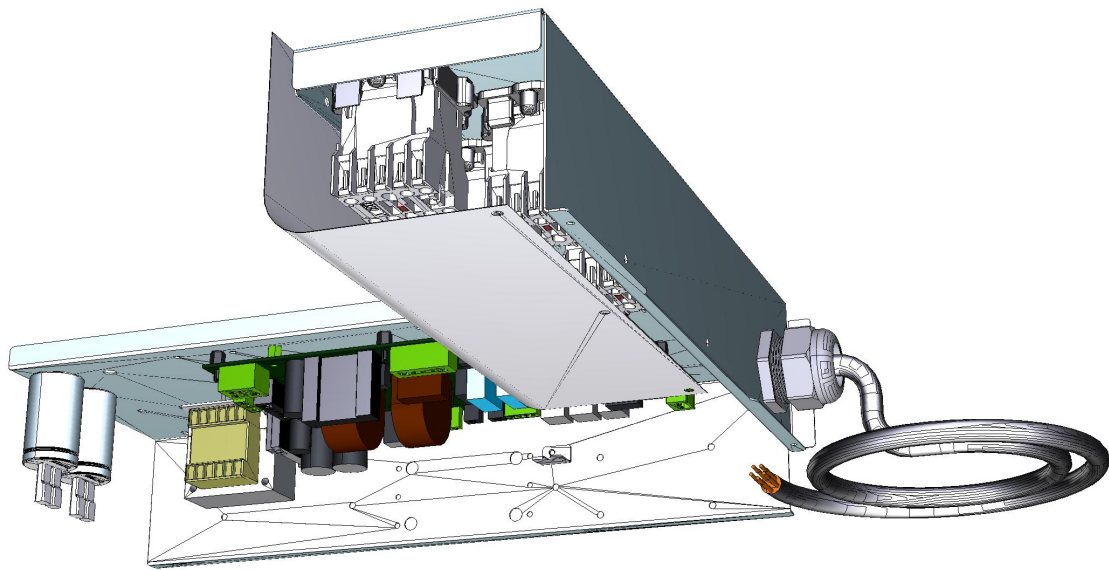

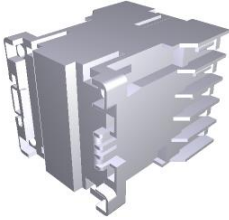

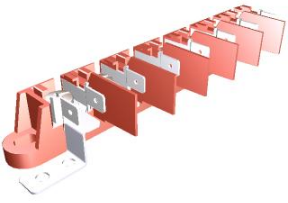
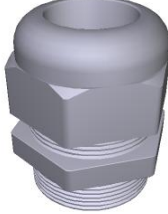
ASM3069A/0.D04 - Impianto elettrico

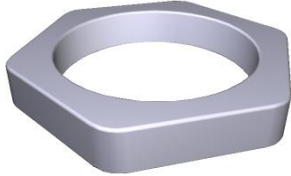
RETRO

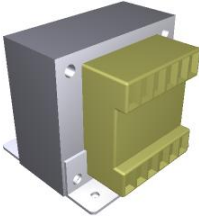

COMPONENTE			RICAMBIO																		
Codice	Descrizione	Immagine	Codice	Descrizione	Lista componenti																
CN1003A	CONDENSATORE CORAZZATO 6,3 UF		KCN1003A	KIT CONDENSATORE MOTORE 6,3 UF	<table border="1"> <thead> <tr> <th>Codice</th> <th>Descrizione</th> <th>Qtà</th> <th>UM</th> </tr> </thead> <tbody> <tr> <td>CN1003A0</td> <td>CONDENSATO RE CORAZZATO 6,3 UF</td> <td>1</td> <td>PZ</td> </tr> <tr> <td>VI1931A0</td> <td>DADO M8X1.65 H4 CH13 ZINCATO</td> <td>1</td> <td>PZ</td> </tr> <tr> <td>VI1932A0</td> <td>RONDELLA DENTELLATA D8 ZINCATA</td> <td>1</td> <td>PZ</td> </tr> </tbody> </table>	Codice	Descrizione	Qtà	UM	CN1003A0	CONDENSATO RE CORAZZATO 6,3 UF	1	PZ	VI1931A0	DADO M8X1.65 H4 CH13 ZINCATO	1	PZ	VI1932A0	RONDELLA DENTELLATA D8 ZINCATA	1	PZ
Codice	Descrizione	Qtà	UM																		
CN1003A0	CONDENSATO RE CORAZZATO 6,3 UF	1	PZ																		
VI1931A0	DADO M8X1.65 H4 CH13 ZINCATO	1	PZ																		
VI1932A0	RONDELLA DENTELLATA D8 ZINCATA	1	PZ																		
VE1115A	MINICONTATTORE QUADRIPOLORE 20 A 230V		KVE1115A	KIT MINICONTATTORE QUADRIPOLORE 20A 230V	<table border="1"> <thead> <tr> <th>Codice</th> <th>Descrizione</th> <th>Qtà</th> <th>UM</th> </tr> </thead> <tbody> <tr> <td>VE1115A0</td> <td>MINICONTATT ORE QUADRIPOLO RE 20 A 230V</td> <td>1</td> <td>PZ</td> </tr> <tr> <td>VM1075A1</td> <td>CLIP DI FISSAGGIO PER TELERUTTORI</td> <td>4</td> <td>PZ</td> </tr> </tbody> </table>	Codice	Descrizione	Qtà	UM	VE1115A0	MINICONTATT ORE QUADRIPOLO RE 20 A 230V	1	PZ	VM1075A1	CLIP DI FISSAGGIO PER TELERUTTORI	4	PZ				
Codice	Descrizione	Qtà	UM																		
VE1115A0	MINICONTATT ORE QUADRIPOLO RE 20 A 230V	1	PZ																		
VM1075A1	CLIP DI FISSAGGIO PER TELERUTTORI	4	PZ																		
VM1056A	STAFFA TELERUTTORE PICCOLO VE1115A		VM1056A0	STAFFA TELERUTTORE PICCOLO VE1115A																	
MR1004A	MORSETTIERA 7POLI 41A 450V		KMR1004A	KIT MORSETTIERA 7 POLI	<table border="1"> <thead> <tr> <th>Codice</th> <th>Descrizione</th> <th>Qtà</th> <th>UM</th> </tr> </thead> <tbody> <tr> <td>MR1004A1</td> <td>MORSETTIER A 7POLI 41A 450V</td> <td>1</td> <td>PZ</td> </tr> </tbody> </table>	Codice	Descrizione	Qtà	UM	MR1004A1	MORSETTIER A 7POLI 41A 450V	1	PZ								
Codice	Descrizione	Qtà	UM																		
MR1004A1	MORSETTIER A 7POLI 41A 450V	1	PZ																		
VE1645A	PRESSACAPO PG 29																				

COMPONENTE			RICAMBIO																						
Codice	Descrizione	Immagine	Codice	Descrizione	Lista componenti																				
VE1644A	DADO PRESSACAPO PG 29		VE1644A0	DADO PRESSACAPO PG 29																					
0H7374A	LAMIERINO TAGLIO CAVO SONDA CUOR		0H7374A0	LAMIERINO TAGLIO CAVO SONDA CUOR																					
CE1355A	CAVO 5X2,5MMQ H07RN-F L=1,5MT		KCE1355A	KIT CAVO 5X2.5 MMQ L1.5MT CE1355A1	<table border="1"> <thead> <tr> <th>Codice</th> <th>Descrizione</th> <th>Qtà</th> <th>UM</th> </tr> </thead> <tbody> <tr> <td>CE1355A1</td> <td>CAVO 5X2,5MMQ H07RN-F L=1,5MT</td> <td>1</td> <td>PZ</td> </tr> </tbody> </table>	Codice	Descrizione	Qtà	UM	CE1355A1	CAVO 5X2,5MMQ H07RN-F L=1,5MT	1	PZ												
Codice	Descrizione	Qtà	UM																						
CE1355A1	CAVO 5X2,5MMQ H07RN-F L=1,5MT	1	PZ																						
PE2037A	SCHEDA POTENZA MM ONE		KPE2037A	KIT SCHEDA POTENZA MIND.MAPS ONE	<table border="1"> <thead> <tr> <th>Codice</th> <th>Descrizione</th> <th>Qtà</th> <th>UM</th> </tr> </thead> <tbody> <tr> <td>PE2037A0</td> <td>SCHEDA POTENZA MM ONE</td> <td>1</td> <td>PZ</td> </tr> <tr> <td>VI1850A0</td> <td>VITE M4X6 TCB+ NICHELATA</td> <td>9</td> <td>PZ</td> </tr> <tr> <td>VM1745A0</td> <td>SUPPORTO PER SCHEDA</td> <td>9</td> <td>PZ</td> </tr> <tr> <td>VM2147A0</td> <td>SPUGNA ESD ROSA LISCIA 410X343X15 M</td> <td>1</td> <td>PZ</td> </tr> </tbody> </table>	Codice	Descrizione	Qtà	UM	PE2037A0	SCHEDA POTENZA MM ONE	1	PZ	VI1850A0	VITE M4X6 TCB+ NICHELATA	9	PZ	VM1745A0	SUPPORTO PER SCHEDA	9	PZ	VM2147A0	SPUGNA ESD ROSA LISCIA 410X343X15 M	1	PZ
Codice	Descrizione	Qtà	UM																						
PE2037A0	SCHEDA POTENZA MM ONE	1	PZ																						
VI1850A0	VITE M4X6 TCB+ NICHELATA	9	PZ																						
VM1745A0	SUPPORTO PER SCHEDA	9	PZ																						
VM2147A0	SPUGNA ESD ROSA LISCIA 410X343X15 M	1	PZ																						
VE1639A	TRASFORMATORE 230-12VAC 60VA		KVE1639A	KIT TRASFORMATORE 230-12VAC 60VA	<table border="1"> <thead> <tr> <th>Codice</th> <th>Descrizione</th> <th>Qtà</th> <th>UM</th> </tr> </thead> <tbody> <tr> <td>VE1639A0</td> <td>TRASFORMAT ORE 230-12VAC 60VA</td> <td>1</td> <td>PZ</td> </tr> <tr> <td>VI1950A0</td> <td>VITE AUTOFORANT E 4,2X13 TCB INOX</td> <td>4</td> <td>PZ</td> </tr> <tr> <td>VM2147A0</td> <td>SPUGNA ESD ROSA LISCIA 410X343X15 M</td> <td>1</td> <td>PZ</td> </tr> </tbody> </table>	Codice	Descrizione	Qtà	UM	VE1639A0	TRASFORMAT ORE 230-12VAC 60VA	1	PZ	VI1950A0	VITE AUTOFORANT E 4,2X13 TCB INOX	4	PZ	VM2147A0	SPUGNA ESD ROSA LISCIA 410X343X15 M	1	PZ				
Codice	Descrizione	Qtà	UM																						
VE1639A0	TRASFORMAT ORE 230-12VAC 60VA	1	PZ																						
VI1950A0	VITE AUTOFORANT E 4,2X13 TCB INOX	4	PZ																						
VM2147A0	SPUGNA ESD ROSA LISCIA 410X343X15 M	1	PZ																						

COMPONENTE			RICAMBIO		
<i>Codice</i>	<i>Descrizione</i>	<i>Immagine</i>	<i>Codice</i>	<i>Descrizione</i>	<i>Lista componenti</i>
VM2387A	PROTEZIONE TELERUTTORI MM XEVC		VM2387A0	PROTEZIONE TELERUTTORI MM XEVC	
0H7371A	PROFILO PORTA COMPONENTI MM XEBC		0H7371A0	PROFILO PORTA COMPONENTI MM XEBC	

ASM3007A/0.D04 - Porta

FRONTE

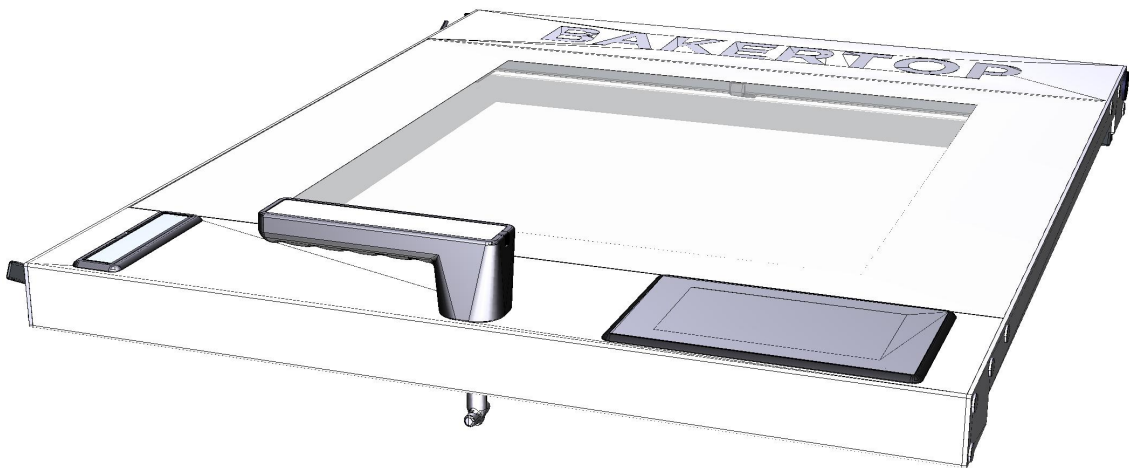

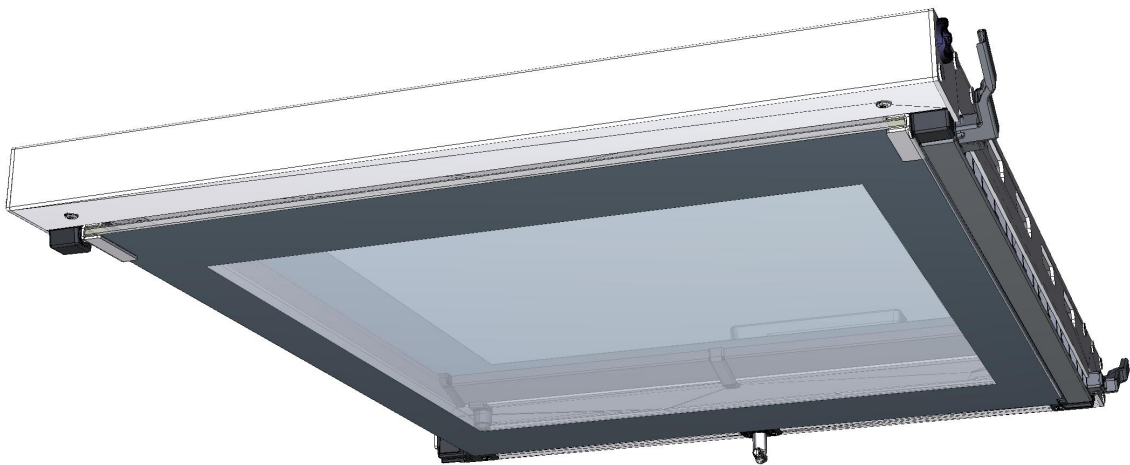

ASM3007A/0.D04 - Porta

RETRO





COMPONENTE			RICAMBIO																																																																		
<i>Codice</i>	<i>Descrizione</i>	<i>Immagine</i>	<i>Codice</i>	<i>Descrizione</i>	<i>Lista componenti</i>																																																																
MG1083A	ASSIEME MANIGLIA COMPLETO MM		KMG1083A	KIT MANIGLIA COMPLETA MM	<table border="1"> <thead> <tr> <th><i>Codice</i></th> <th><i>Descrizione</i></th> <th><i>Qtà</i></th> <th><i>UM</i></th> </tr> </thead> <tbody> <tr> <td>0H7321A0</td> <td>PIASTRINA COPERCHIETT O MANIGLIA M</td> <td>1</td> <td>PZ</td> </tr> <tr> <td>RC1200A0</td> <td>MOLLA A COMPRESSIO NE DE4 DF0.5 H24</td> <td>4</td> <td>PZ</td> </tr> <tr> <td>VI0239A1</td> <td>VITE AUTOFIL. 4.2X25 TCB+ INOX</td> <td>4</td> <td>PZ</td> </tr> <tr> <td>VI1220A1</td> <td>VITE AUTOFILETTA NTE 4.2X11 TCS+ MARUTE</td> <td>2</td> <td>PZ</td> </tr> <tr> <td>VM1182B0</td> <td>ATTACCO MANIGLIA CON GUIDA PERNO CT BT</td> <td>1</td> <td>PZ</td> </tr> <tr> <td>VM1182B1</td> <td>ATTACCO MANIGLIA CON GUIDA PERNO CT BT</td> <td>1</td> <td>PZ</td> </tr> <tr> <td>VM1183A1</td> <td>PERNO MANIGLIA CHEFTOP BAKERTOP</td> <td>1</td> <td>PZ</td> </tr> <tr> <td>VM1183B0</td> <td>PERNO MANIGLIA CT BT</td> <td>1</td> <td>PZ</td> </tr> <tr> <td>VM1490A0</td> <td>COPRI VITI MANIGLIA CHEFTOP BAKERTOP</td> <td>2</td> <td>PZ</td> </tr> <tr> <td>VM1695A0</td> <td>PERNO POSIZIONE MANIGLIA</td> <td>4</td> <td>PZ</td> </tr> <tr> <td>VM2245A0</td> <td>IMPUGNATUR A MANIGLIA CON SCROCC</td> <td>1</td> <td>PZ</td> </tr> <tr> <td>VM2247A0</td> <td>COVER IMPUGNATUR A MANIGLIA VM2245-2246</td> <td>1</td> <td>PZ</td> </tr> <tr> <td>VM2248A0</td> <td>CHIAVETTA CHIUSURA MANIGLIA CON SCROCC</td> <td>1</td> <td>PZ</td> </tr> <tr> <td>VM2248B0</td> <td>CHIAVETTA CHIUSURA MANIGLIA CON SCROCC</td> <td>1</td> <td>PZ</td> </tr> <tr> <td>VM2295A0</td> <td>PENNINO PER CONTROLLO MM</td> <td>1</td> <td>PZ</td> </tr> </tbody> </table>	<i>Codice</i>	<i>Descrizione</i>	<i>Qtà</i>	<i>UM</i>	0H7321A0	PIASTRINA COPERCHIETT O MANIGLIA M	1	PZ	RC1200A0	MOLLA A COMPRESSIO NE DE4 DF0.5 H24	4	PZ	VI0239A1	VITE AUTOFIL. 4.2X25 TCB+ INOX	4	PZ	VI1220A1	VITE AUTOFILETTA NTE 4.2X11 TCS+ MARUTE	2	PZ	VM1182B0	ATTACCO MANIGLIA CON GUIDA PERNO CT BT	1	PZ	VM1182B1	ATTACCO MANIGLIA CON GUIDA PERNO CT BT	1	PZ	VM1183A1	PERNO MANIGLIA CHEFTOP BAKERTOP	1	PZ	VM1183B0	PERNO MANIGLIA CT BT	1	PZ	VM1490A0	COPRI VITI MANIGLIA CHEFTOP BAKERTOP	2	PZ	VM1695A0	PERNO POSIZIONE MANIGLIA	4	PZ	VM2245A0	IMPUGNATUR A MANIGLIA CON SCROCC	1	PZ	VM2247A0	COVER IMPUGNATUR A MANIGLIA VM2245-2246	1	PZ	VM2248A0	CHIAVETTA CHIUSURA MANIGLIA CON SCROCC	1	PZ	VM2248B0	CHIAVETTA CHIUSURA MANIGLIA CON SCROCC	1	PZ	VM2295A0	PENNINO PER CONTROLLO MM	1	PZ
<i>Codice</i>	<i>Descrizione</i>	<i>Qtà</i>	<i>UM</i>																																																																		
0H7321A0	PIASTRINA COPERCHIETT O MANIGLIA M	1	PZ																																																																		
RC1200A0	MOLLA A COMPRESSIO NE DE4 DF0.5 H24	4	PZ																																																																		
VI0239A1	VITE AUTOFIL. 4.2X25 TCB+ INOX	4	PZ																																																																		
VI1220A1	VITE AUTOFILETTA NTE 4.2X11 TCS+ MARUTE	2	PZ																																																																		
VM1182B0	ATTACCO MANIGLIA CON GUIDA PERNO CT BT	1	PZ																																																																		
VM1182B1	ATTACCO MANIGLIA CON GUIDA PERNO CT BT	1	PZ																																																																		
VM1183A1	PERNO MANIGLIA CHEFTOP BAKERTOP	1	PZ																																																																		
VM1183B0	PERNO MANIGLIA CT BT	1	PZ																																																																		
VM1490A0	COPRI VITI MANIGLIA CHEFTOP BAKERTOP	2	PZ																																																																		
VM1695A0	PERNO POSIZIONE MANIGLIA	4	PZ																																																																		
VM2245A0	IMPUGNATUR A MANIGLIA CON SCROCC	1	PZ																																																																		
VM2247A0	COVER IMPUGNATUR A MANIGLIA VM2245-2246	1	PZ																																																																		
VM2248A0	CHIAVETTA CHIUSURA MANIGLIA CON SCROCC	1	PZ																																																																		
VM2248B0	CHIAVETTA CHIUSURA MANIGLIA CON SCROCC	1	PZ																																																																		
VM2295A0	PENNINO PER CONTROLLO MM	1	PZ																																																																		

COMPONENTE			RICAMBIO																																																																						
Codice	Descrizione	Immagine	Codice	Descrizione	Lista componenti																																																																				
VM2274A	BOCCOLA SCANALATA		KVM2274A	KIT BOCCOLA SCANALATA VM2274A0	<table border="1"> <thead> <tr> <th>Codice</th> <th>Descrizione</th> <th>Qtà</th> <th>UM</th> </tr> </thead> <tbody> <tr> <td>VM2274A0</td> <td>BOCCOLA SCANALATA</td> <td>1</td> <td>PZ</td> </tr> </tbody> </table>	Codice	Descrizione	Qtà	UM	VM2274A0	BOCCOLA SCANALATA	1	PZ																																																												
			Codice	Descrizione	Qtà	UM																																																																			
VM2274A0	BOCCOLA SCANALATA	1	PZ																																																																						
K0B1126AR	KIT TRAVERSO INF. PORTA BAKERTOP DX	<table border="1"> <thead> <tr> <th>Codice</th> <th>Descrizione</th> <th>Qtà</th> <th>UM</th> </tr> </thead> <tbody> <tr> <td>0B1126A0</td> <td>TRAVERSO INFERIORE PORTA 860 M</td> <td>1</td> <td>PZ</td> </tr> <tr> <td>RC1200A0</td> <td>MOLLA A COMPRESSIO NE DE4 DF0.5 H24</td> <td>2</td> <td>PZ</td> </tr> <tr> <td>VI1220A1</td> <td>VITE AUTOFILETTA NTE 4.2X11 TCS+ MARUTE</td> <td>1</td> <td>PZ</td> </tr> <tr> <td>VI1996A0</td> <td>VITE M5X35 TCEI ZN</td> <td>7</td> <td>PZ</td> </tr> <tr> <td>VM1794A0</td> <td>FASCETTA 250X4.8 PA66 NERA</td> <td>2</td> <td>PZ</td> </tr> <tr> <td>VM2103A0</td> <td>PIASTRINA FERMAFASCE TTA</td> <td>2</td> <td>PZ</td> </tr> <tr> <td>VM2259A1</td> <td>TAPPO INF SX PORTA S6</td> <td>1</td> <td>PZ</td> </tr> <tr> <td>VM2261A1</td> <td>TAPPO INF DX PORTA S6</td> <td>1</td> <td>PZ</td> </tr> <tr> <td>VM2267A0</td> <td>CORSOIO SISTEMA FERMA VETRO INT</td> <td>1</td> <td>PZ</td> </tr> <tr> <td>VM2269A0</td> <td>TAPPO SISTEMA FERMA VETRO INT</td> <td>1</td> <td>PZ</td> </tr> <tr> <td>VM2274A0</td> <td>BOCCOLA SCANALATA</td> <td>1</td> <td>PZ</td> </tr> <tr> <td>VM2305A0</td> <td>NOTTOLINO FISSAGGIO TAPPI PORTE MM</td> <td>7</td> <td>PZ</td> </tr> </tbody> </table>	Codice	Descrizione	Qtà	UM	0B1126A0	TRAVERSO INFERIORE PORTA 860 M	1	PZ	RC1200A0	MOLLA A COMPRESSIO NE DE4 DF0.5 H24	2	PZ	VI1220A1	VITE AUTOFILETTA NTE 4.2X11 TCS+ MARUTE	1	PZ	VI1996A0	VITE M5X35 TCEI ZN	7	PZ	VM1794A0	FASCETTA 250X4.8 PA66 NERA	2	PZ	VM2103A0	PIASTRINA FERMAFASCE TTA	2	PZ	VM2259A1	TAPPO INF SX PORTA S6	1	PZ	VM2261A1	TAPPO INF DX PORTA S6	1	PZ	VM2267A0	CORSOIO SISTEMA FERMA VETRO INT	1	PZ	VM2269A0	TAPPO SISTEMA FERMA VETRO INT	1	PZ	VM2274A0	BOCCOLA SCANALATA	1	PZ	VM2305A0	NOTTOLINO FISSAGGIO TAPPI PORTE MM	7	PZ	K0B1126AL	KIT TRAVERSO INF PORTA BAKERTOP SX	<table border="1"> <thead> <tr> <th>Codice</th> <th>Descrizione</th> <th>Qtà</th> <th>UM</th> </tr> </thead> <tbody> <tr> <td>0B1126A0</td> <td>TRAVERSO INFERIORE PORTA 860 M</td> <td>1</td> <td>PZ</td> </tr> <tr> <td>RC1200A0</td> <td>MOLLA A COMPRESSIO NE DE4 DF0.5 H24</td> <td>2</td> <td>PZ</td> </tr> <tr> <td>VI1220A1</td> <td>VITE AUTOFILETTA NTE 4.2X11 TCS+ MARUTE</td> <td>1</td> <td>PZ</td> </tr> </tbody> </table>	Codice	Descrizione	Qtà	UM	0B1126A0	TRAVERSO INFERIORE PORTA 860 M	1	PZ	RC1200A0	MOLLA A COMPRESSIO NE DE4 DF0.5 H24	2	PZ	VI1220A1	VITE AUTOFILETTA NTE 4.2X11 TCS+ MARUTE	1	PZ
Codice	Descrizione	Qtà	UM																																																																						
0B1126A0	TRAVERSO INFERIORE PORTA 860 M	1	PZ																																																																						
RC1200A0	MOLLA A COMPRESSIO NE DE4 DF0.5 H24	2	PZ																																																																						
VI1220A1	VITE AUTOFILETTA NTE 4.2X11 TCS+ MARUTE	1	PZ																																																																						
VI1996A0	VITE M5X35 TCEI ZN	7	PZ																																																																						
VM1794A0	FASCETTA 250X4.8 PA66 NERA	2	PZ																																																																						
VM2103A0	PIASTRINA FERMAFASCE TTA	2	PZ																																																																						
VM2259A1	TAPPO INF SX PORTA S6	1	PZ																																																																						
VM2261A1	TAPPO INF DX PORTA S6	1	PZ																																																																						
VM2267A0	CORSOIO SISTEMA FERMA VETRO INT	1	PZ																																																																						
VM2269A0	TAPPO SISTEMA FERMA VETRO INT	1	PZ																																																																						
VM2274A0	BOCCOLA SCANALATA	1	PZ																																																																						
VM2305A0	NOTTOLINO FISSAGGIO TAPPI PORTE MM	7	PZ																																																																						
Codice	Descrizione	Qtà	UM																																																																						
0B1126A0	TRAVERSO INFERIORE PORTA 860 M	1	PZ																																																																						
RC1200A0	MOLLA A COMPRESSIO NE DE4 DF0.5 H24	2	PZ																																																																						
VI1220A1	VITE AUTOFILETTA NTE 4.2X11 TCS+ MARUTE	1	PZ																																																																						

COMPONENTE			RICAMBIO																																										
Codice	Descrizione	Immagine	Codice	Descrizione	Lista componenti																																								
VM2274A	BOCCOLA SCANALATA		K0B1126AL	KIT TRAVERSO INF PORTA BAKERTOP SX	<table border="1"> <thead> <tr> <th>Codice</th> <th>Descrizione</th> <th>Qtà</th> <th>UM</th> </tr> </thead> <tbody> <tr> <td>VI1996A0</td> <td>VITE M5X35 TCEI ZN</td> <td>7</td> <td>PZ</td> </tr> <tr> <td>VM1794A0</td> <td>FASCETTA 250X4.8 PA66 NERA</td> <td>2</td> <td>PZ</td> </tr> <tr> <td>VM2103A0</td> <td>PIASTRINA FERMAFASCE TTA</td> <td>2</td> <td>PZ</td> </tr> <tr> <td>VM2267A0</td> <td>CORSOIO SISTEMA FERMA VETRO INT</td> <td>1</td> <td>PZ</td> </tr> <tr> <td>VM2269A0</td> <td>TAPPO SISTEMA FERMA VETRO INT</td> <td>1</td> <td>PZ</td> </tr> <tr> <td>VM2274A0</td> <td>BOCCOLA SCANALATA</td> <td>1</td> <td>PZ</td> </tr> <tr> <td>VM2305A0</td> <td>NOTTOLINO FISSAGGIO TAPPI PORTE MM</td> <td>7</td> <td>PZ</td> </tr> <tr> <td>VM2384A0</td> <td>TAPPO INF DX PORTA MM LEFT</td> <td>1</td> <td>PZ</td> </tr> <tr> <td>VM2386A1</td> <td>TAPPO INF SX PORTA MM LEFT</td> <td>1</td> <td>PZ</td> </tr> </tbody> </table>	Codice	Descrizione	Qtà	UM	VI1996A0	VITE M5X35 TCEI ZN	7	PZ	VM1794A0	FASCETTA 250X4.8 PA66 NERA	2	PZ	VM2103A0	PIASTRINA FERMAFASCE TTA	2	PZ	VM2267A0	CORSOIO SISTEMA FERMA VETRO INT	1	PZ	VM2269A0	TAPPO SISTEMA FERMA VETRO INT	1	PZ	VM2274A0	BOCCOLA SCANALATA	1	PZ	VM2305A0	NOTTOLINO FISSAGGIO TAPPI PORTE MM	7	PZ	VM2384A0	TAPPO INF DX PORTA MM LEFT	1	PZ	VM2386A1	TAPPO INF SX PORTA MM LEFT	1	PZ
			Codice		Descrizione	Qtà	UM																																						
VI1996A0	VITE M5X35 TCEI ZN	7	PZ																																										
VM1794A0	FASCETTA 250X4.8 PA66 NERA	2	PZ																																										
VM2103A0	PIASTRINA FERMAFASCE TTA	2	PZ																																										
VM2267A0	CORSOIO SISTEMA FERMA VETRO INT	1	PZ																																										
VM2269A0	TAPPO SISTEMA FERMA VETRO INT	1	PZ																																										
VM2274A0	BOCCOLA SCANALATA	1	PZ																																										
VM2305A0	NOTTOLINO FISSAGGIO TAPPI PORTE MM	7	PZ																																										
VM2384A0	TAPPO INF DX PORTA MM LEFT	1	PZ																																										
VM2386A1	TAPPO INF SX PORTA MM LEFT	1	PZ																																										
K0B1122AR	KIT TRAVERSO INF. PORTA CHEFTOP D	<table border="1"> <thead> <tr> <th>Codice</th> <th>Descrizione</th> <th>Qtà</th> <th>UM</th> </tr> </thead> <tbody> <tr> <td>0B1122A0</td> <td>TRAVERSO INFERIORE PORTA 750 M</td> <td>1</td> <td>PZ</td> </tr> <tr> <td>RC1200A0</td> <td>MOLLA A COMPRESSIO NE DE4 DF0.5 H24</td> <td>2</td> <td>PZ</td> </tr> <tr> <td>VI1220A1</td> <td>VITE AUTOFILETTA NTE 4.2X11 TCS+ MARUTE</td> <td>1</td> <td>PZ</td> </tr> <tr> <td>VI1996A0</td> <td>VITE M5X35 TCEI ZN</td> <td>7</td> <td>PZ</td> </tr> <tr> <td>VM1794A0</td> <td>FASCETTA 250X4.8 PA66 NERA</td> <td>2</td> <td>PZ</td> </tr> <tr> <td>VM2103A0</td> <td>PIASTRINA FERMAFASCE TTA</td> <td>2</td> <td>PZ</td> </tr> <tr> <td>VM2259A1</td> <td>TAPPO INF SX PORTA S6</td> <td>1</td> <td>PZ</td> </tr> <tr> <td>VM2261A1</td> <td>TAPPO INF DX PORTA S6</td> <td>1</td> <td>PZ</td> </tr> </tbody> </table>	Codice		Descrizione	Qtà	UM	0B1122A0	TRAVERSO INFERIORE PORTA 750 M	1	PZ	RC1200A0	MOLLA A COMPRESSIO NE DE4 DF0.5 H24	2	PZ	VI1220A1	VITE AUTOFILETTA NTE 4.2X11 TCS+ MARUTE	1	PZ	VI1996A0	VITE M5X35 TCEI ZN	7	PZ	VM1794A0	FASCETTA 250X4.8 PA66 NERA	2	PZ	VM2103A0	PIASTRINA FERMAFASCE TTA	2	PZ	VM2259A1	TAPPO INF SX PORTA S6	1	PZ	VM2261A1	TAPPO INF DX PORTA S6	1	PZ						
Codice		Descrizione	Qtà		UM																																								
0B1122A0		TRAVERSO INFERIORE PORTA 750 M	1		PZ																																								
RC1200A0		MOLLA A COMPRESSIO NE DE4 DF0.5 H24	2	PZ																																									
VI1220A1		VITE AUTOFILETTA NTE 4.2X11 TCS+ MARUTE	1	PZ																																									
VI1996A0		VITE M5X35 TCEI ZN	7	PZ																																									
VM1794A0		FASCETTA 250X4.8 PA66 NERA	2	PZ																																									
VM2103A0		PIASTRINA FERMAFASCE TTA	2	PZ																																									
VM2259A1		TAPPO INF SX PORTA S6	1	PZ																																									
VM2261A1		TAPPO INF DX PORTA S6	1	PZ																																									

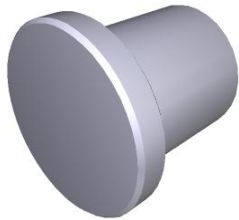
COMPONENTE			RICAMBIO																																																			
Codice	Descrizione	Immagine	Codice	Descrizione	Lista componenti																																																	
VM2274A	BOCCOLA SCANALATA		K0B1122AR	KIT TRAVERSO INF. PORTA CHEFTOP D	<table border="1"> <thead> <tr> <th>Codice</th> <th>Descrizione</th> <th>Qtà</th> <th>UM</th> </tr> </thead> <tbody> <tr> <td>VM2267A0</td> <td>CORSOIO SISTEMA FERMA VETRO INT</td> <td>1</td> <td>PZ</td> </tr> <tr> <td>VM2269A0</td> <td>TAPPO SISTEMA FERMA VETRO INT</td> <td>1</td> <td>PZ</td> </tr> <tr> <td>VM2274A0</td> <td>BOCCOLA SCANALATA</td> <td>1</td> <td>PZ</td> </tr> <tr> <td>VM2305A0</td> <td>NOTTOLINO FISSAGGIO TAPPI PORTE MM</td> <td>7</td> <td>PZ</td> </tr> </tbody> </table>	Codice	Descrizione	Qtà	UM	VM2267A0	CORSOIO SISTEMA FERMA VETRO INT	1	PZ	VM2269A0	TAPPO SISTEMA FERMA VETRO INT	1	PZ	VM2274A0	BOCCOLA SCANALATA	1	PZ	VM2305A0	NOTTOLINO FISSAGGIO TAPPI PORTE MM	7	PZ																													
			Codice	Descrizione	Qtà	UM																																																
VM2267A0	CORSOIO SISTEMA FERMA VETRO INT	1	PZ																																																			
VM2269A0	TAPPO SISTEMA FERMA VETRO INT	1	PZ																																																			
VM2274A0	BOCCOLA SCANALATA	1	PZ																																																			
VM2305A0	NOTTOLINO FISSAGGIO TAPPI PORTE MM	7	PZ																																																			
K0B1122AL	KIT TRAVERSO INF. PORTA CHEFTOP MM SX	<table border="1"> <thead> <tr> <th>Codice</th> <th>Descrizione</th> <th>Qtà</th> <th>UM</th> </tr> </thead> <tbody> <tr> <td>0B1122A0</td> <td>TRAVERSO INFERIORE PORTA 750 M</td> <td>1</td> <td>PZ</td> </tr> <tr> <td>RC1200A0</td> <td>MOLLA A COMPRESSIO NE DE4 DF0.5 H24</td> <td>2</td> <td>PZ</td> </tr> <tr> <td>VI1220A1</td> <td>VITE AUTOFILETTA NTE 4.2X11 TCS+ MARUTE</td> <td>1</td> <td>PZ</td> </tr> <tr> <td>VI1996A0</td> <td>VITE M5X35 TCEI ZN</td> <td>7</td> <td>PZ</td> </tr> <tr> <td>VM1794A0</td> <td>FASCETTA 250X4.8 PA66 NERA</td> <td>2</td> <td>PZ</td> </tr> <tr> <td>VM2103A0</td> <td>PIASTRINA FERMAFASCE TTA</td> <td>2</td> <td>PZ</td> </tr> <tr> <td>VM2267A0</td> <td>CORSOIO SISTEMA FERMA VETRO INT</td> <td>1</td> <td>PZ</td> </tr> <tr> <td>VM2269A0</td> <td>TAPPO SISTEMA FERMA VETRO INT</td> <td>1</td> <td>PZ</td> </tr> <tr> <td>VM2274A0</td> <td>BOCCOLA SCANALATA</td> <td>1</td> <td>PZ</td> </tr> <tr> <td>VM2305A0</td> <td>NOTTOLINO FISSAGGIO TAPPI PORTE MM</td> <td>7</td> <td>PZ</td> </tr> <tr> <td>VM2384A0</td> <td>TAPPO INF DX PORTA MM LEFT</td> <td>1</td> <td>PZ</td> </tr> <tr> <td>VM2386A1</td> <td>TAPPO INF SX PORTA MM LEFT</td> <td>1</td> <td>PZ</td> </tr> </tbody> </table>	Codice	Descrizione	Qtà	UM	0B1122A0	TRAVERSO INFERIORE PORTA 750 M	1	PZ	RC1200A0	MOLLA A COMPRESSIO NE DE4 DF0.5 H24	2	PZ	VI1220A1	VITE AUTOFILETTA NTE 4.2X11 TCS+ MARUTE	1	PZ	VI1996A0	VITE M5X35 TCEI ZN	7	PZ	VM1794A0	FASCETTA 250X4.8 PA66 NERA	2	PZ	VM2103A0	PIASTRINA FERMAFASCE TTA	2	PZ	VM2267A0	CORSOIO SISTEMA FERMA VETRO INT	1	PZ	VM2269A0	TAPPO SISTEMA FERMA VETRO INT	1	PZ	VM2274A0	BOCCOLA SCANALATA	1	PZ	VM2305A0	NOTTOLINO FISSAGGIO TAPPI PORTE MM	7	PZ	VM2384A0	TAPPO INF DX PORTA MM LEFT	1	PZ	VM2386A1	TAPPO INF SX PORTA MM LEFT	1	PZ
Codice	Descrizione	Qtà	UM																																																			
0B1122A0	TRAVERSO INFERIORE PORTA 750 M	1	PZ																																																			
RC1200A0	MOLLA A COMPRESSIO NE DE4 DF0.5 H24	2	PZ																																																			
VI1220A1	VITE AUTOFILETTA NTE 4.2X11 TCS+ MARUTE	1	PZ																																																			
VI1996A0	VITE M5X35 TCEI ZN	7	PZ																																																			
VM1794A0	FASCETTA 250X4.8 PA66 NERA	2	PZ																																																			
VM2103A0	PIASTRINA FERMAFASCE TTA	2	PZ																																																			
VM2267A0	CORSOIO SISTEMA FERMA VETRO INT	1	PZ																																																			
VM2269A0	TAPPO SISTEMA FERMA VETRO INT	1	PZ																																																			
VM2274A0	BOCCOLA SCANALATA	1	PZ																																																			
VM2305A0	NOTTOLINO FISSAGGIO TAPPI PORTE MM	7	PZ																																																			
VM2384A0	TAPPO INF DX PORTA MM LEFT	1	PZ																																																			
VM2386A1	TAPPO INF SX PORTA MM LEFT	1	PZ																																																			

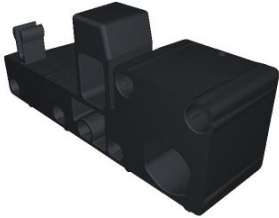
COMPONENTE			RICAMBIO																																						
Codice	Descrizione	Immagine	Codice	Descrizione	Lista componenti																																				
VM2305A	NOTTOLINO FISSAGGIO TAPPI PORTE MM		VM2305A0	NOTTOLINO FISSAGGIO TAPPI PORTE MM																																					
VI1996A	VITE M5X35 TCEI ZN		VI1996A0	VITE M5X35 TCEI ZN																																					
VM2259A	TAPPO INF SX PORTA S6		KVM2259A	KIT TAPPO INFERIORE SX PORTA MM	<table border="1"> <thead> <tr> <th>Codice</th> <th>Descrizione</th> <th>Qtà</th> <th>UM</th> </tr> </thead> <tbody> <tr> <td>VI1996A0</td> <td>VITE M5X35 TCEI ZN</td> <td>3</td> <td>PZ</td> </tr> <tr> <td>VM2259A1</td> <td>TAPPO INF SX PORTA S6</td> <td>1</td> <td>PZ</td> </tr> <tr> <td>VM2305A0</td> <td>NOTTOLINO FISSAGGIO TAPPI PORTE MM</td> <td>3</td> <td>PZ</td> </tr> </tbody> </table>	Codice	Descrizione	Qtà	UM	VI1996A0	VITE M5X35 TCEI ZN	3	PZ	VM2259A1	TAPPO INF SX PORTA S6	1	PZ	VM2305A0	NOTTOLINO FISSAGGIO TAPPI PORTE MM	3	PZ																				
Codice	Descrizione	Qtà	UM																																						
VI1996A0	VITE M5X35 TCEI ZN	3	PZ																																						
VM2259A1	TAPPO INF SX PORTA S6	1	PZ																																						
VM2305A0	NOTTOLINO FISSAGGIO TAPPI PORTE MM	3	PZ																																						
			K0B1126AR	KIT TRAVERSO INF. PORTA BAKERTOP DX	<table border="1"> <thead> <tr> <th>Codice</th> <th>Descrizione</th> <th>Qtà</th> <th>UM</th> </tr> </thead> <tbody> <tr> <td>0B1126A0</td> <td>TRAVERSO INFERIORE PORTA 860 M</td> <td>1</td> <td>PZ</td> </tr> <tr> <td>RC1200A0</td> <td>MOLLA A COMPRESSIO NE DE4 DF0.5 H24</td> <td>2</td> <td>PZ</td> </tr> <tr> <td>VI1220A1</td> <td>VITE AUTOFILETTA NTE 4.2X11 TCS+ MARUTE</td> <td>1</td> <td>PZ</td> </tr> <tr> <td>VI1996A0</td> <td>VITE M5X35 TCEI ZN</td> <td>7</td> <td>PZ</td> </tr> <tr> <td>VM1794A0</td> <td>FASCETTA 250X4.8 PA66 NERA</td> <td>2</td> <td>PZ</td> </tr> <tr> <td>VM2103A0</td> <td>PIASTRINA FERMAFASCE TTA</td> <td>2</td> <td>PZ</td> </tr> <tr> <td>VM2259A1</td> <td>TAPPO INF SX PORTA S6</td> <td>1</td> <td>PZ</td> </tr> <tr> <td>VM2261A1</td> <td>TAPPO INF DX PORTA S6</td> <td>1</td> <td>PZ</td> </tr> </tbody> </table>	Codice	Descrizione	Qtà	UM	0B1126A0	TRAVERSO INFERIORE PORTA 860 M	1	PZ	RC1200A0	MOLLA A COMPRESSIO NE DE4 DF0.5 H24	2	PZ	VI1220A1	VITE AUTOFILETTA NTE 4.2X11 TCS+ MARUTE	1	PZ	VI1996A0	VITE M5X35 TCEI ZN	7	PZ	VM1794A0	FASCETTA 250X4.8 PA66 NERA	2	PZ	VM2103A0	PIASTRINA FERMAFASCE TTA	2	PZ	VM2259A1	TAPPO INF SX PORTA S6	1	PZ	VM2261A1	TAPPO INF DX PORTA S6	1	PZ
Codice	Descrizione	Qtà	UM																																						
0B1126A0	TRAVERSO INFERIORE PORTA 860 M	1	PZ																																						
RC1200A0	MOLLA A COMPRESSIO NE DE4 DF0.5 H24	2	PZ																																						
VI1220A1	VITE AUTOFILETTA NTE 4.2X11 TCS+ MARUTE	1	PZ																																						
VI1996A0	VITE M5X35 TCEI ZN	7	PZ																																						
VM1794A0	FASCETTA 250X4.8 PA66 NERA	2	PZ																																						
VM2103A0	PIASTRINA FERMAFASCE TTA	2	PZ																																						
VM2259A1	TAPPO INF SX PORTA S6	1	PZ																																						
VM2261A1	TAPPO INF DX PORTA S6	1	PZ																																						

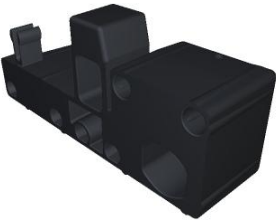

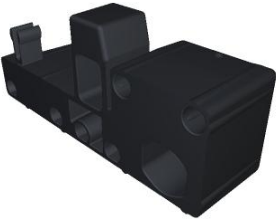
COMPONENTE			RICAMBIO																																																			
Codice	Descrizione	Immagine	Codice	Descrizione	Lista componenti																																																	
VM2259A	TAPPO INF SX PORTA S6		K0B1126AR	KIT TRAVERSO INF. PORTA BAKERTOP DX	<table border="1"> <thead> <tr> <th>Codice</th> <th>Descrizione</th> <th>Qtà</th> <th>UM</th> </tr> </thead> <tbody> <tr> <td>VM2267A0</td> <td>CORSOIO SISTEMA FERMA VETRO INT</td> <td>1</td> <td>PZ</td> </tr> <tr> <td>VM2269A0</td> <td>TAPPO SISTEMA FERMA VETRO INT</td> <td>1</td> <td>PZ</td> </tr> <tr> <td>VM2274A0</td> <td>BOCCOLA SCANALATA</td> <td>1</td> <td>PZ</td> </tr> <tr> <td>VM2305A0</td> <td>NOTTOLINO FISSAGGIO TAPPI PORTE MM</td> <td>7</td> <td>PZ</td> </tr> </tbody> </table>	Codice	Descrizione	Qtà	UM	VM2267A0	CORSOIO SISTEMA FERMA VETRO INT	1	PZ	VM2269A0	TAPPO SISTEMA FERMA VETRO INT	1	PZ	VM2274A0	BOCCOLA SCANALATA	1	PZ	VM2305A0	NOTTOLINO FISSAGGIO TAPPI PORTE MM	7	PZ																													
			Codice	Descrizione	Qtà	UM																																																
VM2267A0	CORSOIO SISTEMA FERMA VETRO INT	1	PZ																																																			
VM2269A0	TAPPO SISTEMA FERMA VETRO INT	1	PZ																																																			
VM2274A0	BOCCOLA SCANALATA	1	PZ																																																			
VM2305A0	NOTTOLINO FISSAGGIO TAPPI PORTE MM	7	PZ																																																			
K0B1126AL	KIT TRAVERSO INF PORTA BAKERTOP SX	<table border="1"> <thead> <tr> <th>Codice</th> <th>Descrizione</th> <th>Qtà</th> <th>UM</th> </tr> </thead> <tbody> <tr> <td>0B1126A0</td> <td>TRAVERSO INFERIORE PORTA 860 M</td> <td>1</td> <td>PZ</td> </tr> <tr> <td>RC1200A0</td> <td>MOLLA A COMPRESSIO NE DE4 DF0.5 H24</td> <td>2</td> <td>PZ</td> </tr> <tr> <td>VI1220A1</td> <td>VITE AUTOFILETTA NTE 4.2X11 TCS+ MARUTE</td> <td>1</td> <td>PZ</td> </tr> <tr> <td>VI1996A0</td> <td>VITE M5X35 TCEI ZN</td> <td>7</td> <td>PZ</td> </tr> <tr> <td>VM1794A0</td> <td>FASCETTA 250X4.8 PA66 NERA</td> <td>2</td> <td>PZ</td> </tr> <tr> <td>VM2103A0</td> <td>PIASTRINA FERMAFASCE TTA</td> <td>2</td> <td>PZ</td> </tr> <tr> <td>VM2267A0</td> <td>CORSOIO SISTEMA FERMA VETRO INT</td> <td>1</td> <td>PZ</td> </tr> <tr> <td>VM2269A0</td> <td>TAPPO SISTEMA FERMA VETRO INT</td> <td>1</td> <td>PZ</td> </tr> <tr> <td>VM2274A0</td> <td>BOCCOLA SCANALATA</td> <td>1</td> <td>PZ</td> </tr> <tr> <td>VM2305A0</td> <td>NOTTOLINO FISSAGGIO TAPPI PORTE MM</td> <td>7</td> <td>PZ</td> </tr> <tr> <td>VM2384A0</td> <td>TAPPO INF DX PORTA MM LEFT</td> <td>1</td> <td>PZ</td> </tr> <tr> <td>VM2386A1</td> <td>TAPPO INF SX PORTA MM LEFT</td> <td>1</td> <td>PZ</td> </tr> </tbody> </table>	Codice	Descrizione	Qtà	UM	0B1126A0	TRAVERSO INFERIORE PORTA 860 M	1	PZ	RC1200A0	MOLLA A COMPRESSIO NE DE4 DF0.5 H24	2	PZ	VI1220A1	VITE AUTOFILETTA NTE 4.2X11 TCS+ MARUTE	1	PZ	VI1996A0	VITE M5X35 TCEI ZN	7	PZ	VM1794A0	FASCETTA 250X4.8 PA66 NERA	2	PZ	VM2103A0	PIASTRINA FERMAFASCE TTA	2	PZ	VM2267A0	CORSOIO SISTEMA FERMA VETRO INT	1	PZ	VM2269A0	TAPPO SISTEMA FERMA VETRO INT	1	PZ	VM2274A0	BOCCOLA SCANALATA	1	PZ	VM2305A0	NOTTOLINO FISSAGGIO TAPPI PORTE MM	7	PZ	VM2384A0	TAPPO INF DX PORTA MM LEFT	1	PZ	VM2386A1	TAPPO INF SX PORTA MM LEFT	1	PZ
Codice	Descrizione	Qtà	UM																																																			
0B1126A0	TRAVERSO INFERIORE PORTA 860 M	1	PZ																																																			
RC1200A0	MOLLA A COMPRESSIO NE DE4 DF0.5 H24	2	PZ																																																			
VI1220A1	VITE AUTOFILETTA NTE 4.2X11 TCS+ MARUTE	1	PZ																																																			
VI1996A0	VITE M5X35 TCEI ZN	7	PZ																																																			
VM1794A0	FASCETTA 250X4.8 PA66 NERA	2	PZ																																																			
VM2103A0	PIASTRINA FERMAFASCE TTA	2	PZ																																																			
VM2267A0	CORSOIO SISTEMA FERMA VETRO INT	1	PZ																																																			
VM2269A0	TAPPO SISTEMA FERMA VETRO INT	1	PZ																																																			
VM2274A0	BOCCOLA SCANALATA	1	PZ																																																			
VM2305A0	NOTTOLINO FISSAGGIO TAPPI PORTE MM	7	PZ																																																			
VM2384A0	TAPPO INF DX PORTA MM LEFT	1	PZ																																																			
VM2386A1	TAPPO INF SX PORTA MM LEFT	1	PZ																																																			

COMPONENTE			RICAMBIO																																																																																	
Codice	Descrizione	Immagine	Codice	Descrizione	Lista componenti																																																																															
VM2259A	TAPPO INF SX PORTA S6		K0B1122AR	KIT TRAVERSO INF. PORTA CHEFTOP D	<table border="1"> <thead> <tr> <th>Codice</th> <th>Descrizione</th> <th>Qtà</th> <th>UM</th> </tr> </thead> <tbody> <tr> <td>0B1122A0</td> <td>TRAVERSO INFERIORE PORTA 750 M</td> <td>1</td> <td>PZ</td> </tr> <tr> <td>RC1200A0</td> <td>MOLLA A COMPRESSIO NE DE4 DF0.5 H24</td> <td>2</td> <td>PZ</td> </tr> <tr> <td>VI1220A1</td> <td>VITE AUTOFIETTA NTE 4.2X11 TCS+ MARUTE</td> <td>1</td> <td>PZ</td> </tr> <tr> <td>VI1996A0</td> <td>VITE M5X35 TCEI ZN</td> <td>7</td> <td>PZ</td> </tr> <tr> <td>VM1794A0</td> <td>FASCETTA 250X4.8 PA66 NERA</td> <td>2</td> <td>PZ</td> </tr> <tr> <td>VM2103A0</td> <td>PIASTRINA FERMAFASCE TTA</td> <td>2</td> <td>PZ</td> </tr> <tr> <td>VM2259A1</td> <td>TAPPO INF SX PORTA S6</td> <td>1</td> <td>PZ</td> </tr> <tr> <td>VM2261A1</td> <td>TAPPO INF DX PORTA S6</td> <td>1</td> <td>PZ</td> </tr> <tr> <td>VM2267A0</td> <td>CORSOIO SISTEMA FERMA VETRO INT</td> <td>1</td> <td>PZ</td> </tr> <tr> <td>VM2269A0</td> <td>TAPPO SISTEMA FERMA VETRO INT</td> <td>1</td> <td>PZ</td> </tr> <tr> <td>VM2274A0</td> <td>BOCCOLA SCANALATA</td> <td>1</td> <td>PZ</td> </tr> <tr> <td>VM2305A0</td> <td>NOTTOLINO FISSAGGIO TAPPI PORTE MM</td> <td>7</td> <td>PZ</td> </tr> </tbody> </table>	Codice	Descrizione	Qtà	UM	0B1122A0	TRAVERSO INFERIORE PORTA 750 M	1	PZ	RC1200A0	MOLLA A COMPRESSIO NE DE4 DF0.5 H24	2	PZ	VI1220A1	VITE AUTOFIETTA NTE 4.2X11 TCS+ MARUTE	1	PZ	VI1996A0	VITE M5X35 TCEI ZN	7	PZ	VM1794A0	FASCETTA 250X4.8 PA66 NERA	2	PZ	VM2103A0	PIASTRINA FERMAFASCE TTA	2	PZ	VM2259A1	TAPPO INF SX PORTA S6	1	PZ	VM2261A1	TAPPO INF DX PORTA S6	1	PZ	VM2267A0	CORSOIO SISTEMA FERMA VETRO INT	1	PZ	VM2269A0	TAPPO SISTEMA FERMA VETRO INT	1	PZ	VM2274A0	BOCCOLA SCANALATA	1	PZ	VM2305A0	NOTTOLINO FISSAGGIO TAPPI PORTE MM	7	PZ	K0B1122AL	KIT TRAVERSO INF. PORTA CHEFTOP MM SX	<table border="1"> <thead> <tr> <th>Codice</th> <th>Descrizione</th> <th>Qtà</th> <th>UM</th> </tr> </thead> <tbody> <tr> <td>0B1122A0</td> <td>TRAVERSO INFERIORE PORTA 750 M</td> <td>1</td> <td>PZ</td> </tr> <tr> <td>RC1200A0</td> <td>MOLLA A COMPRESSIO NE DE4 DF0.5 H24</td> <td>2</td> <td>PZ</td> </tr> <tr> <td>VI1220A1</td> <td>VITE AUTOFIETTA NTE 4.2X11 TCS+ MARUTE</td> <td>1</td> <td>PZ</td> </tr> <tr> <td>VI1996A0</td> <td>VITE M5X35 TCEI ZN</td> <td>7</td> <td>PZ</td> </tr> <tr> <td>VM1794A0</td> <td>FASCETTA 250X4.8 PA66 NERA</td> <td>2</td> <td>PZ</td> </tr> </tbody> </table>	Codice	Descrizione	Qtà	UM	0B1122A0	TRAVERSO INFERIORE PORTA 750 M	1	PZ	RC1200A0	MOLLA A COMPRESSIO NE DE4 DF0.5 H24	2	PZ	VI1220A1	VITE AUTOFIETTA NTE 4.2X11 TCS+ MARUTE	1	PZ	VI1996A0	VITE M5X35 TCEI ZN	7	PZ	VM1794A0	FASCETTA 250X4.8 PA66 NERA	2	PZ
			Codice	Descrizione	Qtà	UM																																																																														
0B1122A0	TRAVERSO INFERIORE PORTA 750 M	1	PZ																																																																																	
RC1200A0	MOLLA A COMPRESSIO NE DE4 DF0.5 H24	2	PZ																																																																																	
VI1220A1	VITE AUTOFIETTA NTE 4.2X11 TCS+ MARUTE	1	PZ																																																																																	
VI1996A0	VITE M5X35 TCEI ZN	7	PZ																																																																																	
VM1794A0	FASCETTA 250X4.8 PA66 NERA	2	PZ																																																																																	
VM2103A0	PIASTRINA FERMAFASCE TTA	2	PZ																																																																																	
VM2259A1	TAPPO INF SX PORTA S6	1	PZ																																																																																	
VM2261A1	TAPPO INF DX PORTA S6	1	PZ																																																																																	
VM2267A0	CORSOIO SISTEMA FERMA VETRO INT	1	PZ																																																																																	
VM2269A0	TAPPO SISTEMA FERMA VETRO INT	1	PZ																																																																																	
VM2274A0	BOCCOLA SCANALATA	1	PZ																																																																																	
VM2305A0	NOTTOLINO FISSAGGIO TAPPI PORTE MM	7	PZ																																																																																	
Codice	Descrizione	Qtà	UM																																																																																	
0B1122A0	TRAVERSO INFERIORE PORTA 750 M	1	PZ																																																																																	
RC1200A0	MOLLA A COMPRESSIO NE DE4 DF0.5 H24	2	PZ																																																																																	
VI1220A1	VITE AUTOFIETTA NTE 4.2X11 TCS+ MARUTE	1	PZ																																																																																	
VI1996A0	VITE M5X35 TCEI ZN	7	PZ																																																																																	
VM1794A0	FASCETTA 250X4.8 PA66 NERA	2	PZ																																																																																	

COMPONENTE			RICAMBIO																																		
<i>Codice</i>	<i>Descrizione</i>	<i>Immagine</i>	<i>Codice</i>	<i>Descrizione</i>	<i>Lista componenti</i>																																
VM2259A	TAPPO INF SX PORTA S6		K0B1122AL	KIT TRAVERSO INF. PORTA CHEFTOP MM SX	<table border="1"> <thead> <tr> <th>Codice</th> <th>Descrizione</th> <th>Qtà</th> <th>UM</th> </tr> </thead> <tbody> <tr> <td>VM2103A0</td> <td>PIASTRINA FERMAFASCE TTA</td> <td>2</td> <td>PZ</td> </tr> <tr> <td>VM2267A0</td> <td>CORSOIO SISTEMA FERMA VETRO INT</td> <td>1</td> <td>PZ</td> </tr> <tr> <td>VM2269A0</td> <td>TAPPO SISTEMA FERMA VETRO INT</td> <td>1</td> <td>PZ</td> </tr> <tr> <td>VM2274A0</td> <td>BOCCOLA SCANALATA</td> <td>1</td> <td>PZ</td> </tr> <tr> <td>VM2305A0</td> <td>NOTTOLINO FISSAGGIO TAPPI PORTE MM</td> <td>7</td> <td>PZ</td> </tr> <tr> <td>VM2384A0</td> <td>TAPPO INF DX PORTA MM LEFT</td> <td>1</td> <td>PZ</td> </tr> <tr> <td>VM2386A1</td> <td>TAPPO INF SX PORTA MM LEFT</td> <td>1</td> <td>PZ</td> </tr> </tbody> </table>	Codice	Descrizione	Qtà	UM	VM2103A0	PIASTRINA FERMAFASCE TTA	2	PZ	VM2267A0	CORSOIO SISTEMA FERMA VETRO INT	1	PZ	VM2269A0	TAPPO SISTEMA FERMA VETRO INT	1	PZ	VM2274A0	BOCCOLA SCANALATA	1	PZ	VM2305A0	NOTTOLINO FISSAGGIO TAPPI PORTE MM	7	PZ	VM2384A0	TAPPO INF DX PORTA MM LEFT	1	PZ	VM2386A1	TAPPO INF SX PORTA MM LEFT	1	PZ
Codice	Descrizione	Qtà	UM																																		
VM2103A0	PIASTRINA FERMAFASCE TTA	2	PZ																																		
VM2267A0	CORSOIO SISTEMA FERMA VETRO INT	1	PZ																																		
VM2269A0	TAPPO SISTEMA FERMA VETRO INT	1	PZ																																		
VM2274A0	BOCCOLA SCANALATA	1	PZ																																		
VM2305A0	NOTTOLINO FISSAGGIO TAPPI PORTE MM	7	PZ																																		
VM2384A0	TAPPO INF DX PORTA MM LEFT	1	PZ																																		
VM2386A1	TAPPO INF SX PORTA MM LEFT	1	PZ																																		
VM2305A	NOTTOLINO FISSAGGIO TAPPI PORTE MM		VM2305A0	NOTTOLINO FISSAGGIO TAPPI PORTE MM																																	
VM2267A	CORSOIO SISTEMA FERMA VETRO INT		VM2267A0	CORSOIO SISTEMA FERMA VETRO INT																																	
VM2269A	TAPPO SISTEMA FERMA VETRO INT		KVM2269A	KIT TAPPO SISTEMA FERMA VETRO INTERNO	<table border="1"> <thead> <tr> <th>Codice</th> <th>Descrizione</th> <th>Qtà</th> <th>UM</th> </tr> </thead> <tbody> <tr> <td>VM2269A0</td> <td>TAPPO SISTEMA FERMA VETRO INT</td> <td>2</td> <td>PZ</td> </tr> </tbody> </table>	Codice	Descrizione	Qtà	UM	VM2269A0	TAPPO SISTEMA FERMA VETRO INT	2	PZ																								
Codice	Descrizione	Qtà	UM																																		
VM2269A0	TAPPO SISTEMA FERMA VETRO INT	2	PZ																																		



COMPONENTE			RICAMBIO											
Codice	Descrizione	Immagine	Codice	Descrizione	Lista componenti									
VE1030A	CALAMITA D=22,9MM PER MICROPORTA		KVE1030A	KIT MAGNETE MICROPORTA 2 PZ	<table border="1"> <thead> <tr> <th>Codice</th> <th>Descrizione</th> <th>Qtà</th> <th>UM</th> </tr> </thead> <tbody> <tr> <td>VE1030A1</td> <td>CALAMITA D=22,9MM PER MICROPORTA</td> <td>2</td> <td>PZ</td> </tr> </tbody> </table>	Codice	Descrizione	Qtà	UM	VE1030A1	CALAMITA D=22,9MM PER MICROPORTA	2	PZ	
			Codice	Descrizione	Qtà	UM								
VE1030A1	CALAMITA D=22,9MM PER MICROPORTA	2	PZ											
KVE1020A	KIT MICROPORTA	<table border="1"> <thead> <tr> <th>Codice</th> <th>Descrizione</th> <th>Qtà</th> <th>UM</th> </tr> </thead> <tbody> <tr> <td>VE1020A2</td> <td>MICROINTERR UTTORE PORTA MAGNETICO</td> <td>1</td> <td>PZ</td> </tr> <tr> <td>VE1030A1</td> <td>CALAMITA D=22,9MM PER MICROPORTA</td> <td>4</td> <td>PZ</td> </tr> </tbody> </table>	Codice	Descrizione	Qtà	UM	VE1020A2	MICROINTERR UTTORE PORTA MAGNETICO	1	PZ	VE1030A1	CALAMITA D=22,9MM PER MICROPORTA	4	PZ
Codice	Descrizione	Qtà	UM											
VE1020A2	MICROINTERR UTTORE PORTA MAGNETICO	1	PZ											
VE1030A1	CALAMITA D=22,9MM PER MICROPORTA	4	PZ											
VM2268A	TAPPO COPRI CALAMITA PORTA		KVM2268A	KIT TAPPO COPRI CALAMITA PORTA	<table border="1"> <thead> <tr> <th>Codice</th> <th>Descrizione</th> <th>Qtà</th> <th>UM</th> </tr> </thead> <tbody> <tr> <td>VM2268A0</td> <td>TAPPO COPRI CALAMITA PORTA</td> <td>1</td> <td>PZ</td> </tr> </tbody> </table>	Codice	Descrizione	Qtà	UM	VM2268A0	TAPPO COPRI CALAMITA PORTA	1	PZ	
Codice	Descrizione	Qtà	UM											
VM2268A0	TAPPO COPRI CALAMITA PORTA	1	PZ											
VI1996A	VITE M5X35 TCEI ZN		VI1996A0	VITE M5X35 TCEI ZN										
VM2262A	TAPPO SUP DX PORTA S6		KVM2262A	KIT TAPPO SUP. DX PORTA MIND MAPS	<table border="1"> <thead> <tr> <th>Codice</th> <th>Descrizione</th> <th>Qtà</th> <th>UM</th> </tr> </thead> <tbody> <tr> <td>VM2262A1</td> <td>TAPPO SUP DX PORTA S6</td> <td>1</td> <td>PZ</td> </tr> </tbody> </table>	Codice	Descrizione	Qtà	UM	VM2262A1	TAPPO SUP DX PORTA S6	1	PZ	
Codice	Descrizione	Qtà	UM											
VM2262A1	TAPPO SUP DX PORTA S6	1	PZ											

COMPONENTE			RICAMBIO														
Codice	Descrizione	Immagine	Codice	Descrizione	Lista componenti												
VM2305A	NOTTOLINO FISSAGGIO TAPPI PORTE MM		VM2305A0	NOTTOLINO FISSAGGIO TAPPI PORTE MM													
VM2267A	CORSOIO SISTEMA FERMA VETRO INT		VM2267A0	CORSOIO SISTEMA FERMA VETRO INT													
VM2269A	TAPPO SISTEMA FERMA VETRO INT		KVM2269A	KIT TAPPO SISTEMA FERMA VETRO INTERNO	<table border="1"> <thead> <tr> <th>Codice</th> <th>Descrizione</th> <th>Qtà</th> <th>UM</th> </tr> </thead> <tbody> <tr> <td>VM2269A0</td> <td>TAPPO SISTEMA FERMA VETRO INT</td> <td>2</td> <td>PZ</td> </tr> </tbody> </table>	Codice	Descrizione	Qtà	UM	VM2269A0	TAPPO SISTEMA FERMA VETRO INT	2	PZ				
Codice	Descrizione	Qtà	UM														
VM2269A0	TAPPO SISTEMA FERMA VETRO INT	2	PZ														
VE1030A	CALAMITA D=22,9MM PER MICROPORTA		KVE1030A	KIT MAGNETE MICROPORTA 2 PZ	<table border="1"> <thead> <tr> <th>Codice</th> <th>Descrizione</th> <th>Qtà</th> <th>UM</th> </tr> </thead> <tbody> <tr> <td>VE1030A1</td> <td>CALAMITA D=22,9MM PER MICROPORTA</td> <td>2</td> <td>PZ</td> </tr> </tbody> </table>	Codice	Descrizione	Qtà	UM	VE1030A1	CALAMITA D=22,9MM PER MICROPORTA	2	PZ				
Codice	Descrizione	Qtà	UM														
VE1030A1	CALAMITA D=22,9MM PER MICROPORTA	2	PZ														
			KVE1020A	KIT MICROPORTA	<table border="1"> <thead> <tr> <th>Codice</th> <th>Descrizione</th> <th>Qtà</th> <th>UM</th> </tr> </thead> <tbody> <tr> <td>VE1020A2</td> <td>MICROINTERR UTTORE PORTA MAGNETICO</td> <td>1</td> <td>PZ</td> </tr> <tr> <td>VE1030A1</td> <td>CALAMITA D=22,9MM PER MICROPORTA</td> <td>4</td> <td>PZ</td> </tr> </tbody> </table>	Codice	Descrizione	Qtà	UM	VE1020A2	MICROINTERR UTTORE PORTA MAGNETICO	1	PZ	VE1030A1	CALAMITA D=22,9MM PER MICROPORTA	4	PZ
Codice	Descrizione	Qtà	UM														
VE1020A2	MICROINTERR UTTORE PORTA MAGNETICO	1	PZ														
VE1030A1	CALAMITA D=22,9MM PER MICROPORTA	4	PZ														





COMPONENTE			RICAMBIO																																																						
Codice	Descrizione	Immagine	Codice	Descrizione	Lista componenti																																																				
VM2268A	TAPPO COPRI CALAMITA PORTA		KVM2268A	KIT TAPPO COPRI CALAMITA PORTA	<table border="1"> <thead> <tr> <th>Codice</th> <th>Descrizione</th> <th>Qtà</th> <th>UM</th> </tr> </thead> <tbody> <tr> <td>VM2268A0</td> <td>TAPPO COPRI CALAMITA PORTA</td> <td>1</td> <td>PZ</td> </tr> </tbody> </table>	Codice	Descrizione	Qtà	UM	VM2268A0	TAPPO COPRI CALAMITA PORTA	1	PZ																																												
Codice	Descrizione	Qtà	UM																																																						
VM2268A0	TAPPO COPRI CALAMITA PORTA	1	PZ																																																						
VI1996A	VITE M5X35 TCEI ZN		VI1996A0	VITE M5X35 TCEI ZN																																																					
VM2261A	TAPPO INF DX PORTA S6		<p>KVM2261A</p> <p>K0B1126AR</p>	<p>KIT TAPPO INF. DX PORTA MIND.MAPS</p> <p>KIT TRAVERSO INF. PORTA BAKERTOP DX</p>	<table border="1"> <thead> <tr> <th>Codice</th> <th>Descrizione</th> <th>Qtà</th> <th>UM</th> </tr> </thead> <tbody> <tr> <td>VI1996A0</td> <td>VITE M5X35 TCEI ZN</td> <td>3</td> <td>PZ</td> </tr> <tr> <td>VM2261A1</td> <td>TAPPO INF DX PORTA S6</td> <td>1</td> <td>PZ</td> </tr> <tr> <td>VM2305A0</td> <td>NOTTOLINO FISSAGGIO TAPPI PORTE MM</td> <td>3</td> <td>PZ</td> </tr> </tbody> </table> <table border="1"> <thead> <tr> <th>Codice</th> <th>Descrizione</th> <th>Qtà</th> <th>UM</th> </tr> </thead> <tbody> <tr> <td>0B1126A0</td> <td>TRAVERSO INFERIORE PORTA 860 M</td> <td>1</td> <td>PZ</td> </tr> <tr> <td>RC1200A0</td> <td>MOLLA A COMPRESSIO NE DE4 DF0.5 H24</td> <td>2</td> <td>PZ</td> </tr> <tr> <td>VI1220A1</td> <td>VITE AUTOFILETTA NTE 4.2X11 TCS+ MARUTE</td> <td>1</td> <td>PZ</td> </tr> <tr> <td>VI1996A0</td> <td>VITE M5X35 TCEI ZN</td> <td>7</td> <td>PZ</td> </tr> <tr> <td>VM1794A0</td> <td>FASCETTA 250X4.8 PA66 NERA</td> <td>2</td> <td>PZ</td> </tr> <tr> <td>VM2103A0</td> <td>PIASTRINA FERMAFASCE TTA</td> <td>2</td> <td>PZ</td> </tr> <tr> <td>VM2259A1</td> <td>TAPPO INF SX PORTA S6</td> <td>1</td> <td>PZ</td> </tr> <tr> <td>VM2261A1</td> <td>TAPPO INF DX PORTA S6</td> <td>1</td> <td>PZ</td> </tr> </tbody> </table>	Codice	Descrizione	Qtà	UM	VI1996A0	VITE M5X35 TCEI ZN	3	PZ	VM2261A1	TAPPO INF DX PORTA S6	1	PZ	VM2305A0	NOTTOLINO FISSAGGIO TAPPI PORTE MM	3	PZ	Codice	Descrizione	Qtà	UM	0B1126A0	TRAVERSO INFERIORE PORTA 860 M	1	PZ	RC1200A0	MOLLA A COMPRESSIO NE DE4 DF0.5 H24	2	PZ	VI1220A1	VITE AUTOFILETTA NTE 4.2X11 TCS+ MARUTE	1	PZ	VI1996A0	VITE M5X35 TCEI ZN	7	PZ	VM1794A0	FASCETTA 250X4.8 PA66 NERA	2	PZ	VM2103A0	PIASTRINA FERMAFASCE TTA	2	PZ	VM2259A1	TAPPO INF SX PORTA S6	1	PZ	VM2261A1	TAPPO INF DX PORTA S6	1	PZ
Codice	Descrizione	Qtà	UM																																																						
VI1996A0	VITE M5X35 TCEI ZN	3	PZ																																																						
VM2261A1	TAPPO INF DX PORTA S6	1	PZ																																																						
VM2305A0	NOTTOLINO FISSAGGIO TAPPI PORTE MM	3	PZ																																																						
Codice	Descrizione	Qtà	UM																																																						
0B1126A0	TRAVERSO INFERIORE PORTA 860 M	1	PZ																																																						
RC1200A0	MOLLA A COMPRESSIO NE DE4 DF0.5 H24	2	PZ																																																						
VI1220A1	VITE AUTOFILETTA NTE 4.2X11 TCS+ MARUTE	1	PZ																																																						
VI1996A0	VITE M5X35 TCEI ZN	7	PZ																																																						
VM1794A0	FASCETTA 250X4.8 PA66 NERA	2	PZ																																																						
VM2103A0	PIASTRINA FERMAFASCE TTA	2	PZ																																																						
VM2259A1	TAPPO INF SX PORTA S6	1	PZ																																																						
VM2261A1	TAPPO INF DX PORTA S6	1	PZ																																																						

COMPONENTE			RICAMBIO																																																			
Codice	Descrizione	Immagine	Codice	Descrizione	Lista componenti																																																	
VM2261A	TAPPO INF DX PORTA S6		K0B1126AR	KIT TRAVERSO INF. PORTA BAKERTOP DX	<table border="1"> <thead> <tr> <th>Codice</th> <th>Descrizione</th> <th>Qtà</th> <th>UM</th> </tr> </thead> <tbody> <tr> <td>VM2267A0</td> <td>CORSOIO SISTEMA FERMA VETRO INT</td> <td>1</td> <td>PZ</td> </tr> <tr> <td>VM2269A0</td> <td>TAPPO SISTEMA FERMA VETRO INT</td> <td>1</td> <td>PZ</td> </tr> <tr> <td>VM2274A0</td> <td>BOCCOLA SCANALATA</td> <td>1</td> <td>PZ</td> </tr> <tr> <td>VM2305A0</td> <td>NOTTOLINO FISSAGGIO TAPPI PORTE MM</td> <td>7</td> <td>PZ</td> </tr> </tbody> </table>	Codice	Descrizione	Qtà	UM	VM2267A0	CORSOIO SISTEMA FERMA VETRO INT	1	PZ	VM2269A0	TAPPO SISTEMA FERMA VETRO INT	1	PZ	VM2274A0	BOCCOLA SCANALATA	1	PZ	VM2305A0	NOTTOLINO FISSAGGIO TAPPI PORTE MM	7	PZ																													
			Codice	Descrizione	Qtà	UM																																																
VM2267A0	CORSOIO SISTEMA FERMA VETRO INT	1	PZ																																																			
VM2269A0	TAPPO SISTEMA FERMA VETRO INT	1	PZ																																																			
VM2274A0	BOCCOLA SCANALATA	1	PZ																																																			
VM2305A0	NOTTOLINO FISSAGGIO TAPPI PORTE MM	7	PZ																																																			
K0B1126AL	KIT TRAVERSO INF PORTA BAKERTOP SX	<table border="1"> <thead> <tr> <th>Codice</th> <th>Descrizione</th> <th>Qtà</th> <th>UM</th> </tr> </thead> <tbody> <tr> <td>0B1126A0</td> <td>TRAVERSO INFERIORE PORTA 860 M</td> <td>1</td> <td>PZ</td> </tr> <tr> <td>RC1200A0</td> <td>MOLLA A COMPRESSIO NE DE4 DF0.5 H24</td> <td>2</td> <td>PZ</td> </tr> <tr> <td>VI1220A1</td> <td>VITE AUTOFILETTA NTE 4.2X11 TCS+ MARUTE</td> <td>1</td> <td>PZ</td> </tr> <tr> <td>VI1996A0</td> <td>VITE M5X35 TCEI ZN</td> <td>7</td> <td>PZ</td> </tr> <tr> <td>VM1794A0</td> <td>FASCETTA 250X4.8 PA66 NERA</td> <td>2</td> <td>PZ</td> </tr> <tr> <td>VM2103A0</td> <td>PIASTRINA FERMAFASCE TTA</td> <td>2</td> <td>PZ</td> </tr> <tr> <td>VM2267A0</td> <td>CORSOIO SISTEMA FERMA VETRO INT</td> <td>1</td> <td>PZ</td> </tr> <tr> <td>VM2269A0</td> <td>TAPPO SISTEMA FERMA VETRO INT</td> <td>1</td> <td>PZ</td> </tr> <tr> <td>VM2274A0</td> <td>BOCCOLA SCANALATA</td> <td>1</td> <td>PZ</td> </tr> <tr> <td>VM2305A0</td> <td>NOTTOLINO FISSAGGIO TAPPI PORTE MM</td> <td>7</td> <td>PZ</td> </tr> <tr> <td>VM2384A0</td> <td>TAPPO INF DX PORTA MM LEFT</td> <td>1</td> <td>PZ</td> </tr> <tr> <td>VM2386A1</td> <td>TAPPO INF SX PORTA MM LEFT</td> <td>1</td> <td>PZ</td> </tr> </tbody> </table>	Codice	Descrizione	Qtà	UM	0B1126A0	TRAVERSO INFERIORE PORTA 860 M	1	PZ	RC1200A0	MOLLA A COMPRESSIO NE DE4 DF0.5 H24	2	PZ	VI1220A1	VITE AUTOFILETTA NTE 4.2X11 TCS+ MARUTE	1	PZ	VI1996A0	VITE M5X35 TCEI ZN	7	PZ	VM1794A0	FASCETTA 250X4.8 PA66 NERA	2	PZ	VM2103A0	PIASTRINA FERMAFASCE TTA	2	PZ	VM2267A0	CORSOIO SISTEMA FERMA VETRO INT	1	PZ	VM2269A0	TAPPO SISTEMA FERMA VETRO INT	1	PZ	VM2274A0	BOCCOLA SCANALATA	1	PZ	VM2305A0	NOTTOLINO FISSAGGIO TAPPI PORTE MM	7	PZ	VM2384A0	TAPPO INF DX PORTA MM LEFT	1	PZ	VM2386A1	TAPPO INF SX PORTA MM LEFT	1	PZ
Codice	Descrizione	Qtà	UM																																																			
0B1126A0	TRAVERSO INFERIORE PORTA 860 M	1	PZ																																																			
RC1200A0	MOLLA A COMPRESSIO NE DE4 DF0.5 H24	2	PZ																																																			
VI1220A1	VITE AUTOFILETTA NTE 4.2X11 TCS+ MARUTE	1	PZ																																																			
VI1996A0	VITE M5X35 TCEI ZN	7	PZ																																																			
VM1794A0	FASCETTA 250X4.8 PA66 NERA	2	PZ																																																			
VM2103A0	PIASTRINA FERMAFASCE TTA	2	PZ																																																			
VM2267A0	CORSOIO SISTEMA FERMA VETRO INT	1	PZ																																																			
VM2269A0	TAPPO SISTEMA FERMA VETRO INT	1	PZ																																																			
VM2274A0	BOCCOLA SCANALATA	1	PZ																																																			
VM2305A0	NOTTOLINO FISSAGGIO TAPPI PORTE MM	7	PZ																																																			
VM2384A0	TAPPO INF DX PORTA MM LEFT	1	PZ																																																			
VM2386A1	TAPPO INF SX PORTA MM LEFT	1	PZ																																																			

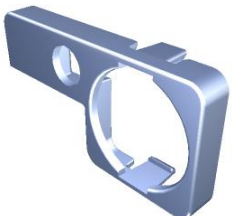

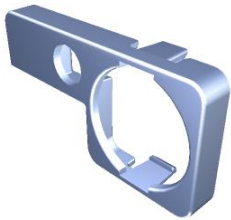

COMPONENTE			RICAMBIO																																																																																	
Codice	Descrizione	Immagine	Codice	Descrizione	Lista componenti																																																																															
VM2261A	TAPPO INF DX PORTA S6		K0B1122AR	KIT TRAVERSO INF. PORTA CHEFTOP D	<table border="1"> <thead> <tr> <th>Codice</th> <th>Descrizione</th> <th>Qtà</th> <th>UM</th> </tr> </thead> <tbody> <tr> <td>0B1122A0</td> <td>TRAVERSO INFERIORE PORTA 750 M</td> <td>1</td> <td>PZ</td> </tr> <tr> <td>RC1200A0</td> <td>MOLLA A COMPRESSIO NE DE4 DF0.5 H24</td> <td>2</td> <td>PZ</td> </tr> <tr> <td>VI1220A1</td> <td>VITE AUTOFIETTA NTE 4.2X11 TCS+ MARUTE</td> <td>1</td> <td>PZ</td> </tr> <tr> <td>VI1996A0</td> <td>VITE M5X35 TCEI ZN</td> <td>7</td> <td>PZ</td> </tr> <tr> <td>VM1794A0</td> <td>FASCETTA 250X4.8 PA66 NERA</td> <td>2</td> <td>PZ</td> </tr> <tr> <td>VM2103A0</td> <td>PIASTRINA FERMAFASCE TTA</td> <td>2</td> <td>PZ</td> </tr> <tr> <td>VM2259A1</td> <td>TAPPO INF SX PORTA S6</td> <td>1</td> <td>PZ</td> </tr> <tr> <td>VM2261A1</td> <td>TAPPO INF DX PORTA S6</td> <td>1</td> <td>PZ</td> </tr> <tr> <td>VM2267A0</td> <td>CORSOIO SISTEMA FERMA VETRO INT</td> <td>1</td> <td>PZ</td> </tr> <tr> <td>VM2269A0</td> <td>TAPPO SISTEMA FERMA VETRO INT</td> <td>1</td> <td>PZ</td> </tr> <tr> <td>VM2274A0</td> <td>BOCCOLA SCANALATA</td> <td>1</td> <td>PZ</td> </tr> <tr> <td>VM2305A0</td> <td>NOTTOLINO FISSAGGIO TAPPI PORTE MM</td> <td>7</td> <td>PZ</td> </tr> </tbody> </table>	Codice	Descrizione	Qtà	UM	0B1122A0	TRAVERSO INFERIORE PORTA 750 M	1	PZ	RC1200A0	MOLLA A COMPRESSIO NE DE4 DF0.5 H24	2	PZ	VI1220A1	VITE AUTOFIETTA NTE 4.2X11 TCS+ MARUTE	1	PZ	VI1996A0	VITE M5X35 TCEI ZN	7	PZ	VM1794A0	FASCETTA 250X4.8 PA66 NERA	2	PZ	VM2103A0	PIASTRINA FERMAFASCE TTA	2	PZ	VM2259A1	TAPPO INF SX PORTA S6	1	PZ	VM2261A1	TAPPO INF DX PORTA S6	1	PZ	VM2267A0	CORSOIO SISTEMA FERMA VETRO INT	1	PZ	VM2269A0	TAPPO SISTEMA FERMA VETRO INT	1	PZ	VM2274A0	BOCCOLA SCANALATA	1	PZ	VM2305A0	NOTTOLINO FISSAGGIO TAPPI PORTE MM	7	PZ	K0B1122AL	KIT TRAVERSO INF. PORTA CHEFTOP MM SX	<table border="1"> <thead> <tr> <th>Codice</th> <th>Descrizione</th> <th>Qtà</th> <th>UM</th> </tr> </thead> <tbody> <tr> <td>0B1122A0</td> <td>TRAVERSO INFERIORE PORTA 750 M</td> <td>1</td> <td>PZ</td> </tr> <tr> <td>RC1200A0</td> <td>MOLLA A COMPRESSIO NE DE4 DF0.5 H24</td> <td>2</td> <td>PZ</td> </tr> <tr> <td>VI1220A1</td> <td>VITE AUTOFIETTA NTE 4.2X11 TCS+ MARUTE</td> <td>1</td> <td>PZ</td> </tr> <tr> <td>VI1996A0</td> <td>VITE M5X35 TCEI ZN</td> <td>7</td> <td>PZ</td> </tr> <tr> <td>VM1794A0</td> <td>FASCETTA 250X4.8 PA66 NERA</td> <td>2</td> <td>PZ</td> </tr> </tbody> </table>	Codice	Descrizione	Qtà	UM	0B1122A0	TRAVERSO INFERIORE PORTA 750 M	1	PZ	RC1200A0	MOLLA A COMPRESSIO NE DE4 DF0.5 H24	2	PZ	VI1220A1	VITE AUTOFIETTA NTE 4.2X11 TCS+ MARUTE	1	PZ	VI1996A0	VITE M5X35 TCEI ZN	7	PZ	VM1794A0	FASCETTA 250X4.8 PA66 NERA	2	PZ
			Codice	Descrizione	Qtà	UM																																																																														
0B1122A0	TRAVERSO INFERIORE PORTA 750 M	1	PZ																																																																																	
RC1200A0	MOLLA A COMPRESSIO NE DE4 DF0.5 H24	2	PZ																																																																																	
VI1220A1	VITE AUTOFIETTA NTE 4.2X11 TCS+ MARUTE	1	PZ																																																																																	
VI1996A0	VITE M5X35 TCEI ZN	7	PZ																																																																																	
VM1794A0	FASCETTA 250X4.8 PA66 NERA	2	PZ																																																																																	
VM2103A0	PIASTRINA FERMAFASCE TTA	2	PZ																																																																																	
VM2259A1	TAPPO INF SX PORTA S6	1	PZ																																																																																	
VM2261A1	TAPPO INF DX PORTA S6	1	PZ																																																																																	
VM2267A0	CORSOIO SISTEMA FERMA VETRO INT	1	PZ																																																																																	
VM2269A0	TAPPO SISTEMA FERMA VETRO INT	1	PZ																																																																																	
VM2274A0	BOCCOLA SCANALATA	1	PZ																																																																																	
VM2305A0	NOTTOLINO FISSAGGIO TAPPI PORTE MM	7	PZ																																																																																	
Codice	Descrizione	Qtà	UM																																																																																	
0B1122A0	TRAVERSO INFERIORE PORTA 750 M	1	PZ																																																																																	
RC1200A0	MOLLA A COMPRESSIO NE DE4 DF0.5 H24	2	PZ																																																																																	
VI1220A1	VITE AUTOFIETTA NTE 4.2X11 TCS+ MARUTE	1	PZ																																																																																	
VI1996A0	VITE M5X35 TCEI ZN	7	PZ																																																																																	
VM1794A0	FASCETTA 250X4.8 PA66 NERA	2	PZ																																																																																	

COMPONENTE			RICAMBIO																																		
Codice	Descrizione	Immagine	Codice	Descrizione	Lista componenti																																
VM2261A	TAPPO INF DX PORTA S6		K0B1122AL	KIT TRAVERSO INF. PORTA CHEFTOP MM SX	<table border="1"> <thead> <tr> <th>Codice</th> <th>Descrizione</th> <th>Qtà</th> <th>UM</th> </tr> </thead> <tbody> <tr> <td>VM2103A0</td> <td>PIASTRINA FERMAFASCE TTA</td> <td>2</td> <td>PZ</td> </tr> <tr> <td>VM2267A0</td> <td>CORSOIO SISTEMA FERMA VETRO INT</td> <td>1</td> <td>PZ</td> </tr> <tr> <td>VM2269A0</td> <td>TAPPO SISTEMA FERMA VETRO INT</td> <td>1</td> <td>PZ</td> </tr> <tr> <td>VM2274A0</td> <td>BOCCOLA SCANALATA</td> <td>1</td> <td>PZ</td> </tr> <tr> <td>VM2305A0</td> <td>NOTTOLINO FISSAGGIO TAPPI PORTE MM</td> <td>7</td> <td>PZ</td> </tr> <tr> <td>VM2384A0</td> <td>TAPPO INF DX PORTA MM LEFT</td> <td>1</td> <td>PZ</td> </tr> <tr> <td>VM2386A1</td> <td>TAPPO INF SX PORTA MM LEFT</td> <td>1</td> <td>PZ</td> </tr> </tbody> </table>	Codice	Descrizione	Qtà	UM	VM2103A0	PIASTRINA FERMAFASCE TTA	2	PZ	VM2267A0	CORSOIO SISTEMA FERMA VETRO INT	1	PZ	VM2269A0	TAPPO SISTEMA FERMA VETRO INT	1	PZ	VM2274A0	BOCCOLA SCANALATA	1	PZ	VM2305A0	NOTTOLINO FISSAGGIO TAPPI PORTE MM	7	PZ	VM2384A0	TAPPO INF DX PORTA MM LEFT	1	PZ	VM2386A1	TAPPO INF SX PORTA MM LEFT	1	PZ
Codice	Descrizione	Qtà	UM																																		
VM2103A0	PIASTRINA FERMAFASCE TTA	2	PZ																																		
VM2267A0	CORSOIO SISTEMA FERMA VETRO INT	1	PZ																																		
VM2269A0	TAPPO SISTEMA FERMA VETRO INT	1	PZ																																		
VM2274A0	BOCCOLA SCANALATA	1	PZ																																		
VM2305A0	NOTTOLINO FISSAGGIO TAPPI PORTE MM	7	PZ																																		
VM2384A0	TAPPO INF DX PORTA MM LEFT	1	PZ																																		
VM2386A1	TAPPO INF SX PORTA MM LEFT	1	PZ																																		
VM2315A	SUPPORTO SPINGI VETRO INT MM		KVM2315A	KIT SUPPORTO SPINGI VETRO INT MM	<table border="1"> <thead> <tr> <th>Codice</th> <th>Descrizione</th> <th>Qtà</th> <th>UM</th> </tr> </thead> <tbody> <tr> <td>VI1220A1</td> <td>VITE AUTOFILETTA NTE 4.2X11 TCS+ MARUTE</td> <td>3</td> <td>PZ</td> </tr> <tr> <td>VM1630A0</td> <td>TAPPO PREMI VETRO INTERNO</td> <td>3</td> <td>PZ</td> </tr> <tr> <td>VM2315A0</td> <td>SUPPORTO SPINGI VETRO INT MM</td> <td>3</td> <td>PZ</td> </tr> </tbody> </table>	Codice	Descrizione	Qtà	UM	VI1220A1	VITE AUTOFILETTA NTE 4.2X11 TCS+ MARUTE	3	PZ	VM1630A0	TAPPO PREMI VETRO INTERNO	3	PZ	VM2315A0	SUPPORTO SPINGI VETRO INT MM	3	PZ																
Codice	Descrizione	Qtà	UM																																		
VI1220A1	VITE AUTOFILETTA NTE 4.2X11 TCS+ MARUTE	3	PZ																																		
VM1630A0	TAPPO PREMI VETRO INTERNO	3	PZ																																		
VM2315A0	SUPPORTO SPINGI VETRO INT MM	3	PZ																																		
VM1630A	TAPPO PREMI VETRO INTERNO		KVM2315A	KIT SUPPORTO SPINGI VETRO INT MM	<table border="1"> <thead> <tr> <th>Codice</th> <th>Descrizione</th> <th>Qtà</th> <th>UM</th> </tr> </thead> <tbody> <tr> <td>VI1220A1</td> <td>VITE AUTOFILETTA NTE 4.2X11 TCS+ MARUTE</td> <td>3</td> <td>PZ</td> </tr> <tr> <td>VM1630A0</td> <td>TAPPO PREMI VETRO INTERNO</td> <td>3</td> <td>PZ</td> </tr> <tr> <td>VM2315A0</td> <td>SUPPORTO SPINGI VETRO INT MM</td> <td>3</td> <td>PZ</td> </tr> </tbody> </table>	Codice	Descrizione	Qtà	UM	VI1220A1	VITE AUTOFILETTA NTE 4.2X11 TCS+ MARUTE	3	PZ	VM1630A0	TAPPO PREMI VETRO INTERNO	3	PZ	VM2315A0	SUPPORTO SPINGI VETRO INT MM	3	PZ																
Codice	Descrizione	Qtà	UM																																		
VI1220A1	VITE AUTOFILETTA NTE 4.2X11 TCS+ MARUTE	3	PZ																																		
VM1630A0	TAPPO PREMI VETRO INTERNO	3	PZ																																		
VM2315A0	SUPPORTO SPINGI VETRO INT MM	3	PZ																																		
			KVM1591A	KIT SPINGIVETRO INTERNO H35 S.5E	<table border="1"> <thead> <tr> <th>Codice</th> <th>Descrizione</th> <th>Qtà</th> <th>UM</th> </tr> </thead> <tbody> <tr> <td>VI1220A1</td> <td>VITE AUTOFILETTA NTE 4.2X11 TCS+ MARUTE</td> <td>2</td> <td>PZ</td> </tr> </tbody> </table>	Codice	Descrizione	Qtà	UM	VI1220A1	VITE AUTOFILETTA NTE 4.2X11 TCS+ MARUTE	2	PZ																								
Codice	Descrizione	Qtà	UM																																		
VI1220A1	VITE AUTOFILETTA NTE 4.2X11 TCS+ MARUTE	2	PZ																																		

COMPONENTE			RICAMBIO															
Codice	Descrizione	Immagine	Codice	Descrizione	Lista componenti													
VM1630A	TAPPO PREMI VETRO INTERNO		KVM1591A	KIT SPINGIVETRO INTERNO H35 S.5E	<table border="1"> <thead> <tr> <th>Codice</th> <th>Descrizione</th> <th>Qtà</th> <th>UM</th> </tr> </thead> <tbody> <tr> <td>VM1591A0</td> <td>STAFFA SPINGIVETRO INTERNO XVC1004</td> <td>1</td> <td>PZ</td> </tr> <tr> <td>VM1630A0</td> <td>TAPPO PREMI VETRO INTERNO</td> <td>2</td> <td>PZ</td> </tr> </tbody> </table>	Codice	Descrizione	Qtà	UM	VM1591A0	STAFFA SPINGIVETRO INTERNO XVC1004	1	PZ	VM1630A0	TAPPO PREMI VETRO INTERNO	2	PZ	
			Codice	Descrizione	Qtà	UM												
VM1591A0	STAFFA SPINGIVETRO INTERNO XVC1004	1	PZ															
VM1630A0	TAPPO PREMI VETRO INTERNO	2	PZ															
KVM1590A	KIT SPINGIVETRO INTERNO H25 S.5	<table border="1"> <thead> <tr> <th>Codice</th> <th>Descrizione</th> <th>Qtà</th> <th>UM</th> </tr> </thead> <tbody> <tr> <td>V11220A1</td> <td>VITE AUTOFILETTA NTE 4.2X11 TCS+ MARUTE</td> <td>2</td> <td>PZ</td> </tr> <tr> <td>VM1590A0</td> <td>STAFFA SPINGIVETRO INTERNO XVC705 XBC80</td> <td>1</td> <td>PZ</td> </tr> <tr> <td>VM1630A0</td> <td>TAPPO PREMI VETRO INTERNO</td> <td>2</td> <td>PZ</td> </tr> </tbody> </table>	Codice	Descrizione	Qtà	UM	V11220A1	VITE AUTOFILETTA NTE 4.2X11 TCS+ MARUTE	2	PZ	VM1590A0	STAFFA SPINGIVETRO INTERNO XVC705 XBC80	1	PZ	VM1630A0	TAPPO PREMI VETRO INTERNO	2	PZ
Codice	Descrizione	Qtà	UM															
V11220A1	VITE AUTOFILETTA NTE 4.2X11 TCS+ MARUTE	2	PZ															
VM1590A0	STAFFA SPINGIVETRO INTERNO XVC705 XBC80	1	PZ															
VM1630A0	TAPPO PREMI VETRO INTERNO	2	PZ															
VM2371A	SPINGIVETRO PORTE DOPPIO VETRO		KVM2371A	KIT SPINGI VETRO PORTE DOPPIO VETRO	<table border="1"> <thead> <tr> <th>Codice</th> <th>Descrizione</th> <th>Qtà</th> <th>UM</th> </tr> </thead> <tbody> <tr> <td>V11220A1</td> <td>VITE AUTOFILETTA NTE 4.2X11 TCS+ MARUTE</td> <td>3</td> <td>PZ</td> </tr> <tr> <td>VM2371A0</td> <td>SPINGIVETRO PORTE DOPPIO VETR</td> <td>3</td> <td>PZ</td> </tr> </tbody> </table>	Codice	Descrizione	Qtà	UM	V11220A1	VITE AUTOFILETTA NTE 4.2X11 TCS+ MARUTE	3	PZ	VM2371A0	SPINGIVETRO PORTE DOPPIO VETR	3	PZ	
Codice	Descrizione	Qtà	UM															
V11220A1	VITE AUTOFILETTA NTE 4.2X11 TCS+ MARUTE	3	PZ															
VM2371A0	SPINGIVETRO PORTE DOPPIO VETR	3	PZ															
VN1177A	VENTIL ASSIALE 40X40X10MM 12VCC		KVN1179A	KIT VENTIL ASSIALE 40X40X20MM 12VCC	<table border="1"> <thead> <tr> <th>Codice</th> <th>Descrizione</th> <th>Qtà</th> <th>UM</th> </tr> </thead> <tbody> <tr> <td>VN1179A0</td> <td>VENTIL ASSIALE 40X40X20MM 12VCC</td> <td>1</td> <td>PZ</td> </tr> </tbody> </table>	Codice	Descrizione	Qtà	UM	VN1179A0	VENTIL ASSIALE 40X40X20MM 12VCC	1	PZ					
			Codice	Descrizione	Qtà	UM												
VN1179A0	VENTIL ASSIALE 40X40X20MM 12VCC	1	PZ															
KVN1177A	KIT VENTIL ASSIALE 40X40X10MM 12VCC	<table border="1"> <thead> <tr> <th>Codice</th> <th>Descrizione</th> <th>Qtà</th> <th>UM</th> </tr> </thead> <tbody> <tr> <td>VN1177A0</td> <td>VENTIL ASSIALE 40X40X10MM 12VCC</td> <td>1</td> <td>PZ</td> </tr> </tbody> </table>	Codice	Descrizione	Qtà	UM	VN1177A0	VENTIL ASSIALE 40X40X10MM 12VCC	1	PZ								
Codice	Descrizione	Qtà	UM															
VN1177A0	VENTIL ASSIALE 40X40X10MM 12VCC	1	PZ															
VM2316A	SUPPORTO VENTOLA RAFF. CRUSCOTTO		KVM2518A	KIT SUPPORTO VENTOLA RAFF CRUS 20X20 H20	<table border="1"> <thead> <tr> <th>Codice</th> <th>Descrizione</th> <th>Qtà</th> <th>UM</th> </tr> </thead> <tbody> <tr> <td>VM2518A0</td> <td>SUPPORTO VENTOLA RAFF CRUS 20X20 H20</td> <td>1</td> <td>PZ</td> </tr> </tbody> </table>	Codice	Descrizione	Qtà	UM	VM2518A0	SUPPORTO VENTOLA RAFF CRUS 20X20 H20	1	PZ					
Codice	Descrizione	Qtà	UM															
VM2518A0	SUPPORTO VENTOLA RAFF CRUS 20X20 H20	1	PZ															

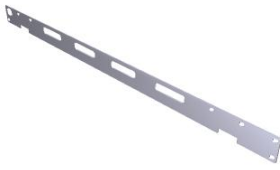

COMPONENTE			RICAMBIO																						
Codice	Descrizione	Immagine	Codice	Descrizione	Lista componenti																				
VM2316A	SUPPORTO VENTOLA RAFF. CRUSCOTTO		KVM2316A	KIT SUPPORTO VENTOLA RAFF. CRUSCOTTO	<table border="1"> <thead> <tr> <th>Codice</th> <th>Descrizione</th> <th>Qtà</th> <th>UM</th> </tr> </thead> <tbody> <tr> <td>VM2316A0</td> <td>SUPPORTO VENTOLA RAFF. CRUSCOTTO</td> <td>1</td> <td>PZ</td> </tr> </tbody> </table>	Codice	Descrizione	Qtà	UM	VM2316A0	SUPPORTO VENTOLA RAFF. CRUSCOTTO	1	PZ												
Codice	Descrizione	Qtà	UM																						
VM2316A0	SUPPORTO VENTOLA RAFF. CRUSCOTTO	1	PZ																						
0B1113A	COLONNINA ESTERNA DX PORTA XEVC-0711-E		0B1113A0	COLONNINA ESTERNA DX PORTA XEVC-0711-E																					
LP1020A	BARRA ILLUMINAZIONE LED MM L400 E583		KLP1020A	KIT RICAMBIO BARRA LED MM L400 E583	<table border="1"> <thead> <tr> <th>Codice</th> <th>Descrizione</th> <th>Qtà</th> <th>UM</th> </tr> </thead> <tbody> <tr> <td>IP1385A1</td> <td>IMB POL ANGOLARE 110X80X2000 D30</td> <td>1.240</td> <td>M</td> </tr> <tr> <td>LP1020A0</td> <td>BARRA ILLUMINAZION E LED MM L400 E583</td> <td>1</td> <td>PZ</td> </tr> <tr> <td>VM1058A1</td> <td>FILM TERMORETRA IBILE H410</td> <td>1.240</td> <td>M</td> </tr> <tr> <td>VM1059A1</td> <td>FILM TERMORETRA IBILE H800</td> <td>1.240</td> <td>M</td> </tr> </tbody> </table>	Codice	Descrizione	Qtà	UM	IP1385A1	IMB POL ANGOLARE 110X80X2000 D30	1.240	M	LP1020A0	BARRA ILLUMINAZION E LED MM L400 E583	1	PZ	VM1058A1	FILM TERMORETRA IBILE H410	1.240	M	VM1059A1	FILM TERMORETRA IBILE H800	1.240	M
Codice	Descrizione	Qtà	UM																						
IP1385A1	IMB POL ANGOLARE 110X80X2000 D30	1.240	M																						
LP1020A0	BARRA ILLUMINAZION E LED MM L400 E583	1	PZ																						
VM1058A1	FILM TERMORETRA IBILE H410	1.240	M																						
VM1059A1	FILM TERMORETRA IBILE H800	1.240	M																						
LP1026A	ESTRUSO ILLUMINAZIONE NO LED MM L583		KLP1026A	KIT ESTRUSO ILLUMINAZIONE NO LED MM L583	<table border="1"> <thead> <tr> <th>Codice</th> <th>Descrizione</th> <th>Qtà</th> <th>UM</th> </tr> </thead> <tbody> <tr> <td>IP1385A1</td> <td>IMB POL ANGOLARE 110X80X2000 D30</td> <td>1.240</td> <td>M</td> </tr> <tr> <td>LP1026A0</td> <td>ESTRUSO ILLUMINAZION E NO LED MM L583</td> <td>1</td> <td>PZ</td> </tr> <tr> <td>VM1058A1</td> <td>FILM TERMORETRA IBILE H410</td> <td>1.240</td> <td>M</td> </tr> <tr> <td>VM1059A1</td> <td>FILM TERMORETRA IBILE H800</td> <td>1.240</td> <td>M</td> </tr> </tbody> </table>	Codice	Descrizione	Qtà	UM	IP1385A1	IMB POL ANGOLARE 110X80X2000 D30	1.240	M	LP1026A0	ESTRUSO ILLUMINAZION E NO LED MM L583	1	PZ	VM1058A1	FILM TERMORETRA IBILE H410	1.240	M	VM1059A1	FILM TERMORETRA IBILE H800	1.240	M
Codice	Descrizione	Qtà	UM																						
IP1385A1	IMB POL ANGOLARE 110X80X2000 D30	1.240	M																						
LP1026A0	ESTRUSO ILLUMINAZION E NO LED MM L583	1	PZ																						
VM1058A1	FILM TERMORETRA IBILE H410	1.240	M																						
VM1059A1	FILM TERMORETRA IBILE H800	1.240	M																						

COMPONENTE			RICAMBIO																																																						
Codice	Descrizione	Immagine	Codice	Descrizione	Lista componenti																																																				
0B1126A	TRAVERSO INFERIORE PORTA 860 MM		K0B1126AR	KIT TRAVERSO INF. PORTA BAKERTOP DX	<table border="1"> <thead> <tr> <th>Codice</th> <th>Descrizione</th> <th>Qtà</th> <th>UM</th> </tr> </thead> <tbody> <tr> <td>0B1126A0</td> <td>TRAVERSO INFERIORE PORTA 860 M</td> <td>1</td> <td>PZ</td> </tr> <tr> <td>RC1200A0</td> <td>MOLLA A COMPRESSIO NE DE4 DF0.5 H24</td> <td>2</td> <td>PZ</td> </tr> <tr> <td>VI1220A1</td> <td>VITE AUTOFIETTA NTE 4.2X11 TCS+ MARUTE</td> <td>1</td> <td>PZ</td> </tr> <tr> <td>VI1996A0</td> <td>VITE M5X35 TCEI ZN</td> <td>7</td> <td>PZ</td> </tr> <tr> <td>VM1794A0</td> <td>FASCETTA 250X4.8 PA66 NERA</td> <td>2</td> <td>PZ</td> </tr> <tr> <td>VM2103A0</td> <td>PIASTRINA FERMAFASCE TTA</td> <td>2</td> <td>PZ</td> </tr> <tr> <td>VM2259A1</td> <td>TAPPO INF SX PORTA S6</td> <td>1</td> <td>PZ</td> </tr> <tr> <td>VM2261A1</td> <td>TAPPO INF DX PORTA S6</td> <td>1</td> <td>PZ</td> </tr> <tr> <td>VM2267A0</td> <td>CORSOIO SISTEMA FERMA VETRO INT</td> <td>1</td> <td>PZ</td> </tr> <tr> <td>VM2269A0</td> <td>TAPPO SISTEMA FERMA VETRO INT</td> <td>1</td> <td>PZ</td> </tr> <tr> <td>VM2274A0</td> <td>BOCCOLA SCANALATA</td> <td>1</td> <td>PZ</td> </tr> <tr> <td>VM2305A0</td> <td>NOTTOLINO FISSAGGIO TAPPI PORTE MM</td> <td>7</td> <td>PZ</td> </tr> </tbody> </table>	Codice	Descrizione	Qtà	UM	0B1126A0	TRAVERSO INFERIORE PORTA 860 M	1	PZ	RC1200A0	MOLLA A COMPRESSIO NE DE4 DF0.5 H24	2	PZ	VI1220A1	VITE AUTOFIETTA NTE 4.2X11 TCS+ MARUTE	1	PZ	VI1996A0	VITE M5X35 TCEI ZN	7	PZ	VM1794A0	FASCETTA 250X4.8 PA66 NERA	2	PZ	VM2103A0	PIASTRINA FERMAFASCE TTA	2	PZ	VM2259A1	TAPPO INF SX PORTA S6	1	PZ	VM2261A1	TAPPO INF DX PORTA S6	1	PZ	VM2267A0	CORSOIO SISTEMA FERMA VETRO INT	1	PZ	VM2269A0	TAPPO SISTEMA FERMA VETRO INT	1	PZ	VM2274A0	BOCCOLA SCANALATA	1	PZ	VM2305A0	NOTTOLINO FISSAGGIO TAPPI PORTE MM	7	PZ
			Codice	Descrizione	Qtà	UM																																																			
0B1126A0	TRAVERSO INFERIORE PORTA 860 M	1	PZ																																																						
RC1200A0	MOLLA A COMPRESSIO NE DE4 DF0.5 H24	2	PZ																																																						
VI1220A1	VITE AUTOFIETTA NTE 4.2X11 TCS+ MARUTE	1	PZ																																																						
VI1996A0	VITE M5X35 TCEI ZN	7	PZ																																																						
VM1794A0	FASCETTA 250X4.8 PA66 NERA	2	PZ																																																						
VM2103A0	PIASTRINA FERMAFASCE TTA	2	PZ																																																						
VM2259A1	TAPPO INF SX PORTA S6	1	PZ																																																						
VM2261A1	TAPPO INF DX PORTA S6	1	PZ																																																						
VM2267A0	CORSOIO SISTEMA FERMA VETRO INT	1	PZ																																																						
VM2269A0	TAPPO SISTEMA FERMA VETRO INT	1	PZ																																																						
VM2274A0	BOCCOLA SCANALATA	1	PZ																																																						
VM2305A0	NOTTOLINO FISSAGGIO TAPPI PORTE MM	7	PZ																																																						
K0B1126AL	KIT TRAVERSO INF PORTA BAKERTOP SX	<table border="1"> <thead> <tr> <th>Codice</th> <th>Descrizione</th> <th>Qtà</th> <th>UM</th> </tr> </thead> <tbody> <tr> <td>0B1126A0</td> <td>TRAVERSO INFERIORE PORTA 860 M</td> <td>1</td> <td>PZ</td> </tr> <tr> <td>RC1200A0</td> <td>MOLLA A COMPRESSIO NE DE4 DF0.5 H24</td> <td>2</td> <td>PZ</td> </tr> <tr> <td>VI1220A1</td> <td>VITE AUTOFIETTA NTE 4.2X11 TCS+ MARUTE</td> <td>1</td> <td>PZ</td> </tr> <tr> <td>VI1996A0</td> <td>VITE M5X35 TCEI ZN</td> <td>7</td> <td>PZ</td> </tr> <tr> <td>VM1794A0</td> <td>FASCETTA 250X4.8 PA66 NERA</td> <td>2</td> <td>PZ</td> </tr> </tbody> </table>	Codice	Descrizione	Qtà	UM	0B1126A0	TRAVERSO INFERIORE PORTA 860 M	1	PZ	RC1200A0	MOLLA A COMPRESSIO NE DE4 DF0.5 H24	2	PZ	VI1220A1	VITE AUTOFIETTA NTE 4.2X11 TCS+ MARUTE	1	PZ	VI1996A0	VITE M5X35 TCEI ZN	7	PZ	VM1794A0	FASCETTA 250X4.8 PA66 NERA	2	PZ																															
Codice	Descrizione	Qtà	UM																																																						
0B1126A0	TRAVERSO INFERIORE PORTA 860 M	1	PZ																																																						
RC1200A0	MOLLA A COMPRESSIO NE DE4 DF0.5 H24	2	PZ																																																						
VI1220A1	VITE AUTOFIETTA NTE 4.2X11 TCS+ MARUTE	1	PZ																																																						
VI1996A0	VITE M5X35 TCEI ZN	7	PZ																																																						
VM1794A0	FASCETTA 250X4.8 PA66 NERA	2	PZ																																																						



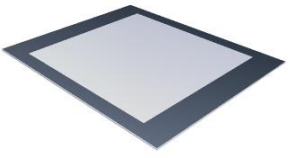
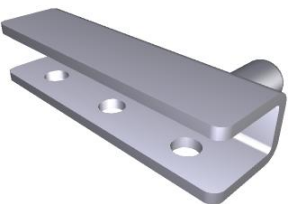

COMPONENTE			RICAMBIO																																		
Codice	Descrizione	Immagine	Codice	Descrizione	Lista componenti																																
OB1126A	TRAVERSO INFERIORE PORTA 860 MM		K0B1126AL	KIT TRAVERSO INF PORTA BAKERTOP SX	<table border="1"> <thead> <tr> <th>Codice</th> <th>Descrizione</th> <th>Qtà</th> <th>UM</th> </tr> </thead> <tbody> <tr> <td>VM2103A0</td> <td>PIASTRINA FERMAFASCE TTA</td> <td>2</td> <td>PZ</td> </tr> <tr> <td>VM2267A0</td> <td>CORSOIO SISTEMA FERMA VETRO INT</td> <td>1</td> <td>PZ</td> </tr> <tr> <td>VM2269A0</td> <td>TAPPO SISTEMA FERMA VETRO INT</td> <td>1</td> <td>PZ</td> </tr> <tr> <td>VM2274A0</td> <td>BOCCOLA SCANALATA</td> <td>1</td> <td>PZ</td> </tr> <tr> <td>VM2305A0</td> <td>NOTTOLINO FISSAGGIO TAPPI PORTE MM</td> <td>7</td> <td>PZ</td> </tr> <tr> <td>VM2384A0</td> <td>TAPPO INF DX PORTA MM LEFT</td> <td>1</td> <td>PZ</td> </tr> <tr> <td>VM2386A1</td> <td>TAPPO INF SX PORTA MM LEFT</td> <td>1</td> <td>PZ</td> </tr> </tbody> </table>	Codice	Descrizione	Qtà	UM	VM2103A0	PIASTRINA FERMAFASCE TTA	2	PZ	VM2267A0	CORSOIO SISTEMA FERMA VETRO INT	1	PZ	VM2269A0	TAPPO SISTEMA FERMA VETRO INT	1	PZ	VM2274A0	BOCCOLA SCANALATA	1	PZ	VM2305A0	NOTTOLINO FISSAGGIO TAPPI PORTE MM	7	PZ	VM2384A0	TAPPO INF DX PORTA MM LEFT	1	PZ	VM2386A1	TAPPO INF SX PORTA MM LEFT	1	PZ
Codice	Descrizione	Qtà	UM																																		
VM2103A0	PIASTRINA FERMAFASCE TTA	2	PZ																																		
VM2267A0	CORSOIO SISTEMA FERMA VETRO INT	1	PZ																																		
VM2269A0	TAPPO SISTEMA FERMA VETRO INT	1	PZ																																		
VM2274A0	BOCCOLA SCANALATA	1	PZ																																		
VM2305A0	NOTTOLINO FISSAGGIO TAPPI PORTE MM	7	PZ																																		
VM2384A0	TAPPO INF DX PORTA MM LEFT	1	PZ																																		
VM2386A1	TAPPO INF SX PORTA MM LEFT	1	PZ																																		
VM2312A	TUBETTO SX SCARICO GOCCIOLATOIO MM		KVM2312A	KIT TUBETTO SX SCARICO GOCCIOLATOIO MM	<table border="1"> <thead> <tr> <th>Codice</th> <th>Descrizione</th> <th>Qtà</th> <th>UM</th> </tr> </thead> <tbody> <tr> <td>VM2312A0</td> <td>TUBETTO SX SCARICO GOCCIOLATOIO O MM</td> <td>1</td> <td>PZ</td> </tr> </tbody> </table>	Codice	Descrizione	Qtà	UM	VM2312A0	TUBETTO SX SCARICO GOCCIOLATOIO O MM	1	PZ																								
Codice	Descrizione	Qtà	UM																																		
VM2312A0	TUBETTO SX SCARICO GOCCIOLATOIO O MM	1	PZ																																		
VM2314A	TAPPINO GOCCIOLATOIO MM		KVM2314A	KIT TAPPINO GOCCIOLATOIO MIND.MAPS	<table border="1"> <thead> <tr> <th>Codice</th> <th>Descrizione</th> <th>Qtà</th> <th>UM</th> </tr> </thead> <tbody> <tr> <td>VM2314A0</td> <td>TAPPINO GOCCIOLATOIO O MM</td> <td>1</td> <td>PZ</td> </tr> </tbody> </table>	Codice	Descrizione	Qtà	UM	VM2314A0	TAPPINO GOCCIOLATOIO O MM	1	PZ																								
Codice	Descrizione	Qtà	UM																																		
VM2314A0	TAPPINO GOCCIOLATOIO O MM	1	PZ																																		
VM2285A	PROFILO SALVAGOCCE SERIE 860		KVM2285A	KIT PROFILO SALVAGOCCE SERIE 860	<table border="1"> <thead> <tr> <th>Codice</th> <th>Descrizione</th> <th>Qtà</th> <th>UM</th> </tr> </thead> <tbody> <tr> <td>VM2285A0</td> <td>PROFILO SALVAGOCCE SERIE 860</td> <td>1</td> <td>PZ</td> </tr> </tbody> </table>	Codice	Descrizione	Qtà	UM	VM2285A0	PROFILO SALVAGOCCE SERIE 860	1	PZ																								
Codice	Descrizione	Qtà	UM																																		
VM2285A0	PROFILO SALVAGOCCE SERIE 860	1	PZ																																		

COMPONENTE			RICAMBIO																																		
Codice	Descrizione	Immagine	Codice	Descrizione	Lista componenti																																
VM2313A	TUBETTO DX SCARICO GOCCIOLATOIO MM		KVM2313A	KIT TUBETTO DX SCARICO GOCCIOLATOIO S6	<table border="1"> <thead> <tr> <th>Codice</th> <th>Descrizione</th> <th>Qtà</th> <th>UM</th> </tr> </thead> <tbody> <tr> <td>VM2313A0</td> <td>TUBETTO DX SCARICO GOCCIOLATOIO O MM</td> <td>1</td> <td>PZ</td> </tr> </tbody> </table>	Codice	Descrizione	Qtà	UM	VM2313A0	TUBETTO DX SCARICO GOCCIOLATOIO O MM	1	PZ																								
Codice	Descrizione	Qtà	UM																																		
VM2313A0	TUBETTO DX SCARICO GOCCIOLATOIO O MM	1	PZ																																		
VT1291A	VETRO EST. SER. XEBC-06EU-E		KVT1291A	KIT VETRO ESTERNO 06EU	<table border="1"> <thead> <tr> <th>Codice</th> <th>Descrizione</th> <th>Qtà</th> <th>UM</th> </tr> </thead> <tbody> <tr> <td>0B1167A0</td> <td>PROFILO SUPPORTO VETRO EST XEVC-0711-E</td> <td>2</td> <td>PZ</td> </tr> <tr> <td>IP1508A0</td> <td>POLISTIROLO PROFILO AD U 2000X60X60</td> <td>1</td> <td>PZ</td> </tr> <tr> <td>IP1508A1</td> <td>POLISTIROLO PROFILO AD U 2000X60X60</td> <td>1</td> <td>M</td> </tr> <tr> <td>SL1155A1</td> <td>SILICONE BICOMPONEN TE LOCTITE</td> <td>150</td> <td>ML</td> </tr> <tr> <td>SL1156A0</td> <td>PUNTALE PER PISTOLA SILICONE BICOMPONEN</td> <td>1</td> <td>PZ</td> </tr> <tr> <td>VM1059A1</td> <td>FILM TERMORETRA IBILE H800</td> <td>1.500</td> <td>M</td> </tr> <tr> <td>VT1291A0</td> <td>VETRO EST. SER. XEBC-06EU-E</td> <td>1</td> <td>PZ</td> </tr> </tbody> </table>	Codice	Descrizione	Qtà	UM	0B1167A0	PROFILO SUPPORTO VETRO EST XEVC-0711-E	2	PZ	IP1508A0	POLISTIROLO PROFILO AD U 2000X60X60	1	PZ	IP1508A1	POLISTIROLO PROFILO AD U 2000X60X60	1	M	SL1155A1	SILICONE BICOMPONEN TE LOCTITE	150	ML	SL1156A0	PUNTALE PER PISTOLA SILICONE BICOMPONEN	1	PZ	VM1059A1	FILM TERMORETRA IBILE H800	1.500	M	VT1291A0	VETRO EST. SER. XEBC-06EU-E	1	PZ
Codice	Descrizione	Qtà	UM																																		
0B1167A0	PROFILO SUPPORTO VETRO EST XEVC-0711-E	2	PZ																																		
IP1508A0	POLISTIROLO PROFILO AD U 2000X60X60	1	PZ																																		
IP1508A1	POLISTIROLO PROFILO AD U 2000X60X60	1	M																																		
SL1155A1	SILICONE BICOMPONEN TE LOCTITE	150	ML																																		
SL1156A0	PUNTALE PER PISTOLA SILICONE BICOMPONEN	1	PZ																																		
VM1059A1	FILM TERMORETRA IBILE H800	1.500	M																																		
VT1291A0	VETRO EST. SER. XEBC-06EU-E	1	PZ																																		
VI1034A	RONDELLA PIANA 8.4X16X1 INOX		VI1034A0	RONDELLA PIANA 8.4X16X1 INOX																																	
0B1218A	TRAVERSO SUPERIORE PORTA 860 MM 2V		0B1218A0	TRAVERSO SUPERIORE PORTA 860 MM 2V																																	

COMPONENTE			RICAMBIO														
Codice	Descrizione	Immagine	Codice	Descrizione	Lista componenti												
VM2410A	PIASTRINA FERMA ESTRUSO BARRA LED		KVM2410A	KIT PIASTRINA FERMA ESTRUSO BARRA LED 2P	<table border="1"> <thead> <tr> <th>Codice</th> <th>Descrizione</th> <th>Qtà</th> <th>UM</th> </tr> </thead> <tbody> <tr> <td>0B1190A0</td> <td>PIASTRINA FERMA ESTRUSO BARRA LED</td> <td>2</td> <td>PZ</td> </tr> <tr> <td>VM2410A0</td> <td>PIASTRINA FERMA ESTRUSO BARRA LED</td> <td>2</td> <td>PZ</td> </tr> </tbody> </table>	Codice	Descrizione	Qtà	UM	0B1190A0	PIASTRINA FERMA ESTRUSO BARRA LED	2	PZ	VM2410A0	PIASTRINA FERMA ESTRUSO BARRA LED	2	PZ
Codice	Descrizione	Qtà	UM														
0B1190A0	PIASTRINA FERMA ESTRUSO BARRA LED	2	PZ														
VM2410A0	PIASTRINA FERMA ESTRUSO BARRA LED	2	PZ														
VM2305A	NOTTOLINO FISSAGGIO TAPPI PORTE MM		VM2305A0	NOTTOLINO FISSAGGIO TAPPI PORTE MM													
VM2275A	BOCCOLA LISCIA		KVM2275A	KIT BOCCOLA LISCIA VM2275A0	<table border="1"> <thead> <tr> <th>Codice</th> <th>Descrizione</th> <th>Qtà</th> <th>UM</th> </tr> </thead> <tbody> <tr> <td>VM2275A0</td> <td>BOCCOLA LISCIA</td> <td>1</td> <td>PZ</td> </tr> </tbody> </table>	Codice	Descrizione	Qtà	UM	VM2275A0	BOCCOLA LISCIA	1	PZ				
Codice	Descrizione	Qtà	UM														
VM2275A0	BOCCOLA LISCIA	1	PZ														
VI1996A	VITE M5X35 TCEI ZN		VI1996A0	VITE M5X35 TCEI ZN													
VM2260A	TAPPO SUP SX PORTA S6		KVM2260A	KIT TAPPO SUP SX PORTA MIND MAPS	<table border="1"> <thead> <tr> <th>Codice</th> <th>Descrizione</th> <th>Qtà</th> <th>UM</th> </tr> </thead> <tbody> <tr> <td>VM2260A1</td> <td>TAPPO SUP SX PORTA S6</td> <td>1</td> <td>PZ</td> </tr> </tbody> </table>	Codice	Descrizione	Qtà	UM	VM2260A1	TAPPO SUP SX PORTA S6	1	PZ				
Codice	Descrizione	Qtà	UM														
VM2260A1	TAPPO SUP SX PORTA S6	1	PZ														

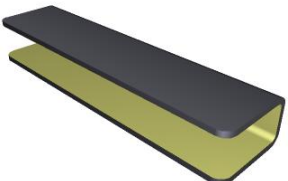
COMPONENTE			RICAMBIO																						
Codice	Descrizione	Immagine	Codice	Descrizione	Lista componenti																				
0B1175A	COLONNINA ESTERNA SX PORTA XEBC-06EU-		0B1175A0	COLONNINA ESTERNA SX PORTA XEBC-06EU-																					
0B1114A	COLONNINA INTERNA DX PORTA 0711 RIGHT																								
VT1294A	VETRO INT. SER. XEBC-06EU-E		KVT1294A	KIT VETRO INTERNO SINGOLO 06EU	<table border="1"> <thead> <tr> <th>Codice</th> <th>Descrizione</th> <th>Qta</th> <th>UM</th> </tr> </thead> <tbody> <tr> <td>IP1508A0</td> <td>POLISTIROLO PROFILO AD U 2000X60X60</td> <td>1</td> <td>PZ</td> </tr> <tr> <td>IP1508A1</td> <td>POLISTIROLO PROFILO AD U 2000X60X60</td> <td>1</td> <td>M</td> </tr> <tr> <td>VM1059A1</td> <td>FILM TERMORETRA IBILE H800</td> <td>1.500</td> <td>M</td> </tr> <tr> <td>VT1294A0</td> <td>VETRO INT. SER. XEBC-06EU-E</td> <td>1</td> <td>PZ</td> </tr> </tbody> </table>	Codice	Descrizione	Qta	UM	IP1508A0	POLISTIROLO PROFILO AD U 2000X60X60	1	PZ	IP1508A1	POLISTIROLO PROFILO AD U 2000X60X60	1	M	VM1059A1	FILM TERMORETRA IBILE H800	1.500	M	VT1294A0	VETRO INT. SER. XEBC-06EU-E	1	PZ
Codice	Descrizione	Qta	UM																						
IP1508A0	POLISTIROLO PROFILO AD U 2000X60X60	1	PZ																						
IP1508A1	POLISTIROLO PROFILO AD U 2000X60X60	1	M																						
VM1059A1	FILM TERMORETRA IBILE H800	1.500	M																						
VT1294A0	VETRO INT. SER. XEBC-06EU-E	1	PZ																						
CR1103A	CERNIERA VETRO INTERNO INOX SUP		KCR1103A	KIT CERNIERA VETRO INTERNO INOX SUP	<table border="1"> <thead> <tr> <th>Codice</th> <th>Descrizione</th> <th>Qta</th> <th>UM</th> </tr> </thead> <tbody> <tr> <td>CR1103A0</td> <td>CERNIERA VETRO INTERNO INOX SUP</td> <td>1</td> <td>PZ</td> </tr> <tr> <td>GN1182A0</td> <td>GUARNIZIONE CERN VETRO INT CR1103-1104</td> <td>1</td> <td>PZ</td> </tr> <tr> <td>GN1182A1</td> <td>GUARNIZIONE CERN VETRO INT CR1103-1104</td> <td>1</td> <td>PZ</td> </tr> <tr> <td>VI1810A0</td> <td>VITE NO TESTA EI M6X6 TESTA PIANA INOX</td> <td>3</td> <td>PZ</td> </tr> </tbody> </table>	Codice	Descrizione	Qta	UM	CR1103A0	CERNIERA VETRO INTERNO INOX SUP	1	PZ	GN1182A0	GUARNIZIONE CERN VETRO INT CR1103-1104	1	PZ	GN1182A1	GUARNIZIONE CERN VETRO INT CR1103-1104	1	PZ	VI1810A0	VITE NO TESTA EI M6X6 TESTA PIANA INOX	3	PZ
Codice	Descrizione	Qta	UM																						
CR1103A0	CERNIERA VETRO INTERNO INOX SUP	1	PZ																						
GN1182A0	GUARNIZIONE CERN VETRO INT CR1103-1104	1	PZ																						
GN1182A1	GUARNIZIONE CERN VETRO INT CR1103-1104	1	PZ																						
VI1810A0	VITE NO TESTA EI M6X6 TESTA PIANA INOX	3	PZ																						

COMPONENTE			RICAMBIO																						
Codice	Descrizione	Immagine	Codice	Descrizione	Lista componenti																				
VM2399A	COVER VITI SENZA TESTA CERNIERE PORTA		VM2399A0	COVER VITI SENZA TESTA CERNIERE PORTA																					
GN1182A	GUARNIZIONE CERN VETRO INT CR1103-1104		KGN1182A	KIT 2 GUARN.CERNIERE VETRO INT CR1103-	<table border="1"> <thead> <tr> <th>Codice</th> <th>Descrizione</th> <th>Qtà</th> <th>UM</th> </tr> </thead> <tbody> <tr> <td>GN1182A0</td> <td>GUARNIZIONE CERN VETRO INT CR1103-1104</td> <td>2</td> <td>PZ</td> </tr> <tr> <td>GN1182A1</td> <td>GUARNIZIONE CERN VETRO INT CR1103-1104</td> <td>2</td> <td>PZ</td> </tr> </tbody> </table>	Codice	Descrizione	Qtà	UM	GN1182A0	GUARNIZIONE CERN VETRO INT CR1103-1104	2	PZ	GN1182A1	GUARNIZIONE CERN VETRO INT CR1103-1104	2	PZ								
Codice	Descrizione	Qtà	UM																						
GN1182A0	GUARNIZIONE CERN VETRO INT CR1103-1104	2	PZ																						
GN1182A1	GUARNIZIONE CERN VETRO INT CR1103-1104	2	PZ																						
CR1104A	CERNIERA VETRO INTERNO INOX INF		KCR1104A	KIT CERNIERA VETRO INTERNO INOX INF	<table border="1"> <thead> <tr> <th>Codice</th> <th>Descrizione</th> <th>Qtà</th> <th>UM</th> </tr> </thead> <tbody> <tr> <td>CR1104A0</td> <td>CERNIERA VETRO INTERNO INOX INF</td> <td>1</td> <td>PZ</td> </tr> <tr> <td>GN1182A0</td> <td>GUARNIZIONE CERN VETRO INT CR1103-1104</td> <td>1</td> <td>PZ</td> </tr> <tr> <td>GN1182A1</td> <td>GUARNIZIONE CERN VETRO INT CR1103-1104</td> <td>1</td> <td>PZ</td> </tr> <tr> <td>VI1810A0</td> <td>VITE NO TESTA EI M6X6 TESTA PIANA INOX</td> <td>3</td> <td>PZ</td> </tr> </tbody> </table>	Codice	Descrizione	Qtà	UM	CR1104A0	CERNIERA VETRO INTERNO INOX INF	1	PZ	GN1182A0	GUARNIZIONE CERN VETRO INT CR1103-1104	1	PZ	GN1182A1	GUARNIZIONE CERN VETRO INT CR1103-1104	1	PZ	VI1810A0	VITE NO TESTA EI M6X6 TESTA PIANA INOX	3	PZ
Codice	Descrizione	Qtà	UM																						
CR1104A0	CERNIERA VETRO INTERNO INOX INF	1	PZ																						
GN1182A0	GUARNIZIONE CERN VETRO INT CR1103-1104	1	PZ																						
GN1182A1	GUARNIZIONE CERN VETRO INT CR1103-1104	1	PZ																						
VI1810A0	VITE NO TESTA EI M6X6 TESTA PIANA INOX	3	PZ																						
VM2399A	COVER VITI SENZA TESTA CERNIERE PORTA		VM2399A0	COVER VITI SENZA TESTA CERNIERE PORTA																					

COMPONENTE			RICAMBIO																						
Codice	Descrizione	Immagine	Codice	Descrizione	Lista componenti																				
GN1182A	GUARNIZIONE CERN VETRO INT CR1103-1104		KGN1182A	KIT 2 GUARN.CERNIERE VETRO INT CR1103-	<table border="1"> <thead> <tr> <th>Codice</th> <th>Descrizione</th> <th>Qtà</th> <th>UM</th> </tr> </thead> <tbody> <tr> <td>GN1182A0</td> <td>GUARNIZIONE CERN VETRO INT CR1103-1104</td> <td>2</td> <td>PZ</td> </tr> <tr> <td>GN1182A1</td> <td>GUARNIZIONE CERN VETRO INT CR1103-1104</td> <td>2</td> <td>PZ</td> </tr> </tbody> </table>	Codice	Descrizione	Qtà	UM	GN1182A0	GUARNIZIONE CERN VETRO INT CR1103-1104	2	PZ	GN1182A1	GUARNIZIONE CERN VETRO INT CR1103-1104	2	PZ								
Codice	Descrizione	Qtà	UM																						
GN1182A0	GUARNIZIONE CERN VETRO INT CR1103-1104	2	PZ																						
GN1182A1	GUARNIZIONE CERN VETRO INT CR1103-1104	2	PZ																						
0B1112A	COLONNINA INTERNA SX PORTA 0711 RIGHT																								
0B1219A	TRAVERSO SUPERIORE INT PORTA 860 S6 2V		0B1219A1	TRAVERSO SUPERIORE INT PORTA 860 S6 2V																					
PE2046A	ASSIEME SUPPORTO USB-RESET MM		KPE2046A	KIT ASSIEME SUPPORTO USB-RESET MM	<table border="1"> <thead> <tr> <th>Codice</th> <th>Descrizione</th> <th>Qtà</th> <th>UM</th> </tr> </thead> <tbody> <tr> <td>PE2046A0</td> <td>ASSIEME SUPPORTO USB-RESET M</td> <td>1</td> <td>PZ</td> </tr> <tr> <td>PE2046A1</td> <td>ASSIEME SUPPORTO USB-RESET M</td> <td>1</td> <td>PZ</td> </tr> <tr> <td>VI1220A1</td> <td>VITE AUTOFILETTA NTE 4.2X11 TCS+ MARUTE</td> <td>2</td> <td>PZ</td> </tr> <tr> <td>VM2147A0</td> <td>SPUGNA ESD ROSA LISCIA 410X343X15 M</td> <td>0.250</td> <td>PZ</td> </tr> </tbody> </table>	Codice	Descrizione	Qtà	UM	PE2046A0	ASSIEME SUPPORTO USB-RESET M	1	PZ	PE2046A1	ASSIEME SUPPORTO USB-RESET M	1	PZ	VI1220A1	VITE AUTOFILETTA NTE 4.2X11 TCS+ MARUTE	2	PZ	VM2147A0	SPUGNA ESD ROSA LISCIA 410X343X15 M	0.250	PZ
Codice	Descrizione	Qtà	UM																						
PE2046A0	ASSIEME SUPPORTO USB-RESET M	1	PZ																						
PE2046A1	ASSIEME SUPPORTO USB-RESET M	1	PZ																						
VI1220A1	VITE AUTOFILETTA NTE 4.2X11 TCS+ MARUTE	2	PZ																						
VM2147A0	SPUGNA ESD ROSA LISCIA 410X343X15 M	0.250	PZ																						
PE2042A	ASSIEME CRUSCOTTO COMANDI MM ONE		KPE2042A	KIT CONTROLLO COMANDI MIND.MAPS ONE	<table border="1"> <thead> <tr> <th>Codice</th> <th>Descrizione</th> <th>Qtà</th> <th>UM</th> </tr> </thead> <tbody> <tr> <td>PE2042A0</td> <td>ASSIEME CRUSCOTTO COMANDI MM ONE</td> <td>1</td> <td>PZ</td> </tr> <tr> <td>PE2042A1</td> <td>ASSIEME CRUSCOTTO COMANDI MM ONE</td> <td>1</td> <td>PZ</td> </tr> </tbody> </table>	Codice	Descrizione	Qtà	UM	PE2042A0	ASSIEME CRUSCOTTO COMANDI MM ONE	1	PZ	PE2042A1	ASSIEME CRUSCOTTO COMANDI MM ONE	1	PZ								
Codice	Descrizione	Qtà	UM																						
PE2042A0	ASSIEME CRUSCOTTO COMANDI MM ONE	1	PZ																						
PE2042A1	ASSIEME CRUSCOTTO COMANDI MM ONE	1	PZ																						

COMPONENTE			RICAMBIO																		
Codice	Descrizione	Immagine	Codice	Descrizione	Lista componenti																
PE2042A	ASSIEME CRUSCOTTO COMANDI MM ONE		KPE2042A	KIT CONTROLLO COMANDI MIND.MAPS ONE	<table border="1"> <thead> <tr> <th>Codice</th> <th>Descrizione</th> <th>Qtà</th> <th>UM</th> </tr> </thead> <tbody> <tr> <td>PE2042A2</td> <td>ASSIEME CRUSCOTTO COMANDI MM ONE</td> <td>1</td> <td>PZ</td> </tr> <tr> <td>VI2000A0</td> <td>VITE M4X22 TCB+ INOX</td> <td>4</td> <td>PZ</td> </tr> <tr> <td>VM2147A0</td> <td>SPUGNA ESD ROSA LISCIA 410X343X15 M</td> <td>1</td> <td>PZ</td> </tr> </tbody> </table>	Codice	Descrizione	Qtà	UM	PE2042A2	ASSIEME CRUSCOTTO COMANDI MM ONE	1	PZ	VI2000A0	VITE M4X22 TCB+ INOX	4	PZ	VM2147A0	SPUGNA ESD ROSA LISCIA 410X343X15 M	1	PZ
Codice	Descrizione	Qtà	UM																		
PE2042A2	ASSIEME CRUSCOTTO COMANDI MM ONE	1	PZ																		
VI2000A0	VITE M4X22 TCB+ INOX	4	PZ																		
VM2147A0	SPUGNA ESD ROSA LISCIA 410X343X15 M	1	PZ																		

ASM1745A/0.D03 - Camera di cottura

FRONTE





ASM1745A/0.D03 - Camera di cottura

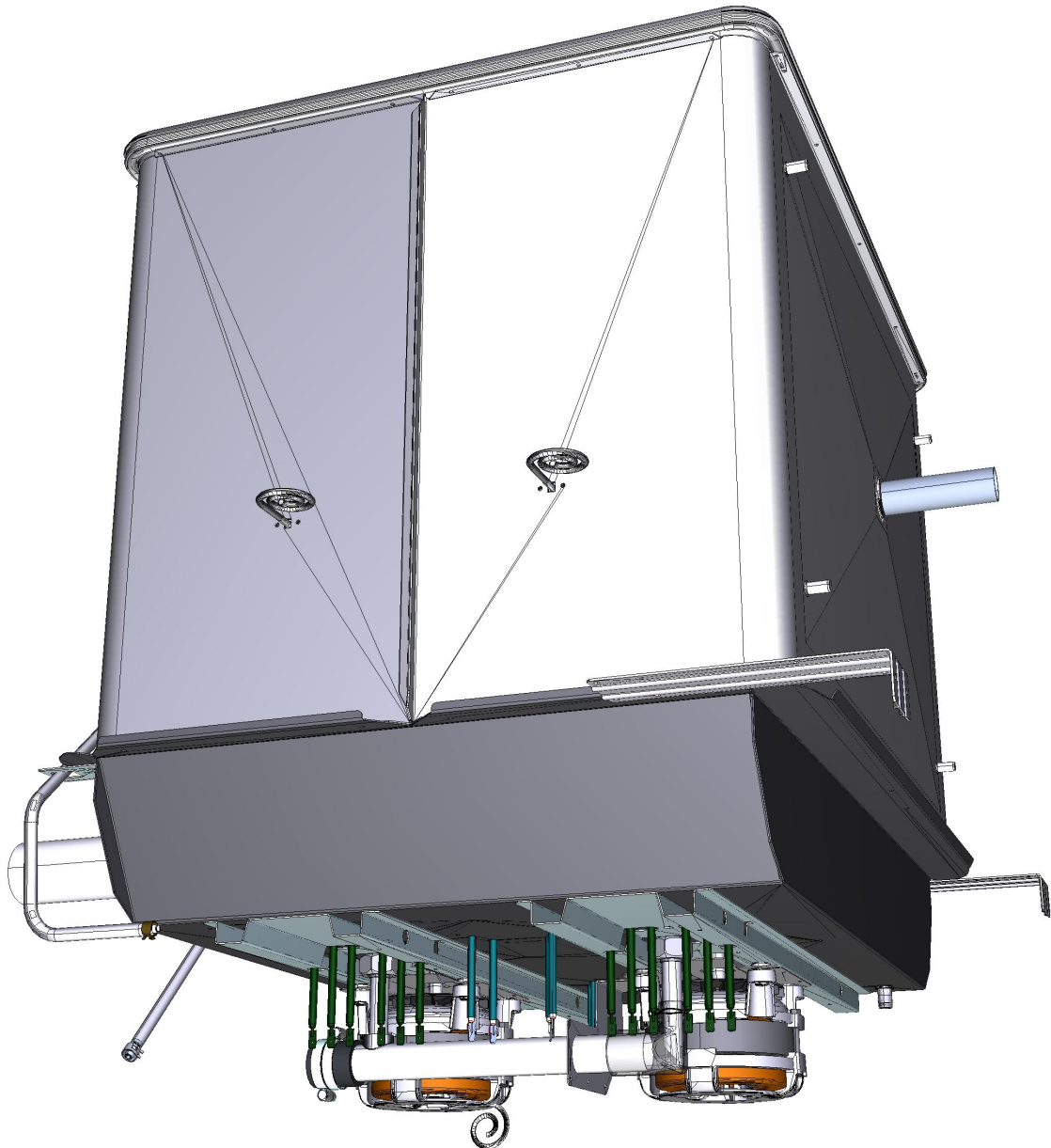

RETRO





COMPONENTE			RICAMBIO																										
Codice	Descrizione	Immagine	Codice	Descrizione	Lista componenti																								
GN1326A	GUARNIZIONE RESISTENZA 71X19 G6.25		KRS1261A	KIT RESISTENZA FRENATA 122W	<table border="1"> <thead> <tr> <th>Codice</th> <th>Descrizione</th> <th>Qtà</th> <th>UM</th> </tr> </thead> <tbody> <tr> <td>GN1326A1</td> <td>GUARNIZIONE RESISTENZA 71X19 G6.25</td> <td>1</td> <td>PZ</td> </tr> <tr> <td>RS1261A0</td> <td>RESISTENZA MOTORE BAKERLUX\CH EFLUX</td> <td>1</td> <td>PZ</td> </tr> <tr> <td>SL1045A0</td> <td>SILICONE ANTRACITE S53 80 ML</td> <td>1</td> <td>PZ</td> </tr> <tr> <td>VI1220A1</td> <td>VITE AUTOFILETTA NTE 4.2X11 TCS+ MARUTE</td> <td>2</td> <td>PZ</td> </tr> <tr> <td>VM2147A0</td> <td>SPUGNA ESD ROSA LISCIA 410X343X15 M</td> <td>1</td> <td>PZ</td> </tr> </tbody> </table>	Codice	Descrizione	Qtà	UM	GN1326A1	GUARNIZIONE RESISTENZA 71X19 G6.25	1	PZ	RS1261A0	RESISTENZA MOTORE BAKERLUX\CH EFLUX	1	PZ	SL1045A0	SILICONE ANTRACITE S53 80 ML	1	PZ	VI1220A1	VITE AUTOFILETTA NTE 4.2X11 TCS+ MARUTE	2	PZ	VM2147A0	SPUGNA ESD ROSA LISCIA 410X343X15 M	1	PZ
			Codice	Descrizione	Qtà	UM																							
			GN1326A1	GUARNIZIONE RESISTENZA 71X19 G6.25	1	PZ																							
RS1261A0	RESISTENZA MOTORE BAKERLUX\CH EFLUX	1	PZ																										
SL1045A0	SILICONE ANTRACITE S53 80 ML	1	PZ																										
VI1220A1	VITE AUTOFILETTA NTE 4.2X11 TCS+ MARUTE	2	PZ																										
VM2147A0	SPUGNA ESD ROSA LISCIA 410X343X15 M	1	PZ																										
KRS1215A	KIT RESISTENZA FRENATA 147W	<table border="1"> <thead> <tr> <th>Codice</th> <th>Descrizione</th> <th>Qtà</th> <th>UM</th> </tr> </thead> <tbody> <tr> <td>GN1326A1</td> <td>GUARNIZIONE RESISTENZA 71X19 G6.25</td> <td>1</td> <td>PZ</td> </tr> <tr> <td>RS1215A1</td> <td>RESISTENZA FRENATA 147W 105V 1 SPIRA</td> <td>1</td> <td>PZ</td> </tr> <tr> <td>SL1045A0</td> <td>SILICONE ANTRACITE S53 80 ML</td> <td>1</td> <td>PZ</td> </tr> <tr> <td>VI1220A1</td> <td>VITE AUTOFILETTA NTE 4.2X11 TCS+ MARUTE</td> <td>2</td> <td>PZ</td> </tr> <tr> <td>VM2147A0</td> <td>SPUGNA ESD ROSA LISCIA 410X343X15 M</td> <td>1</td> <td>PZ</td> </tr> </tbody> </table>	Codice	Descrizione	Qtà	UM	GN1326A1	GUARNIZIONE RESISTENZA 71X19 G6.25	1	PZ	RS1215A1	RESISTENZA FRENATA 147W 105V 1 SPIRA	1	PZ	SL1045A0	SILICONE ANTRACITE S53 80 ML	1	PZ	VI1220A1	VITE AUTOFILETTA NTE 4.2X11 TCS+ MARUTE	2	PZ	VM2147A0	SPUGNA ESD ROSA LISCIA 410X343X15 M	1	PZ			
Codice	Descrizione	Qtà	UM																										
GN1326A1	GUARNIZIONE RESISTENZA 71X19 G6.25	1	PZ																										
RS1215A1	RESISTENZA FRENATA 147W 105V 1 SPIRA	1	PZ																										
SL1045A0	SILICONE ANTRACITE S53 80 ML	1	PZ																										
VI1220A1	VITE AUTOFILETTA NTE 4.2X11 TCS+ MARUTE	2	PZ																										
VM2147A0	SPUGNA ESD ROSA LISCIA 410X343X15 M	1	PZ																										
KRS1095A	KIT RESISTENZA 1.2KW	<table border="1"> <thead> <tr> <th>Codice</th> <th>Descrizione</th> <th>Qtà</th> <th>UM</th> </tr> </thead> <tbody> <tr> <td>GN1326A1</td> <td>GUARNIZIONE RESISTENZA 71X19 G6.25</td> <td>1</td> <td>PZ</td> </tr> <tr> <td>IP1385A0</td> <td>IMBALLO POLISTIROLO ANGOLARE 110X80X2000</td> <td>1.200</td> <td>PZ</td> </tr> <tr> <td>IP1385A1</td> <td>IMB POL ANGOLARE 110X80X2000 D30</td> <td>0.500</td> <td>M</td> </tr> <tr> <td>RS1095A1</td> <td>RESISTENZA PIANA 1200W 230V</td> <td>1</td> <td>PZ</td> </tr> <tr> <td>SL1045A0</td> <td>SILICONE ANTRACITE S53 80 ML</td> <td>1</td> <td>PZ</td> </tr> </tbody> </table>	Codice	Descrizione	Qtà	UM	GN1326A1	GUARNIZIONE RESISTENZA 71X19 G6.25	1	PZ	IP1385A0	IMBALLO POLISTIROLO ANGOLARE 110X80X2000	1.200	PZ	IP1385A1	IMB POL ANGOLARE 110X80X2000 D30	0.500	M	RS1095A1	RESISTENZA PIANA 1200W 230V	1	PZ	SL1045A0	SILICONE ANTRACITE S53 80 ML	1	PZ			
Codice	Descrizione	Qtà	UM																										
GN1326A1	GUARNIZIONE RESISTENZA 71X19 G6.25	1	PZ																										
IP1385A0	IMBALLO POLISTIROLO ANGOLARE 110X80X2000	1.200	PZ																										
IP1385A1	IMB POL ANGOLARE 110X80X2000 D30	0.500	M																										
RS1095A1	RESISTENZA PIANA 1200W 230V	1	PZ																										
SL1045A0	SILICONE ANTRACITE S53 80 ML	1	PZ																										

COMPONENTE			RICAMBIO																											
Codice	Descrizione	Immagine	Codice	Descrizione	Lista componenti																									
GN1326A	GUARNIZIONE RESISTENZA 71X19 G6.25		KRS1095A	KIT RESISTENZA 1.2KW	<table border="1"> <thead> <tr> <th>Codice</th> <th>Descrizione</th> <th>Qtà</th> <th>UM</th> </tr> </thead> <tbody> <tr> <td>VI1220A1</td> <td>VITE AUTOFILETTA NTE 4.2X11 TCS+ MARUTE</td> <td>2</td> <td>PZ</td> </tr> <tr> <td>VM1059A1</td> <td>FILM TERMORETRA IBILE H800</td> <td>1.200</td> <td>M</td> </tr> </tbody> </table>	Codice	Descrizione	Qtà	UM	VI1220A1	VITE AUTOFILETTA NTE 4.2X11 TCS+ MARUTE	2	PZ	VM1059A1	FILM TERMORETRA IBILE H800	1.200	M													
			Codice	Descrizione	Qtà	UM																								
			VI1220A1	VITE AUTOFILETTA NTE 4.2X11 TCS+ MARUTE	2	PZ																								
			VM1059A1	FILM TERMORETRA IBILE H800	1.200	M																								
KRS1012A	KIT RESISTENZA 1365W 120V	<table border="1"> <thead> <tr> <th>Codice</th> <th>Descrizione</th> <th>Qtà</th> <th>UM</th> </tr> </thead> <tbody> <tr> <td>GN1326A1</td> <td>GUARNIZIONE RESISTENZA 71X19 G6.25</td> <td>1</td> <td>PZ</td> </tr> <tr> <td>RS1012A0</td> <td>RESISTENZA CIRCOLARE 1365W 120V</td> <td>1</td> <td>PZ</td> </tr> <tr> <td>VI1220A1</td> <td>VITE AUTOFILETTA NTE 4.2X11 TCS+ MARUTE</td> <td>5</td> <td>PZ</td> </tr> <tr> <td>VM1794A0</td> <td>FASCETTA 250X4.8 PA66 NERA</td> <td>2</td> <td>PZ</td> </tr> <tr> <td>VM2103A0</td> <td>PIASTRINA FERMAFASCE TTA</td> <td>2</td> <td>PZ</td> </tr> </tbody> </table>	Codice	Descrizione	Qtà	UM	GN1326A1	GUARNIZIONE RESISTENZA 71X19 G6.25	1	PZ	RS1012A0	RESISTENZA CIRCOLARE 1365W 120V	1	PZ	VI1220A1	VITE AUTOFILETTA NTE 4.2X11 TCS+ MARUTE	5	PZ	VM1794A0	FASCETTA 250X4.8 PA66 NERA	2	PZ	VM2103A0	PIASTRINA FERMAFASCE TTA	2	PZ				
Codice	Descrizione	Qtà	UM																											
GN1326A1	GUARNIZIONE RESISTENZA 71X19 G6.25	1	PZ																											
RS1012A0	RESISTENZA CIRCOLARE 1365W 120V	1	PZ																											
VI1220A1	VITE AUTOFILETTA NTE 4.2X11 TCS+ MARUTE	5	PZ																											
VM1794A0	FASCETTA 250X4.8 PA66 NERA	2	PZ																											
VM2103A0	PIASTRINA FERMAFASCE TTA	2	PZ																											
KRS1011A	KIT RESISTENZA ROBERTA/LISA	<table border="1"> <thead> <tr> <th>Codice</th> <th>Descrizione</th> <th>Qtà</th> <th>UM</th> </tr> </thead> <tbody> <tr> <td>GN1326A1</td> <td>GUARNIZIONE RESISTENZA 71X19 G6.25</td> <td>1</td> <td>PZ</td> </tr> <tr> <td>RS1011A0</td> <td>RESISTENZA CIRCOLARE 2560W 220-230</td> <td>1</td> <td>PZ</td> </tr> <tr> <td>SL1045A0</td> <td>SILICONE ANTRACITE S53 80 ML</td> <td>1</td> <td>PZ</td> </tr> <tr> <td>VI1220A1</td> <td>VITE AUTOFILETTA NTE 4.2X11 TCS+ MARUTE</td> <td>5</td> <td>PZ</td> </tr> <tr> <td>VM1794A0</td> <td>FASCETTA 250X4.8 PA66 NERA</td> <td>2</td> <td>PZ</td> </tr> <tr> <td>VM2103A0</td> <td>PIASTRINA FERMAFASCE TTA</td> <td>2</td> <td>PZ</td> </tr> </tbody> </table>	Codice	Descrizione	Qtà	UM	GN1326A1	GUARNIZIONE RESISTENZA 71X19 G6.25	1	PZ	RS1011A0	RESISTENZA CIRCOLARE 2560W 220-230	1	PZ	SL1045A0	SILICONE ANTRACITE S53 80 ML	1	PZ	VI1220A1	VITE AUTOFILETTA NTE 4.2X11 TCS+ MARUTE	5	PZ	VM1794A0	FASCETTA 250X4.8 PA66 NERA	2	PZ	VM2103A0	PIASTRINA FERMAFASCE TTA	2	PZ
Codice	Descrizione	Qtà	UM																											
GN1326A1	GUARNIZIONE RESISTENZA 71X19 G6.25	1	PZ																											
RS1011A0	RESISTENZA CIRCOLARE 2560W 220-230	1	PZ																											
SL1045A0	SILICONE ANTRACITE S53 80 ML	1	PZ																											
VI1220A1	VITE AUTOFILETTA NTE 4.2X11 TCS+ MARUTE	5	PZ																											
VM1794A0	FASCETTA 250X4.8 PA66 NERA	2	PZ																											
VM2103A0	PIASTRINA FERMAFASCE TTA	2	PZ																											
KRS0090A	KIT RESISTENZA 1.26KW	<table border="1"> <thead> <tr> <th>Codice</th> <th>Descrizione</th> <th>Qtà</th> <th>UM</th> </tr> </thead> <tbody> <tr> <td>GN1326A1</td> <td>GUARNIZIONE RESISTENZA 71X19 G6.25</td> <td>1</td> <td>PZ</td> </tr> <tr> <td>RS0090A0</td> <td>RESISTENZA CIRCOLARE 1260W 220-230</td> <td>1</td> <td>PZ</td> </tr> </tbody> </table>	Codice	Descrizione	Qtà	UM	GN1326A1	GUARNIZIONE RESISTENZA 71X19 G6.25	1	PZ	RS0090A0	RESISTENZA CIRCOLARE 1260W 220-230	1	PZ																
Codice	Descrizione	Qtà	UM																											
GN1326A1	GUARNIZIONE RESISTENZA 71X19 G6.25	1	PZ																											
RS0090A0	RESISTENZA CIRCOLARE 1260W 220-230	1	PZ																											

COMPONENTE			RICAMBIO																							
Codice	Descrizione	Immagine	Codice	Descrizione	Lista componenti																					
GN1326A	GUARNIZIONE RESISTENZA 71X19 G6.25		KRS0090A	KIT RESISTENZA 1.26KW	<table border="1"> <thead> <tr> <th>Codice</th> <th>Descrizione</th> <th>Qtà</th> <th>UM</th> </tr> </thead> <tbody> <tr> <td>VI1220A1</td> <td>VITE AUTOFILETTA NTE 4.2X11 TCS+ MARUTE</td> <td>3</td> <td>PZ</td> </tr> <tr> <td>VM1794A0</td> <td>FASCETTA 250X4.8 PA66 NERA</td> <td>2</td> <td>PZ</td> </tr> <tr> <td>VM2103A0</td> <td>PIASTRINA FERMAFASCE TTA</td> <td>2</td> <td>PZ</td> </tr> </tbody> </table>	Codice	Descrizione	Qtà	UM	VI1220A1	VITE AUTOFILETTA NTE 4.2X11 TCS+ MARUTE	3	PZ	VM1794A0	FASCETTA 250X4.8 PA66 NERA	2	PZ	VM2103A0	PIASTRINA FERMAFASCE TTA	2	PZ					
			Codice	Descrizione	Qtà	UM																				
			VI1220A1	VITE AUTOFILETTA NTE 4.2X11 TCS+ MARUTE	3	PZ																				
			VM1794A0	FASCETTA 250X4.8 PA66 NERA	2	PZ																				
VM2103A0	PIASTRINA FERMAFASCE TTA	2	PZ																							
KRS0050A	KIT RESISTENZA 0.5KW	<table border="1"> <thead> <tr> <th>Codice</th> <th>Descrizione</th> <th>Qtà</th> <th>UM</th> </tr> </thead> <tbody> <tr> <td>GN1326A1</td> <td>GUARNIZIONE RESISTENZA 71X19 G6.25</td> <td>1</td> <td>PZ</td> </tr> <tr> <td>IP1075A1</td> <td>IMB POL 70X150X765 D=10 CON PRETAGLIO</td> <td>1</td> <td>PZ</td> </tr> <tr> <td>IP1080A1</td> <td>IMB POL 280X255X10 D=10</td> <td>1</td> <td>PZ</td> </tr> <tr> <td>RS0050A0</td> <td>RESISTENZA PIANA 500W 220-230V</td> <td>1</td> <td>PZ</td> </tr> <tr> <td>VI1220A1</td> <td>VITE AUTOFILETTA NTE 4.2X11 TCS+ MARUTE</td> <td>2</td> <td>PZ</td> </tr> </tbody> </table>	Codice	Descrizione	Qtà	UM	GN1326A1	GUARNIZIONE RESISTENZA 71X19 G6.25	1	PZ	IP1075A1	IMB POL 70X150X765 D=10 CON PRETAGLIO	1	PZ	IP1080A1	IMB POL 280X255X10 D=10	1	PZ	RS0050A0	RESISTENZA PIANA 500W 220-230V	1	PZ	VI1220A1	VITE AUTOFILETTA NTE 4.2X11 TCS+ MARUTE	2	PZ
Codice	Descrizione	Qtà	UM																							
GN1326A1	GUARNIZIONE RESISTENZA 71X19 G6.25	1	PZ																							
IP1075A1	IMB POL 70X150X765 D=10 CON PRETAGLIO	1	PZ																							
IP1080A1	IMB POL 280X255X10 D=10	1	PZ																							
RS0050A0	RESISTENZA PIANA 500W 220-230V	1	PZ																							
VI1220A1	VITE AUTOFILETTA NTE 4.2X11 TCS+ MARUTE	2	PZ																							
KRS0011A	KIT RESISTENZA 1.465KW RS0011A	<table border="1"> <thead> <tr> <th>Codice</th> <th>Descrizione</th> <th>Qtà</th> <th>UM</th> </tr> </thead> <tbody> <tr> <td>GN1326A1</td> <td>GUARNIZIONE RESISTENZA 71X19 G6.25</td> <td>1</td> <td>PZ</td> </tr> <tr> <td>RS0011A0</td> <td>RESISTENZA CIRCOLARE 1465W 220-230</td> <td>1</td> <td>PZ</td> </tr> <tr> <td>VI1220A1</td> <td>VITE AUTOFILETTA NTE 4.2X11 TCS+ MARUTE</td> <td>3</td> <td>PZ</td> </tr> <tr> <td>VM1794A0</td> <td>FASCETTA 250X4.8 PA66 NERA</td> <td>2</td> <td>PZ</td> </tr> <tr> <td>VM2103A0</td> <td>PIASTRINA FERMAFASCE TTA</td> <td>2</td> <td>PZ</td> </tr> </tbody> </table>	Codice	Descrizione	Qtà	UM	GN1326A1	GUARNIZIONE RESISTENZA 71X19 G6.25	1	PZ	RS0011A0	RESISTENZA CIRCOLARE 1465W 220-230	1	PZ	VI1220A1	VITE AUTOFILETTA NTE 4.2X11 TCS+ MARUTE	3	PZ	VM1794A0	FASCETTA 250X4.8 PA66 NERA	2	PZ	VM2103A0	PIASTRINA FERMAFASCE TTA	2	PZ
Codice	Descrizione	Qtà	UM																							
GN1326A1	GUARNIZIONE RESISTENZA 71X19 G6.25	1	PZ																							
RS0011A0	RESISTENZA CIRCOLARE 1465W 220-230	1	PZ																							
VI1220A1	VITE AUTOFILETTA NTE 4.2X11 TCS+ MARUTE	3	PZ																							
VM1794A0	FASCETTA 250X4.8 PA66 NERA	2	PZ																							
VM2103A0	PIASTRINA FERMAFASCE TTA	2	PZ																							
KRS0010A	KIT RESISTENZA RS0010A	<table border="1"> <thead> <tr> <th>Codice</th> <th>Descrizione</th> <th>Qtà</th> <th>UM</th> </tr> </thead> <tbody> <tr> <td>GN1326A1</td> <td>GUARNIZIONE RESISTENZA 71X19 G6.25</td> <td>1</td> <td>PZ</td> </tr> </tbody> </table>	Codice	Descrizione	Qtà	UM	GN1326A1	GUARNIZIONE RESISTENZA 71X19 G6.25	1	PZ																
Codice	Descrizione	Qtà	UM																							
GN1326A1	GUARNIZIONE RESISTENZA 71X19 G6.25	1	PZ																							



COMPONENTE			RICAMBIO																										
Codice	Descrizione	Immagine	Codice	Descrizione	Lista componenti																								
GN1326A	GUARNIZIONE RESISTENZA 71X19 G6.25		KRS0010A	KIT RESISTENZA RS0010A	<table border="1"> <thead> <tr> <th>Codice</th> <th>Descrizione</th> <th>Qtà</th> <th>UM</th> </tr> </thead> <tbody> <tr> <td>IP1075A1</td> <td>IMB POL 70X150X765 D=10 CON PRETAGLIO</td> <td>1</td> <td>PZ</td> </tr> <tr> <td>IP1080A1</td> <td>IMB POL 280X255X10 D=10</td> <td>5</td> <td>PZ</td> </tr> <tr> <td>RS0010A0</td> <td>RESISTENZA CIRCOLARE 2560W 220-230</td> <td>1</td> <td>PZ</td> </tr> <tr> <td>VI1220A1</td> <td>VITE AUTOFILETTA NTE 4.2X11 TCS+ MARUTE</td> <td>3</td> <td>PZ</td> </tr> </tbody> </table>	Codice	Descrizione	Qtà	UM	IP1075A1	IMB POL 70X150X765 D=10 CON PRETAGLIO	1	PZ	IP1080A1	IMB POL 280X255X10 D=10	5	PZ	RS0010A0	RESISTENZA CIRCOLARE 2560W 220-230	1	PZ	VI1220A1	VITE AUTOFILETTA NTE 4.2X11 TCS+ MARUTE	3	PZ				
			Codice	Descrizione	Qtà	UM																							
IP1075A1	IMB POL 70X150X765 D=10 CON PRETAGLIO	1	PZ																										
IP1080A1	IMB POL 280X255X10 D=10	5	PZ																										
RS0010A0	RESISTENZA CIRCOLARE 2560W 220-230	1	PZ																										
VI1220A1	VITE AUTOFILETTA NTE 4.2X11 TCS+ MARUTE	3	PZ																										
KGN1326A	KIT 5 PZ GUARNIZIONE RESISTENZA	<table border="1"> <thead> <tr> <th>Codice</th> <th>Descrizione</th> <th>Qtà</th> <th>UM</th> </tr> </thead> <tbody> <tr> <td>GN1326A1</td> <td>GUARNIZIONE RESISTENZA 71X19 G6.25</td> <td>5</td> <td>PZ</td> </tr> </tbody> </table>	Codice	Descrizione	Qtà	UM	GN1326A1	GUARNIZIONE RESISTENZA 71X19 G6.25	5	PZ																			
Codice	Descrizione	Qtà	UM																										
GN1326A1	GUARNIZIONE RESISTENZA 71X19 G6.25	5	PZ																										
RS1274A	RESISTENZA PIANA 100W 60V 1 SPIRA		KRS1274A	GN1326A1 KIT RESISTENZA DI FRENATA 100W	<table border="1"> <thead> <tr> <th>Codice</th> <th>Descrizione</th> <th>Qtà</th> <th>UM</th> </tr> </thead> <tbody> <tr> <td>GN1326A1</td> <td>GUARNIZIONE RESISTENZA 71X19 G6.25</td> <td>1</td> <td>PZ</td> </tr> <tr> <td>RS1274A0</td> <td>RESISTENZA PIANA 100W 60V 1 SPIRA</td> <td>1</td> <td>PZ</td> </tr> <tr> <td>SL1045A0</td> <td>SILICONE ANTRACITE S53 80 ML</td> <td>1</td> <td>PZ</td> </tr> <tr> <td>VI1220A1</td> <td>VITE AUTOFILETTA NTE 4.2X11 TCS+ MARUTE</td> <td>2</td> <td>PZ</td> </tr> </tbody> </table>	Codice	Descrizione	Qtà	UM	GN1326A1	GUARNIZIONE RESISTENZA 71X19 G6.25	1	PZ	RS1274A0	RESISTENZA PIANA 100W 60V 1 SPIRA	1	PZ	SL1045A0	SILICONE ANTRACITE S53 80 ML	1	PZ	VI1220A1	VITE AUTOFILETTA NTE 4.2X11 TCS+ MARUTE	2	PZ				
					Codice	Descrizione	Qtà	UM																					
					GN1326A1	GUARNIZIONE RESISTENZA 71X19 G6.25	1	PZ																					
					RS1274A0	RESISTENZA PIANA 100W 60V 1 SPIRA	1	PZ																					
SL1045A0	SILICONE ANTRACITE S53 80 ML	1	PZ																										
VI1220A1	VITE AUTOFILETTA NTE 4.2X11 TCS+ MARUTE	2	PZ																										
GN1285A	GUARNIZIONE SONDA DI TEMPERATURA NTC		KTR1106A	KIT SONDA TEMP. CAMERA L2000 S.5-5	<table border="1"> <thead> <tr> <th>Codice</th> <th>Descrizione</th> <th>Qtà</th> <th>UM</th> </tr> </thead> <tbody> <tr> <td>GN1285A0</td> <td>GUARNIZIONE SONDA DI TEMPERATUR A NTC</td> <td>1</td> <td>PZ</td> </tr> <tr> <td>SL1045A0</td> <td>SILICONE ANTRACITE S53 80 ML</td> <td>1</td> <td>PZ</td> </tr> <tr> <td>TR1106A3</td> <td>SONDA TEMPERATUR A PT100 L2000</td> <td>1</td> <td>PZ</td> </tr> <tr> <td>VI1220A1</td> <td>VITE AUTOFILETTA NTE 4.2X11 TCS+ MARUTE</td> <td>2</td> <td>PZ</td> </tr> <tr> <td>VM1465A0</td> <td>COPERCHIO SONDA TEMPERATUR A CHEFTOP</td> <td>1</td> <td>PZ</td> </tr> </tbody> </table>	Codice	Descrizione	Qtà	UM	GN1285A0	GUARNIZIONE SONDA DI TEMPERATUR A NTC	1	PZ	SL1045A0	SILICONE ANTRACITE S53 80 ML	1	PZ	TR1106A3	SONDA TEMPERATUR A PT100 L2000	1	PZ	VI1220A1	VITE AUTOFILETTA NTE 4.2X11 TCS+ MARUTE	2	PZ	VM1465A0	COPERCHIO SONDA TEMPERATUR A CHEFTOP	1	PZ
Codice	Descrizione				Qtà	UM																							
GN1285A0	GUARNIZIONE SONDA DI TEMPERATUR A NTC				1	PZ																							
SL1045A0	SILICONE ANTRACITE S53 80 ML				1	PZ																							
TR1106A3	SONDA TEMPERATUR A PT100 L2000				1	PZ																							
VI1220A1	VITE AUTOFILETTA NTE 4.2X11 TCS+ MARUTE	2	PZ																										
VM1465A0	COPERCHIO SONDA TEMPERATUR A CHEFTOP	1	PZ																										





COMPONENTE			RICAMBIO																																		
Codice	Descrizione	Immagine	Codice	Descrizione	Lista componenti																																
GN1285A	GUARNIZIONE SONDA DI TEMPERATURA NTC		KTR1105A	KIT SONDA TEMPERATURA PT100 L1000	<table border="1"> <thead> <tr> <th>Codice</th> <th>Descrizione</th> <th>Qtà</th> <th>UM</th> </tr> </thead> <tbody> <tr> <td>GN1120A0</td> <td>GUARNIZIONE SONDA DI TEMPERATUR A NTC</td> <td>1</td> <td>PZ</td> </tr> <tr> <td>GN1285A0</td> <td>GUARNIZIONE SONDA DI TEMPERATUR A NTC</td> <td>1</td> <td>PZ</td> </tr> <tr> <td>SL1045A0</td> <td>SILICONE ANTRACITE S53 80 ML</td> <td>1</td> <td>PZ</td> </tr> <tr> <td>TR1105A3</td> <td>SONDA TEMPERATUR A PT100 L1000</td> <td>1</td> <td>PZ</td> </tr> <tr> <td>TR1105A4</td> <td>SONDA TEMPERATUR A PT100 L1000</td> <td>1</td> <td>PZ</td> </tr> <tr> <td>VI1220A1</td> <td>VITE AUTOFILETTA NTE 4.2X11 TCS+ MARUTE</td> <td>2</td> <td>PZ</td> </tr> <tr> <td>VM1465A0</td> <td>COPERCHIO SONDA TEMPERATUR A CHEFTOP</td> <td>1</td> <td>PZ</td> </tr> </tbody> </table>	Codice	Descrizione	Qtà	UM	GN1120A0	GUARNIZIONE SONDA DI TEMPERATUR A NTC	1	PZ	GN1285A0	GUARNIZIONE SONDA DI TEMPERATUR A NTC	1	PZ	SL1045A0	SILICONE ANTRACITE S53 80 ML	1	PZ	TR1105A3	SONDA TEMPERATUR A PT100 L1000	1	PZ	TR1105A4	SONDA TEMPERATUR A PT100 L1000	1	PZ	VI1220A1	VITE AUTOFILETTA NTE 4.2X11 TCS+ MARUTE	2	PZ	VM1465A0	COPERCHIO SONDA TEMPERATUR A CHEFTOP	1	PZ
			Codice	Descrizione	Qtà	UM																															
GN1120A0	GUARNIZIONE SONDA DI TEMPERATUR A NTC	1	PZ																																		
GN1285A0	GUARNIZIONE SONDA DI TEMPERATUR A NTC	1	PZ																																		
SL1045A0	SILICONE ANTRACITE S53 80 ML	1	PZ																																		
TR1105A3	SONDA TEMPERATUR A PT100 L1000	1	PZ																																		
TR1105A4	SONDA TEMPERATUR A PT100 L1000	1	PZ																																		
VI1220A1	VITE AUTOFILETTA NTE 4.2X11 TCS+ MARUTE	2	PZ																																		
VM1465A0	COPERCHIO SONDA TEMPERATUR A CHEFTOP	1	PZ																																		
KTR1096A	KIT SONDA TEMPERATURA NTC 150 L=1500	<table border="1"> <thead> <tr> <th>Codice</th> <th>Descrizione</th> <th>Qtà</th> <th>UM</th> </tr> </thead> <tbody> <tr> <td>GN1120A0</td> <td>GUARNIZIONE SONDA DI TEMPERATUR A NTC</td> <td>1</td> <td>PZ</td> </tr> <tr> <td>GN1285A0</td> <td>GUARNIZIONE SONDA DI TEMPERATUR A NTC</td> <td>2</td> <td>PZ</td> </tr> <tr> <td>SL1045A0</td> <td>SILICONE ANTRACITE S53 80 ML</td> <td>1</td> <td>PZ</td> </tr> <tr> <td>TR1096A0</td> <td>SONDA TEMPERATUR A NTC 150 L=1500</td> <td>1</td> <td>PZ</td> </tr> <tr> <td>VI1220A1</td> <td>VITE AUTOFILETTA NTE 4.2X11 TCS+ MARUTE</td> <td>2</td> <td>PZ</td> </tr> <tr> <td>VM1465A0</td> <td>COPERCHIO SONDA TEMPERATUR A CHEFTOP</td> <td>1</td> <td>PZ</td> </tr> </tbody> </table>	Codice	Descrizione	Qtà	UM	GN1120A0	GUARNIZIONE SONDA DI TEMPERATUR A NTC	1	PZ	GN1285A0	GUARNIZIONE SONDA DI TEMPERATUR A NTC	2	PZ	SL1045A0	SILICONE ANTRACITE S53 80 ML	1	PZ	TR1096A0	SONDA TEMPERATUR A NTC 150 L=1500	1	PZ	VI1220A1	VITE AUTOFILETTA NTE 4.2X11 TCS+ MARUTE	2	PZ	VM1465A0	COPERCHIO SONDA TEMPERATUR A CHEFTOP	1	PZ							
Codice	Descrizione	Qtà	UM																																		
GN1120A0	GUARNIZIONE SONDA DI TEMPERATUR A NTC	1	PZ																																		
GN1285A0	GUARNIZIONE SONDA DI TEMPERATUR A NTC	2	PZ																																		
SL1045A0	SILICONE ANTRACITE S53 80 ML	1	PZ																																		
TR1096A0	SONDA TEMPERATUR A NTC 150 L=1500	1	PZ																																		
VI1220A1	VITE AUTOFILETTA NTE 4.2X11 TCS+ MARUTE	2	PZ																																		
VM1465A0	COPERCHIO SONDA TEMPERATUR A CHEFTOP	1	PZ																																		

COMPONENTE			RICAMBIO																														
Codice	Descrizione	Immagine	Codice	Descrizione	Lista componenti																												
GN1285A	GUARNIZIONE SONDA DI TEMPERATURA NTC		KTR1095A	KIT SONDA TEMPERATURA NTC 150 L=1050	<table border="1"> <thead> <tr> <th>Codice</th> <th>Descrizione</th> <th>Qtà</th> <th>UM</th> </tr> </thead> <tbody> <tr> <td>GN1120A0</td> <td>GUARNIZIONE SONDA DI TEMPERATUR A NTC</td> <td>1</td> <td>PZ</td> </tr> <tr> <td>GN1285A0</td> <td>GUARNIZIONE SONDA DI TEMPERATUR A NTC</td> <td>1</td> <td>PZ</td> </tr> <tr> <td>SL1045A0</td> <td>SILICONE ANTRACITE S53 80 ML</td> <td>1</td> <td>PZ</td> </tr> <tr> <td>TR1095A0</td> <td>SONDA TEMPERATUR A NTC 150 L=1050</td> <td>1</td> <td>PZ</td> </tr> <tr> <td>VI1220A1</td> <td>VITE AUTOFILETTA NTE 4.2X11 TCS+ MARUTE</td> <td>2</td> <td>PZ</td> </tr> <tr> <td>VM1465A0</td> <td>COPERCHIO SONDA TEMPERATUR A CHEFTOP</td> <td>1</td> <td>PZ</td> </tr> </tbody> </table>	Codice	Descrizione	Qtà	UM	GN1120A0	GUARNIZIONE SONDA DI TEMPERATUR A NTC	1	PZ	GN1285A0	GUARNIZIONE SONDA DI TEMPERATUR A NTC	1	PZ	SL1045A0	SILICONE ANTRACITE S53 80 ML	1	PZ	TR1095A0	SONDA TEMPERATUR A NTC 150 L=1050	1	PZ	VI1220A1	VITE AUTOFILETTA NTE 4.2X11 TCS+ MARUTE	2	PZ	VM1465A0	COPERCHIO SONDA TEMPERATUR A CHEFTOP	1	PZ
			Codice	Descrizione	Qtà	UM																											
GN1120A0	GUARNIZIONE SONDA DI TEMPERATUR A NTC	1	PZ																														
GN1285A0	GUARNIZIONE SONDA DI TEMPERATUR A NTC	1	PZ																														
SL1045A0	SILICONE ANTRACITE S53 80 ML	1	PZ																														
TR1095A0	SONDA TEMPERATUR A NTC 150 L=1050	1	PZ																														
VI1220A1	VITE AUTOFILETTA NTE 4.2X11 TCS+ MARUTE	2	PZ																														
VM1465A0	COPERCHIO SONDA TEMPERATUR A CHEFTOP	1	PZ																														
KTR1002A	KIT SONDA TEMPERATURA UL PT100 L1000	<table border="1"> <thead> <tr> <th>Codice</th> <th>Descrizione</th> <th>Qtà</th> <th>UM</th> </tr> </thead> <tbody> <tr> <td>GN1285A0</td> <td>GUARNIZIONE SONDA DI TEMPERATUR A NTC</td> <td>2</td> <td>PZ</td> </tr> <tr> <td>SL1045A0</td> <td>SILICONE ANTRACITE S53 80 ML</td> <td>1</td> <td>PZ</td> </tr> <tr> <td>TR1002A0</td> <td>SONDA TEMPERATUR A UL PT100 L1000</td> <td>1</td> <td>PZ</td> </tr> <tr> <td>VI1220A1</td> <td>VITE AUTOFILETTA NTE 4.2X11 TCS+ MARUTE</td> <td>2</td> <td>PZ</td> </tr> <tr> <td>VM1465A0</td> <td>COPERCHIO SONDA TEMPERATUR A CHEFTOP</td> <td>1</td> <td>PZ</td> </tr> </tbody> </table>	Codice	Descrizione	Qtà	UM	GN1285A0	GUARNIZIONE SONDA DI TEMPERATUR A NTC	2	PZ	SL1045A0	SILICONE ANTRACITE S53 80 ML	1	PZ	TR1002A0	SONDA TEMPERATUR A UL PT100 L1000	1	PZ	VI1220A1	VITE AUTOFILETTA NTE 4.2X11 TCS+ MARUTE	2	PZ	VM1465A0	COPERCHIO SONDA TEMPERATUR A CHEFTOP	1	PZ							
Codice	Descrizione	Qtà	UM																														
GN1285A0	GUARNIZIONE SONDA DI TEMPERATUR A NTC	2	PZ																														
SL1045A0	SILICONE ANTRACITE S53 80 ML	1	PZ																														
TR1002A0	SONDA TEMPERATUR A UL PT100 L1000	1	PZ																														
VI1220A1	VITE AUTOFILETTA NTE 4.2X11 TCS+ MARUTE	2	PZ																														
VM1465A0	COPERCHIO SONDA TEMPERATUR A CHEFTOP	1	PZ																														
TR1106A	SONDA TEMPERATURA PT100 L2000		KTR1106B	KIT SONDA TEMP. CAMERA L2000 MIND.MAPS	<table border="1"> <thead> <tr> <th>Codice</th> <th>Descrizione</th> <th>Qtà</th> <th>UM</th> </tr> </thead> <tbody> <tr> <td>GN1285A0</td> <td>GUARNIZIONE SONDA DI TEMPERATUR A NTC</td> <td>1</td> <td>PZ</td> </tr> <tr> <td>SL1045A0</td> <td>SILICONE ANTRACITE S53 80 ML</td> <td>1</td> <td>PZ</td> </tr> </tbody> </table>	Codice	Descrizione	Qtà	UM	GN1285A0	GUARNIZIONE SONDA DI TEMPERATUR A NTC	1	PZ	SL1045A0	SILICONE ANTRACITE S53 80 ML	1	PZ																
Codice	Descrizione	Qtà	UM																														
GN1285A0	GUARNIZIONE SONDA DI TEMPERATUR A NTC	1	PZ																														
SL1045A0	SILICONE ANTRACITE S53 80 ML	1	PZ																														



COMPONENTE			RICAMBIO																							
Codice	Descrizione	Immagine	Codice	Descrizione	Lista componenti																					
TR1106A	SONDA TEMPERATURA PT100 L2000		KTR1106B	KIT SONDA TEMP. CAMERA L2000 MIND.MAPS	<table border="1"> <thead> <tr> <th>Codice</th> <th>Descrizione</th> <th>Qtà</th> <th>UM</th> </tr> </thead> <tbody> <tr> <td>TR1106B0</td> <td>SONDA TEMPERATUR A PT100 L 200</td> <td>1</td> <td>PZ</td> </tr> <tr> <td>VI1220A1</td> <td>VITE AUTOFILETTA NTE 4.2X11 TCS+ MARUTE</td> <td>2</td> <td>PZ</td> </tr> <tr> <td>VM1464A0</td> <td>COPERCHIO SONDA TEMPERATUR A CT BT CON PA</td> <td>1</td> <td>PZ</td> </tr> <tr> <td>VM1465A0</td> <td>COPERCHIO SONDA TEMPERATUR A CHEFTOP</td> <td>1</td> <td>PZ</td> </tr> </tbody> </table>	Codice	Descrizione	Qtà	UM	TR1106B0	SONDA TEMPERATUR A PT100 L 200	1	PZ	VI1220A1	VITE AUTOFILETTA NTE 4.2X11 TCS+ MARUTE	2	PZ	VM1464A0	COPERCHIO SONDA TEMPERATUR A CT BT CON PA	1	PZ	VM1465A0	COPERCHIO SONDA TEMPERATUR A CHEFTOP	1	PZ	
			Codice	Descrizione	Qtà	UM																				
TR1106B0	SONDA TEMPERATUR A PT100 L 200	1	PZ																							
VI1220A1	VITE AUTOFILETTA NTE 4.2X11 TCS+ MARUTE	2	PZ																							
VM1464A0	COPERCHIO SONDA TEMPERATUR A CT BT CON PA	1	PZ																							
VM1465A0	COPERCHIO SONDA TEMPERATUR A CHEFTOP	1	PZ																							
KTR1106A	KIT SONDA TEMP. CAMERA L2000 S.5-5	<table border="1"> <thead> <tr> <th>Codice</th> <th>Descrizione</th> <th>Qtà</th> <th>UM</th> </tr> </thead> <tbody> <tr> <td>GN1285A0</td> <td>GUARNIZIONE SONDA DI TEMPERATUR A NTC</td> <td>1</td> <td>PZ</td> </tr> <tr> <td>SL1045A0</td> <td>SILICONE ANTRACITE S53 80 ML</td> <td>1</td> <td>PZ</td> </tr> <tr> <td>TR1106A3</td> <td>SONDA TEMPERATUR A PT100 L2000</td> <td>1</td> <td>PZ</td> </tr> <tr> <td>VI1220A1</td> <td>VITE AUTOFILETTA NTE 4.2X11 TCS+ MARUTE</td> <td>2</td> <td>PZ</td> </tr> <tr> <td>VM1465A0</td> <td>COPERCHIO SONDA TEMPERATUR A CHEFTOP</td> <td>1</td> <td>PZ</td> </tr> </tbody> </table>	Codice	Descrizione	Qtà	UM	GN1285A0	GUARNIZIONE SONDA DI TEMPERATUR A NTC	1	PZ	SL1045A0	SILICONE ANTRACITE S53 80 ML	1	PZ	TR1106A3	SONDA TEMPERATUR A PT100 L2000	1	PZ	VI1220A1	VITE AUTOFILETTA NTE 4.2X11 TCS+ MARUTE	2	PZ	VM1465A0	COPERCHIO SONDA TEMPERATUR A CHEFTOP	1	PZ
Codice	Descrizione	Qtà	UM																							
GN1285A0	GUARNIZIONE SONDA DI TEMPERATUR A NTC	1	PZ																							
SL1045A0	SILICONE ANTRACITE S53 80 ML	1	PZ																							
TR1106A3	SONDA TEMPERATUR A PT100 L2000	1	PZ																							
VI1220A1	VITE AUTOFILETTA NTE 4.2X11 TCS+ MARUTE	2	PZ																							
VM1465A0	COPERCHIO SONDA TEMPERATUR A CHEFTOP	1	PZ																							
VM1464A	COPERCHIO SONDA TEMPERATURA CT BT CON PA		KVM1464A	KIT COPERCHIO SONDA TEMP CT BT VM1464A0	<table border="1"> <thead> <tr> <th>Codice</th> <th>Descrizione</th> <th>Qtà</th> <th>UM</th> </tr> </thead> <tbody> <tr> <td>VM1464A0</td> <td>COPERCHIO SONDA TEMPERATUR A CT BT CON PA</td> <td>1</td> <td>PZ</td> </tr> </tbody> </table>	Codice	Descrizione	Qtà	UM	VM1464A0	COPERCHIO SONDA TEMPERATUR A CT BT CON PA	1	PZ													
Codice	Descrizione	Qtà	UM																							
VM1464A0	COPERCHIO SONDA TEMPERATUR A CT BT CON PA	1	PZ																							

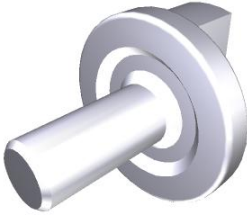



COMPONENTE			RICAMBIO																														
Codice	Descrizione	Immagine	Codice	Descrizione	Lista componenti																												
TR1003A	SONDA TEMPERATURA UL PT100 L2000 USA		KTR1003B	KIT SONDA TEMP CAMERA L2000 MINDMAPS USA	<table border="1"> <thead> <tr> <th>Codice</th> <th>Descrizione</th> <th>Qtà</th> <th>UM</th> </tr> </thead> <tbody> <tr> <td>GN1285A0</td> <td>GUARNIZIONE SONDA DI TEMPERATUR A NTC</td> <td>1</td> <td>PZ</td> </tr> <tr> <td>SL1045A0</td> <td>SILICONE ANTRACITE S53 80 ML</td> <td>1</td> <td>PZ</td> </tr> <tr> <td>TR1003B0</td> <td>SONDA TEMPERATUR A UL PT100 L 2000 USA</td> <td>1</td> <td>PZ</td> </tr> <tr> <td>VI1220A1</td> <td>VITE AUTOFILETTA NTE 4.2X11 TCS+ MARUTE</td> <td>2</td> <td>PZ</td> </tr> <tr> <td>VM1464A0</td> <td>COPERCHIO SONDA TEMPERATUR A CT BT CON PA</td> <td>1</td> <td>PZ</td> </tr> <tr> <td>VM1465A0</td> <td>COPERCHIO SONDA TEMPERATUR A CHEFTOP</td> <td>1</td> <td>PZ</td> </tr> </tbody> </table>	Codice	Descrizione	Qtà	UM	GN1285A0	GUARNIZIONE SONDA DI TEMPERATUR A NTC	1	PZ	SL1045A0	SILICONE ANTRACITE S53 80 ML	1	PZ	TR1003B0	SONDA TEMPERATUR A UL PT100 L 2000 USA	1	PZ	VI1220A1	VITE AUTOFILETTA NTE 4.2X11 TCS+ MARUTE	2	PZ	VM1464A0	COPERCHIO SONDA TEMPERATUR A CT BT CON PA	1	PZ	VM1465A0	COPERCHIO SONDA TEMPERATUR A CHEFTOP	1	PZ
			Codice	Descrizione	Qtà	UM																											
GN1285A0	GUARNIZIONE SONDA DI TEMPERATUR A NTC	1	PZ																														
SL1045A0	SILICONE ANTRACITE S53 80 ML	1	PZ																														
TR1003B0	SONDA TEMPERATUR A UL PT100 L 2000 USA	1	PZ																														
VI1220A1	VITE AUTOFILETTA NTE 4.2X11 TCS+ MARUTE	2	PZ																														
VM1464A0	COPERCHIO SONDA TEMPERATUR A CT BT CON PA	1	PZ																														
VM1465A0	COPERCHIO SONDA TEMPERATUR A CHEFTOP	1	PZ																														
KTR1003A	KIT SONDA TEMP CAMERA L2000 S 5-5E USA	<table border="1"> <thead> <tr> <th>Codice</th> <th>Descrizione</th> <th>Qtà</th> <th>UM</th> </tr> </thead> <tbody> <tr> <td>GN1285A0</td> <td>GUARNIZIONE SONDA DI TEMPERATUR A NTC</td> <td>1</td> <td>PZ</td> </tr> <tr> <td>SL1045A0</td> <td>SILICONE ANTRACITE S53 80 ML</td> <td>1</td> <td>PZ</td> </tr> <tr> <td>TR1003A0</td> <td>SONDA TEMPERATUR A UL PT100 L2000 USA</td> <td>1</td> <td>PZ</td> </tr> <tr> <td>VI1220A1</td> <td>VITE AUTOFILETTA NTE 4.2X11 TCS+ MARUTE</td> <td>2</td> <td>PZ</td> </tr> <tr> <td>VM1465A0</td> <td>COPERCHIO SONDA TEMPERATUR A CHEFTOP</td> <td>1</td> <td>PZ</td> </tr> </tbody> </table>	Codice	Descrizione	Qtà	UM	GN1285A0	GUARNIZIONE SONDA DI TEMPERATUR A NTC	1	PZ	SL1045A0	SILICONE ANTRACITE S53 80 ML	1	PZ	TR1003A0	SONDA TEMPERATUR A UL PT100 L2000 USA	1	PZ	VI1220A1	VITE AUTOFILETTA NTE 4.2X11 TCS+ MARUTE	2	PZ	VM1465A0	COPERCHIO SONDA TEMPERATUR A CHEFTOP	1	PZ							
Codice	Descrizione	Qtà	UM																														
GN1285A0	GUARNIZIONE SONDA DI TEMPERATUR A NTC	1	PZ																														
SL1045A0	SILICONE ANTRACITE S53 80 ML	1	PZ																														
TR1003A0	SONDA TEMPERATUR A UL PT100 L2000 USA	1	PZ																														
VI1220A1	VITE AUTOFILETTA NTE 4.2X11 TCS+ MARUTE	2	PZ																														
VM1465A0	COPERCHIO SONDA TEMPERATUR A CHEFTOP	1	PZ																														

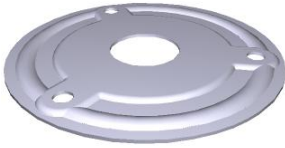
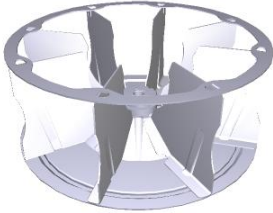

COMPONENTE			RICAMBIO																														
Codice	Descrizione	Immagine	Codice	Descrizione	Lista componenti																												
GN1531A	GUARNIZIONE TENUTA INGRESSO BULBO		KTR1136A	KIT TERMOSTATO SICUREZZA 330°C	<table border="1"> <thead> <tr> <th>Codice</th> <th>Descrizione</th> <th>Qtà</th> <th>UM</th> </tr> </thead> <tbody> <tr> <td>0H7030A0</td> <td>COPERCHIO INGRESSO BULBO</td> <td>1</td> <td>PZ</td> </tr> <tr> <td>GN1531A0</td> <td>GUARNIZIONE TENUTA INGRESSO BULBO</td> <td>1</td> <td>PZ</td> </tr> <tr> <td>SL1045A0</td> <td>SILICONE ANTRACITE S53 80 ML</td> <td>1</td> <td>PZ</td> </tr> <tr> <td>TR1136A0</td> <td>TERMOSTATO SIC. UNIP. 330°C</td> <td>1</td> <td>PZ</td> </tr> <tr> <td>VI1220A1</td> <td>VITE AUTOFILETTA NTE 4.2X11 TCS+ MARUTE</td> <td>3</td> <td>PZ</td> </tr> </tbody> </table>	Codice	Descrizione	Qtà	UM	0H7030A0	COPERCHIO INGRESSO BULBO	1	PZ	GN1531A0	GUARNIZIONE TENUTA INGRESSO BULBO	1	PZ	SL1045A0	SILICONE ANTRACITE S53 80 ML	1	PZ	TR1136A0	TERMOSTATO SIC. UNIP. 330°C	1	PZ	VI1220A1	VITE AUTOFILETTA NTE 4.2X11 TCS+ MARUTE	3	PZ				
Codice	Descrizione	Qtà	UM																														
0H7030A0	COPERCHIO INGRESSO BULBO	1	PZ																														
GN1531A0	GUARNIZIONE TENUTA INGRESSO BULBO	1	PZ																														
SL1045A0	SILICONE ANTRACITE S53 80 ML	1	PZ																														
TR1136A0	TERMOSTATO SIC. UNIP. 330°C	1	PZ																														
VI1220A1	VITE AUTOFILETTA NTE 4.2X11 TCS+ MARUTE	3	PZ																														
0H7030A	COPERCHIO INGRESSO BULBO		K0H7030A	KIT COPERCHIO INGRESSO BULBO 1PZ	<table border="1"> <thead> <tr> <th>Codice</th> <th>Descrizione</th> <th>Qtà</th> <th>UM</th> </tr> </thead> <tbody> <tr> <td>0H7030A0</td> <td>COPERCHIO INGRESSO BULBO</td> <td>1</td> <td>PZ</td> </tr> </tbody> </table>	Codice	Descrizione	Qtà	UM	0H7030A0	COPERCHIO INGRESSO BULBO	1	PZ																				
Codice	Descrizione	Qtà	UM																														
0H7030A0	COPERCHIO INGRESSO BULBO	1	PZ																														
VL1037A	GIRANTE LAVAGGIO		KVL1037A	KIT RICAMBIO GIRANTE LAVAGGIO	<table border="1"> <thead> <tr> <th>Codice</th> <th>Descrizione</th> <th>Qtà</th> <th>UM</th> </tr> </thead> <tbody> <tr> <td>GN1416B0</td> <td>BRONZINA GIRANTE LAVAGGIO</td> <td>1</td> <td>PZ</td> </tr> <tr> <td>TF1065B0</td> <td>PERNO ROTAZIONE GIRANTE LAVAGGIO</td> <td>1</td> <td>PZ</td> </tr> <tr> <td>TF1066A1</td> <td>BOCCOLA GIRANTE LAVAGGIO</td> <td>1</td> <td>PZ</td> </tr> <tr> <td>UG1005B1</td> <td>UGELLO ACQUA GETTO LARGO GIRANTE</td> <td>1</td> <td>PZ</td> </tr> <tr> <td>UG1006B3</td> <td>UGELLO ACQUA GETTO LUNGO GIRANTE</td> <td>1</td> <td>PZ</td> </tr> <tr> <td>VI1220A1</td> <td>VITE AUTOFILETTA NTE 4.2X11 TCS+ MARUTE</td> <td>6</td> <td>PZ</td> </tr> </tbody> </table>	Codice	Descrizione	Qtà	UM	GN1416B0	BRONZINA GIRANTE LAVAGGIO	1	PZ	TF1065B0	PERNO ROTAZIONE GIRANTE LAVAGGIO	1	PZ	TF1066A1	BOCCOLA GIRANTE LAVAGGIO	1	PZ	UG1005B1	UGELLO ACQUA GETTO LARGO GIRANTE	1	PZ	UG1006B3	UGELLO ACQUA GETTO LUNGO GIRANTE	1	PZ	VI1220A1	VITE AUTOFILETTA NTE 4.2X11 TCS+ MARUTE	6	PZ
Codice	Descrizione	Qtà	UM																														
GN1416B0	BRONZINA GIRANTE LAVAGGIO	1	PZ																														
TF1065B0	PERNO ROTAZIONE GIRANTE LAVAGGIO	1	PZ																														
TF1066A1	BOCCOLA GIRANTE LAVAGGIO	1	PZ																														
UG1005B1	UGELLO ACQUA GETTO LARGO GIRANTE	1	PZ																														
UG1006B3	UGELLO ACQUA GETTO LUNGO GIRANTE	1	PZ																														
VI1220A1	VITE AUTOFILETTA NTE 4.2X11 TCS+ MARUTE	6	PZ																														

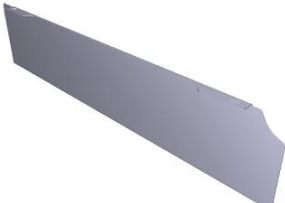

COMPONENTE			RICAMBIO																		
Codice	Descrizione	Immagine	Codice	Descrizione	Lista componenti																
VL1037A	GIRANTE LAVAGGIO		KVL1037A	KIT RICAMBIO GIRANTE LAVAGGIO	<table border="1"> <thead> <tr> <th>Codice</th> <th>Descrizione</th> <th>Qtà</th> <th>UM</th> </tr> </thead> <tbody> <tr> <td>VM1955C0</td> <td>CORPO GIRANTE LAVAGGIO</td> <td>1</td> <td>PZ</td> </tr> <tr> <td>VM1985C1</td> <td>COPERCHIO GIRANTE LAVAGGIO</td> <td>1</td> <td>PZ</td> </tr> <tr> <td>VM1986A0</td> <td>TAPPO UGELL</td> <td>1</td> <td>PZ</td> </tr> </tbody> </table>	Codice	Descrizione	Qtà	UM	VM1955C0	CORPO GIRANTE LAVAGGIO	1	PZ	VM1985C1	COPERCHIO GIRANTE LAVAGGIO	1	PZ	VM1986A0	TAPPO UGELL	1	PZ
Codice	Descrizione	Qtà	UM																		
VM1955C0	CORPO GIRANTE LAVAGGIO	1	PZ																		
VM1985C1	COPERCHIO GIRANTE LAVAGGIO	1	PZ																		
VM1986A0	TAPPO UGELL	1	PZ																		
0H2551A	TAPPO PER TUBO DI SCARICO LIQUIDI INOX C		0H2551A0	TAPPO PER TUBO DI SCARICO LIQUIDI INOX C																	
0H7320A	SUPPORTO TUBO VENTURI MM		0H7320A0	SUPPORTO TUBO VENTURI MM																	
VM1820A	NOTTOLINO M6 CROMATO FISS. SUPPORTI		KVM1820A	KIT 10 NOTTOLINI S.	<table border="1"> <thead> <tr> <th>Codice</th> <th>Descrizione</th> <th>Qtà</th> <th>UM</th> </tr> </thead> <tbody> <tr> <td>VM1820A0</td> <td>NOTTOLINO M6 CROMATO FISS. SUPPORTI</td> <td>10</td> <td>PZ</td> </tr> </tbody> </table>	Codice	Descrizione	Qtà	UM	VM1820A0	NOTTOLINO M6 CROMATO FISS. SUPPORTI	10	PZ								
Codice	Descrizione	Qtà	UM																		
VM1820A0	NOTTOLINO M6 CROMATO FISS. SUPPORTI	10	PZ																		
RC1019A	FASCETTA ELASTICA D10 ZINCATA		KRC1019A	KIT 15 PZ. FASCETTA ELASTICA D10 ZINCATA	<table border="1"> <thead> <tr> <th>Codice</th> <th>Descrizione</th> <th>Qtà</th> <th>UM</th> </tr> </thead> <tbody> <tr> <td>RC1019A0</td> <td>FASCETTA ELASTICA D10 ZINCATA</td> <td>15</td> <td>PZ</td> </tr> </tbody> </table>	Codice	Descrizione	Qtà	UM	RC1019A0	FASCETTA ELASTICA D10 ZINCATA	15	PZ								
Codice	Descrizione	Qtà	UM																		
RC1019A0	FASCETTA ELASTICA D10 ZINCATA	15	PZ																		



COMPONENTE			RICAMBIO																														
Codice	Descrizione	Immagine	Codice	Descrizione	Lista componenti																												
VM2331A	PERNO M6 FERMA CARTER-SUPPORT O TEGLIE		KVM2331A	KIT PERN M6 FERMA CARTER-SUPPORT O TEGLIE	<table border="1"> <thead> <tr> <th>Codice</th> <th>Descrizione</th> <th>Qtà</th> <th>UM</th> </tr> </thead> <tbody> <tr> <td>VM2331A0</td> <td>PERNO M6 FERMA CARTER-SUPP ORTO TEGLIE</td> <td>4</td> <td>PZ</td> </tr> </tbody> </table>	Codice	Descrizione	Qtà	UM	VM2331A0	PERNO M6 FERMA CARTER-SUPP ORTO TEGLIE	4	PZ																				
Codice	Descrizione	Qtà	UM																														
VM2331A0	PERNO M6 FERMA CARTER-SUPP ORTO TEGLIE	4	PZ																														
MT1012A	MOTORE SIMMETRICO 330W 230V ALBERO D12		KMT1012A	KIT MOTORE 330W 230V ALBERO D12	<table border="1"> <thead> <tr> <th>Codice</th> <th>Descrizione</th> <th>Qtà</th> <th>UM</th> </tr> </thead> <tbody> <tr> <td>GN1140A2</td> <td>GUARNIZIONE PORTAMOTO RE STAMPAT</td> <td>1</td> <td>PZ</td> </tr> <tr> <td>MT1012A0</td> <td>MOTORE SIMMETRICO 330W 230V ALBERO D12</td> <td>1</td> <td>PZ</td> </tr> <tr> <td>VI1077A1</td> <td>VITE M6X12 TE INOX</td> <td>1</td> <td>PZ</td> </tr> <tr> <td>VI1521A0</td> <td>RONDELLA PIANA 6X12X1 INOX</td> <td>1</td> <td>PZ</td> </tr> <tr> <td>VM1794A0</td> <td>FASCETTA 250X4.8 PA66 NERA</td> <td>4</td> <td>PZ</td> </tr> <tr> <td>VM2103A0</td> <td>PIASTRINA FERMAFASCE TTA</td> <td>4</td> <td>PZ</td> </tr> </tbody> </table>	Codice	Descrizione	Qtà	UM	GN1140A2	GUARNIZIONE PORTAMOTO RE STAMPAT	1	PZ	MT1012A0	MOTORE SIMMETRICO 330W 230V ALBERO D12	1	PZ	VI1077A1	VITE M6X12 TE INOX	1	PZ	VI1521A0	RONDELLA PIANA 6X12X1 INOX	1	PZ	VM1794A0	FASCETTA 250X4.8 PA66 NERA	4	PZ	VM2103A0	PIASTRINA FERMAFASCE TTA	4	PZ
Codice	Descrizione	Qtà	UM																														
GN1140A2	GUARNIZIONE PORTAMOTO RE STAMPAT	1	PZ																														
MT1012A0	MOTORE SIMMETRICO 330W 230V ALBERO D12	1	PZ																														
VI1077A1	VITE M6X12 TE INOX	1	PZ																														
VI1521A0	RONDELLA PIANA 6X12X1 INOX	1	PZ																														
VM1794A0	FASCETTA 250X4.8 PA66 NERA	4	PZ																														
VM2103A0	PIASTRINA FERMAFASCE TTA	4	PZ																														
0H7170A	PREMI LANA DI VETRO MOTORE M		0H7170A0	PREMI LANA DI VETRO MOTORE M																													
GN1140A	GUARNIZIONE PORTAMOTORE STAMPATO		KGN1140A	KIT 5 PZ.GUARNIZIONE PORTAMOTORE	<table border="1"> <thead> <tr> <th>Codice</th> <th>Descrizione</th> <th>Qtà</th> <th>UM</th> </tr> </thead> <tbody> <tr> <td>GN1140A2</td> <td>GUARNIZIONE PORTAMOTO RE STAMPAT</td> <td>5</td> <td>PZ</td> </tr> </tbody> </table>	Codice	Descrizione	Qtà	UM	GN1140A2	GUARNIZIONE PORTAMOTO RE STAMPAT	5	PZ																				
Codice	Descrizione	Qtà	UM																														
GN1140A2	GUARNIZIONE PORTAMOTO RE STAMPAT	5	PZ																														

COMPONENTE			RICAMBIO																										
Codice	Descrizione	Immagine	Codice	Descrizione	Lista componenti																								
0H4305A	DISCO TENUTA ALBERO MOTORE INOX STP		K0H4305A	KIT DISCO TENUTA 0H4305A	<table border="1"> <thead> <tr> <th>Codice</th> <th>Descrizione</th> <th>Qtà</th> <th>UM</th> </tr> </thead> <tbody> <tr> <td>0H4305A1</td> <td>DISCO TENUTA ALBERO MOTORE INOX STP</td> <td>1</td> <td>PZ</td> </tr> <tr> <td>GN1140A2</td> <td>GUARNIZIONE PORTAMOTO RE STAMPAT</td> <td>1</td> <td>PZ</td> </tr> <tr> <td>SL1045A0</td> <td>SILICONE ANTRACITE S53 80 ML</td> <td>1</td> <td>PZ</td> </tr> <tr> <td>VI1220A1</td> <td>VITE AUTOFILETTA NTE 4.2X11 TCS+ MARUTE</td> <td>3</td> <td>PZ</td> </tr> </tbody> </table>	Codice	Descrizione	Qtà	UM	0H4305A1	DISCO TENUTA ALBERO MOTORE INOX STP	1	PZ	GN1140A2	GUARNIZIONE PORTAMOTO RE STAMPAT	1	PZ	SL1045A0	SILICONE ANTRACITE S53 80 ML	1	PZ	VI1220A1	VITE AUTOFILETTA NTE 4.2X11 TCS+ MARUTE	3	PZ				
Codice	Descrizione	Qtà	UM																										
0H4305A1	DISCO TENUTA ALBERO MOTORE INOX STP	1	PZ																										
GN1140A2	GUARNIZIONE PORTAMOTO RE STAMPAT	1	PZ																										
SL1045A0	SILICONE ANTRACITE S53 80 ML	1	PZ																										
VI1220A1	VITE AUTOFILETTA NTE 4.2X11 TCS+ MARUTE	3	PZ																										
VN1170B	VENTOLA D195 H80 8 PALE DADO M8 + ANELLO		KVN1170B	KIT VENTOLA D195 H80 8 PALE DADO M8+ANEL	<table border="1"> <thead> <tr> <th>Codice</th> <th>Descrizione</th> <th>Qtà</th> <th>UM</th> </tr> </thead> <tbody> <tr> <td>VI1077A1</td> <td>VITE M6X12 TE INOX</td> <td>1</td> <td>PZ</td> </tr> <tr> <td>VI1521A0</td> <td>RONDELLA PIANA 6X12X1 INOX</td> <td>1</td> <td>PZ</td> </tr> <tr> <td>VN1170B0</td> <td>VENTOLA D195 H80 8 PALE DADO M8 + ANELLO</td> <td>1</td> <td>PZ</td> </tr> </tbody> </table>	Codice	Descrizione	Qtà	UM	VI1077A1	VITE M6X12 TE INOX	1	PZ	VI1521A0	RONDELLA PIANA 6X12X1 INOX	1	PZ	VN1170B0	VENTOLA D195 H80 8 PALE DADO M8 + ANELLO	1	PZ								
Codice	Descrizione	Qtà	UM																										
VI1077A1	VITE M6X12 TE INOX	1	PZ																										
VI1521A0	RONDELLA PIANA 6X12X1 INOX	1	PZ																										
VN1170B0	VENTOLA D195 H80 8 PALE DADO M8 + ANELLO	1	PZ																										
GN1085A	GUARNIZIONE RESISTENZA 141X24 G6.25		KG1085A	KIT GUARNIZIONE RESISTENZA GN1085A2	<table border="1"> <thead> <tr> <th>Codice</th> <th>Descrizione</th> <th>Qtà</th> <th>UM</th> </tr> </thead> <tbody> <tr> <td>GN1085A2</td> <td>GUARNIZIONE RESISTENZA 141X24 G6.25</td> <td>1</td> <td>PZ</td> </tr> </tbody> </table>	Codice	Descrizione	Qtà	UM	GN1085A2	GUARNIZIONE RESISTENZA 141X24 G6.25	1	PZ																
Codice	Descrizione	Qtà	UM																										
GN1085A2	GUARNIZIONE RESISTENZA 141X24 G6.25	1	PZ																										
RS1225A	RES. CIRCOLARE 4700W 230V D230 6 SPIRE		KRS1225A	KIT RESISTENZA CIRCOLARE 4.7KW 6 SPIRE	<table border="1"> <thead> <tr> <th>Codice</th> <th>Descrizione</th> <th>Qtà</th> <th>UM</th> </tr> </thead> <tbody> <tr> <td>GN1085A2</td> <td>GUARNIZIONE RESISTENZA 141X24 G6.25</td> <td>1</td> <td>PZ</td> </tr> <tr> <td>RS1225A1</td> <td>RES. CIRCOLARE 4700W 230V D230 6 SPIRE</td> <td>1</td> <td>PZ</td> </tr> <tr> <td>SL1045A0</td> <td>SILICONE ANTRACITE S53 80 ML</td> <td>1</td> <td>PZ</td> </tr> <tr> <td>VI1032A0</td> <td>VITE M4X16 TCB+ INOX</td> <td>1</td> <td>PZ</td> </tr> <tr> <td>VI1075A0</td> <td>DADO M4 H=4 INOX UNI5587</td> <td>1</td> <td>PZ</td> </tr> </tbody> </table>	Codice	Descrizione	Qtà	UM	GN1085A2	GUARNIZIONE RESISTENZA 141X24 G6.25	1	PZ	RS1225A1	RES. CIRCOLARE 4700W 230V D230 6 SPIRE	1	PZ	SL1045A0	SILICONE ANTRACITE S53 80 ML	1	PZ	VI1032A0	VITE M4X16 TCB+ INOX	1	PZ	VI1075A0	DADO M4 H=4 INOX UNI5587	1	PZ
Codice	Descrizione	Qtà	UM																										
GN1085A2	GUARNIZIONE RESISTENZA 141X24 G6.25	1	PZ																										
RS1225A1	RES. CIRCOLARE 4700W 230V D230 6 SPIRE	1	PZ																										
SL1045A0	SILICONE ANTRACITE S53 80 ML	1	PZ																										
VI1032A0	VITE M4X16 TCB+ INOX	1	PZ																										
VI1075A0	DADO M4 H=4 INOX UNI5587	1	PZ																										

COMPONENTE			RICAMBIO																						
Codice	Descrizione	Immagine	Codice	Descrizione	Lista componenti																				
RS1225A	RES. CIRCOLARE 4700W 230V D230 6 SPIRE		KRS1225A	KIT RESISTENZA CIRCOLARE 4.7KW 6 SPIRE	<table border="1"> <thead> <tr> <th>Codice</th> <th>Descrizione</th> <th>Qtà</th> <th>UM</th> </tr> </thead> <tbody> <tr> <td>VI1220A1</td> <td>VITE AUTOFILETTA NTE 4.2X11 TCS+ MARUTE</td> <td>6</td> <td>PZ</td> </tr> <tr> <td>VI1511A0</td> <td>RONDELLA PIANA 4.2X12X1 INOX</td> <td>1</td> <td>PZ</td> </tr> <tr> <td>VM1794A0</td> <td>FASCETTA 250X4.8 PA66 NERA</td> <td>2</td> <td>PZ</td> </tr> <tr> <td>VM2103A0</td> <td>PIASTRINA FERMAFASCE TTA</td> <td>2</td> <td>PZ</td> </tr> </tbody> </table>	Codice	Descrizione	Qtà	UM	VI1220A1	VITE AUTOFILETTA NTE 4.2X11 TCS+ MARUTE	6	PZ	VI1511A0	RONDELLA PIANA 4.2X12X1 INOX	1	PZ	VM1794A0	FASCETTA 250X4.8 PA66 NERA	2	PZ	VM2103A0	PIASTRINA FERMAFASCE TTA	2	PZ
Codice	Descrizione	Qtà	UM																						
VI1220A1	VITE AUTOFILETTA NTE 4.2X11 TCS+ MARUTE	6	PZ																						
VI1511A0	RONDELLA PIANA 4.2X12X1 INOX	1	PZ																						
VM1794A0	FASCETTA 250X4.8 PA66 NERA	2	PZ																						
VM2103A0	PIASTRINA FERMAFASCE TTA	2	PZ																						
OG1593A	DISTANZIALE CARTER XEBC		OG1593A0	DISTANZIALE CARTER XEBC																					
ASM1750A	Assieme generico		ASM1750A0	Assieme generico																					
OG1586A	CARTER ARIA COMPLETO XEBC-06EU-E		OG1586A0	CARTER ARIA COMPLETO XEBC-06EU-E																					
VM2332A	BOCCOLA TUBI UMIDITA		KVM2332A	KIT BOCCOLA TUBI UMIDITA VM2332A0	<table border="1"> <thead> <tr> <th>Codice</th> <th>Descrizione</th> <th>Qtà</th> <th>UM</th> </tr> </thead> <tbody> <tr> <td>VM2332A0</td> <td>BOCCOLA TUBI UMIDITA</td> <td>1</td> <td>PZ</td> </tr> </tbody> </table>	Codice	Descrizione	Qtà	UM	VM2332A0	BOCCOLA TUBI UMIDITA	1	PZ												
Codice	Descrizione	Qtà	UM																						
VM2332A0	BOCCOLA TUBI UMIDITA	1	PZ																						

COMPONENTE			RICAMBIO																						
Codice	Descrizione	Immagine	Codice	Descrizione	Lista componenti																				
VM2251A	DISTRIBUTORE UMIDITA SUPERIOR		KVM2251A	KIT DISTRIBUTORI UMIDITA'	<table border="1"> <thead> <tr> <th>Codice</th> <th>Descrizione</th> <th>Qtà</th> <th>UM</th> </tr> </thead> <tbody> <tr> <td>VM2251A0</td> <td>DISTRIBUTORE UMIDITA SUPERIORE</td> <td>1</td> <td>PZ</td> </tr> <tr> <td>VM2252A0</td> <td>DISTRIBUTORE UMIDITA INFERIORE</td> <td>1</td> <td>PZ</td> </tr> </tbody> </table>	Codice	Descrizione	Qtà	UM	VM2251A0	DISTRIBUTORE UMIDITA SUPERIORE	1	PZ	VM2252A0	DISTRIBUTORE UMIDITA INFERIORE	1	PZ								
Codice	Descrizione	Qtà	UM																						
VM2251A0	DISTRIBUTORE UMIDITA SUPERIORE	1	PZ																						
VM2252A0	DISTRIBUTORE UMIDITA INFERIORE	1	PZ																						
VM2252A	DISTRIBUTORE UMIDITA INFERIORE		KVM2252A	KIT DISTRIBUTORE UMIDITA' INFERIOR	<table border="1"> <thead> <tr> <th>Codice</th> <th>Descrizione</th> <th>Qtà</th> <th>UM</th> </tr> </thead> <tbody> <tr> <td>VM2252A0</td> <td>DISTRIBUTORE UMIDITA INFERIORE</td> <td>1</td> <td>PZ</td> </tr> </tbody> </table>	Codice	Descrizione	Qtà	UM	VM2252A0	DISTRIBUTORE UMIDITA INFERIORE	1	PZ												
Codice	Descrizione	Qtà	UM																						
VM2252A0	DISTRIBUTORE UMIDITA INFERIORE	1	PZ																						
			KVM2251A	KIT DISTRIBUTORI UMIDITA'	<table border="1"> <thead> <tr> <th>Codice</th> <th>Descrizione</th> <th>Qtà</th> <th>UM</th> </tr> </thead> <tbody> <tr> <td>VM2251A0</td> <td>DISTRIBUTORE UMIDITA SUPERIORE</td> <td>1</td> <td>PZ</td> </tr> <tr> <td>VM2252A0</td> <td>DISTRIBUTORE UMIDITA INFERIORE</td> <td>1</td> <td>PZ</td> </tr> </tbody> </table>	Codice	Descrizione	Qtà	UM	VM2251A0	DISTRIBUTORE UMIDITA SUPERIORE	1	PZ	VM2252A0	DISTRIBUTORE UMIDITA INFERIORE	1	PZ								
Codice	Descrizione	Qtà	UM																						
VM2251A0	DISTRIBUTORE UMIDITA SUPERIORE	1	PZ																						
VM2252A0	DISTRIBUTORE UMIDITA INFERIORE	1	PZ																						
TB2980A	ASM TUBO UMIDITA 2 VIE XEBC-06EU-E		TB2980A0	ASM TUBO UMIDITA 2 VIE XEBC-06EU-E																					
GN1567A	GN1006A-GUARNIZI ONE PORTA XEBC-06XX		KG1567A	KIT GUARNIZIONE PORTA XEBC-06XX	<table border="1"> <thead> <tr> <th>Codice</th> <th>Descrizione</th> <th>Qtà</th> <th>UM</th> </tr> </thead> <tbody> <tr> <td>GN1006A1</td> <td>GUARNIZIONE FACCIATA PORTA BANDIERA</td> <td>2.480</td> <td>M</td> </tr> <tr> <td>GN1008A0</td> <td>GUARNIZIONE INTERNA PER GIUNZIONE GN1006</td> <td>0.030</td> <td>M</td> </tr> <tr> <td>SL1025A0</td> <td>TUBETTO SIL.90ML DOW CORNING 734 CLEAR</td> <td>0.012</td> <td>PZ</td> </tr> <tr> <td>VM2277A0</td> <td>SPINA KIT GUARNIZIONE PORTA</td> <td>1</td> <td>PZ</td> </tr> </tbody> </table>	Codice	Descrizione	Qtà	UM	GN1006A1	GUARNIZIONE FACCIATA PORTA BANDIERA	2.480	M	GN1008A0	GUARNIZIONE INTERNA PER GIUNZIONE GN1006	0.030	M	SL1025A0	TUBETTO SIL.90ML DOW CORNING 734 CLEAR	0.012	PZ	VM2277A0	SPINA KIT GUARNIZIONE PORTA	1	PZ
Codice	Descrizione	Qtà	UM																						
GN1006A1	GUARNIZIONE FACCIATA PORTA BANDIERA	2.480	M																						
GN1008A0	GUARNIZIONE INTERNA PER GIUNZIONE GN1006	0.030	M																						
SL1025A0	TUBETTO SIL.90ML DOW CORNING 734 CLEAR	0.012	PZ																						
VM2277A0	SPINA KIT GUARNIZIONE PORTA	1	PZ																						

COMPONENTE			RICAMBIO																																		
Codice	Descrizione	Immagine	Codice	Descrizione	Lista componenti																																
TB2902A	TUBO CAMINO CAMERA D 50 FORNI GAS		TB2902A0	TUBO CAMINO CAMERA D 50 FORNI GAS																																	
GRL1405A	SUPPORTO LAT. SX 6X600X400		KGRL1405A	KIT SUPPORTI LATERALI 6TG 600X400 MM	<table border="1"> <thead> <tr> <th>Codice</th> <th>Descrizione</th> <th>Qtà</th> <th>UM</th> </tr> </thead> <tbody> <tr> <td>0H4215A0</td> <td>PROFILO GUIDA TEGLIE PAST.L372.5 B</td> <td>12</td> <td>PZ</td> </tr> <tr> <td>0H4420A0</td> <td>PIASTRINA SUPPORTO SONDA AL CUORE H35</td> <td>1</td> <td>PZ</td> </tr> <tr> <td>0H7302A0</td> <td>PROFILO PIANO PER SUPP 0H7312 0H7313</td> <td>2</td> <td>PZ</td> </tr> <tr> <td>0H7303A0</td> <td>PROFILO PIANO PER SUPP 0H7314 0H7315</td> <td>2</td> <td>PZ</td> </tr> <tr> <td>IP1508A1</td> <td>POLISTIROLO PROFILO AD U 2000X60X60</td> <td>1.200</td> <td>M</td> </tr> <tr> <td>VM1058A1</td> <td>FILM TERMORETRA IBILE H410</td> <td>1.500</td> <td>M</td> </tr> <tr> <td>VM1059A1</td> <td>FILM TERMORETRA IBILE H800</td> <td>1.500</td> <td>M</td> </tr> </tbody> </table>	Codice	Descrizione	Qtà	UM	0H4215A0	PROFILO GUIDA TEGLIE PAST.L372.5 B	12	PZ	0H4420A0	PIASTRINA SUPPORTO SONDA AL CUORE H35	1	PZ	0H7302A0	PROFILO PIANO PER SUPP 0H7312 0H7313	2	PZ	0H7303A0	PROFILO PIANO PER SUPP 0H7314 0H7315	2	PZ	IP1508A1	POLISTIROLO PROFILO AD U 2000X60X60	1.200	M	VM1058A1	FILM TERMORETRA IBILE H410	1.500	M	VM1059A1	FILM TERMORETRA IBILE H800	1.500	M
Codice	Descrizione	Qtà	UM																																		
0H4215A0	PROFILO GUIDA TEGLIE PAST.L372.5 B	12	PZ																																		
0H4420A0	PIASTRINA SUPPORTO SONDA AL CUORE H35	1	PZ																																		
0H7302A0	PROFILO PIANO PER SUPP 0H7312 0H7313	2	PZ																																		
0H7303A0	PROFILO PIANO PER SUPP 0H7314 0H7315	2	PZ																																		
IP1508A1	POLISTIROLO PROFILO AD U 2000X60X60	1.200	M																																		
VM1058A1	FILM TERMORETRA IBILE H410	1.500	M																																		
VM1059A1	FILM TERMORETRA IBILE H800	1.500	M																																		
GRL1406A	SUPPORTO LAT. DX 6X600X400		KGRL1405A	KIT SUPPORTI LATERALI 6TG 600X400 MM	<table border="1"> <thead> <tr> <th>Codice</th> <th>Descrizione</th> <th>Qtà</th> <th>UM</th> </tr> </thead> <tbody> <tr> <td>0H4215A0</td> <td>PROFILO GUIDA TEGLIE PAST.L372.5 B</td> <td>12</td> <td>PZ</td> </tr> <tr> <td>0H4420A0</td> <td>PIASTRINA SUPPORTO SONDA AL CUORE H35</td> <td>1</td> <td>PZ</td> </tr> <tr> <td>0H7302A0</td> <td>PROFILO PIANO PER SUPP 0H7312 0H7313</td> <td>2</td> <td>PZ</td> </tr> <tr> <td>0H7303A0</td> <td>PROFILO PIANO PER SUPP 0H7314 0H7315</td> <td>2</td> <td>PZ</td> </tr> <tr> <td>IP1508A1</td> <td>POLISTIROLO PROFILO AD U 2000X60X60</td> <td>1.200</td> <td>M</td> </tr> </tbody> </table>	Codice	Descrizione	Qtà	UM	0H4215A0	PROFILO GUIDA TEGLIE PAST.L372.5 B	12	PZ	0H4420A0	PIASTRINA SUPPORTO SONDA AL CUORE H35	1	PZ	0H7302A0	PROFILO PIANO PER SUPP 0H7312 0H7313	2	PZ	0H7303A0	PROFILO PIANO PER SUPP 0H7314 0H7315	2	PZ	IP1508A1	POLISTIROLO PROFILO AD U 2000X60X60	1.200	M								
Codice	Descrizione	Qtà	UM																																		
0H4215A0	PROFILO GUIDA TEGLIE PAST.L372.5 B	12	PZ																																		
0H4420A0	PIASTRINA SUPPORTO SONDA AL CUORE H35	1	PZ																																		
0H7302A0	PROFILO PIANO PER SUPP 0H7312 0H7313	2	PZ																																		
0H7303A0	PROFILO PIANO PER SUPP 0H7314 0H7315	2	PZ																																		
IP1508A1	POLISTIROLO PROFILO AD U 2000X60X60	1.200	M																																		

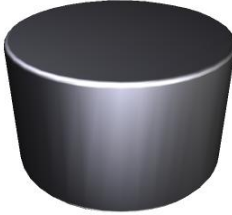
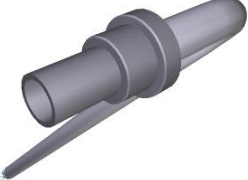
COMPONENTE			RICAMBIO																						
Codice	Descrizione	Immagine	Codice	Descrizione	Lista componenti																				
GRL1406A	SUPPORTO LAT. DX 6X600X400		KGRL1405A	KIT SUPPORTI LATERALI 6TG 600X400 MM	<table border="1"> <thead> <tr> <th>Codice</th> <th>Descrizione</th> <th>Qtà</th> <th>UM</th> </tr> </thead> <tbody> <tr> <td>VM1058A1</td> <td>FILM TERMORETRA IBILE H410</td> <td>1.500</td> <td>M</td> </tr> <tr> <td>VM1059A1</td> <td>FILM TERMORETRA IBILE H800</td> <td>1.500</td> <td>M</td> </tr> </tbody> </table>	Codice	Descrizione	Qtà	UM	VM1058A1	FILM TERMORETRA IBILE H410	1.500	M	VM1059A1	FILM TERMORETRA IBILE H800	1.500	M								
Codice	Descrizione	Qtà	UM																						
VM1058A1	FILM TERMORETRA IBILE H410	1.500	M																						
VM1059A1	FILM TERMORETRA IBILE H800	1.500	M																						
0H2730A	STAFFA ZINCATA SOSTEGNO MUFFOLA																								
PE1710B	SENSORE GIRI E VERSO ROTAZIONE MOTORE		KPE1710B	KIT SENSORE NUMERO GIRI MOTORE	<table border="1"> <thead> <tr> <th>Codice</th> <th>Descrizione</th> <th>Qtà</th> <th>UM</th> </tr> </thead> <tbody> <tr> <td>PE1710B0</td> <td>SENSORE GIRI E VERSO ROTAZIONE MOTORE</td> <td>1</td> <td>PZ</td> </tr> <tr> <td>VE1550A0</td> <td>MAGNETE NEODIMIO 5X3 MM</td> <td>1</td> <td>PZ</td> </tr> <tr> <td>VI1966A0</td> <td>VITE M4X14 TSP+ ZN</td> <td>1</td> <td>PZ</td> </tr> <tr> <td>VM1635A0</td> <td>DISCO SUPPORTO MAGNETE</td> <td>1</td> <td>PZ</td> </tr> </tbody> </table>	Codice	Descrizione	Qtà	UM	PE1710B0	SENSORE GIRI E VERSO ROTAZIONE MOTORE	1	PZ	VE1550A0	MAGNETE NEODIMIO 5X3 MM	1	PZ	VI1966A0	VITE M4X14 TSP+ ZN	1	PZ	VM1635A0	DISCO SUPPORTO MAGNETE	1	PZ
Codice	Descrizione	Qtà	UM																						
PE1710B0	SENSORE GIRI E VERSO ROTAZIONE MOTORE	1	PZ																						
VE1550A0	MAGNETE NEODIMIO 5X3 MM	1	PZ																						
VI1966A0	VITE M4X14 TSP+ ZN	1	PZ																						
VM1635A0	DISCO SUPPORTO MAGNETE	1	PZ																						
VE1550A	MAGNETE NEODIMIO 5X3 MM		VE1550A0	MAGNETE NEODIMIO 5X3 MM																					
TB2937B	TUBO EST UMIDITA' D10 CON RACCORDO XEBC		TB2937B0	TUBO EST UMIDITA' D10 CON RACCORDO XEBC																					

ASM1771A/0.D04 - Copertura esterna

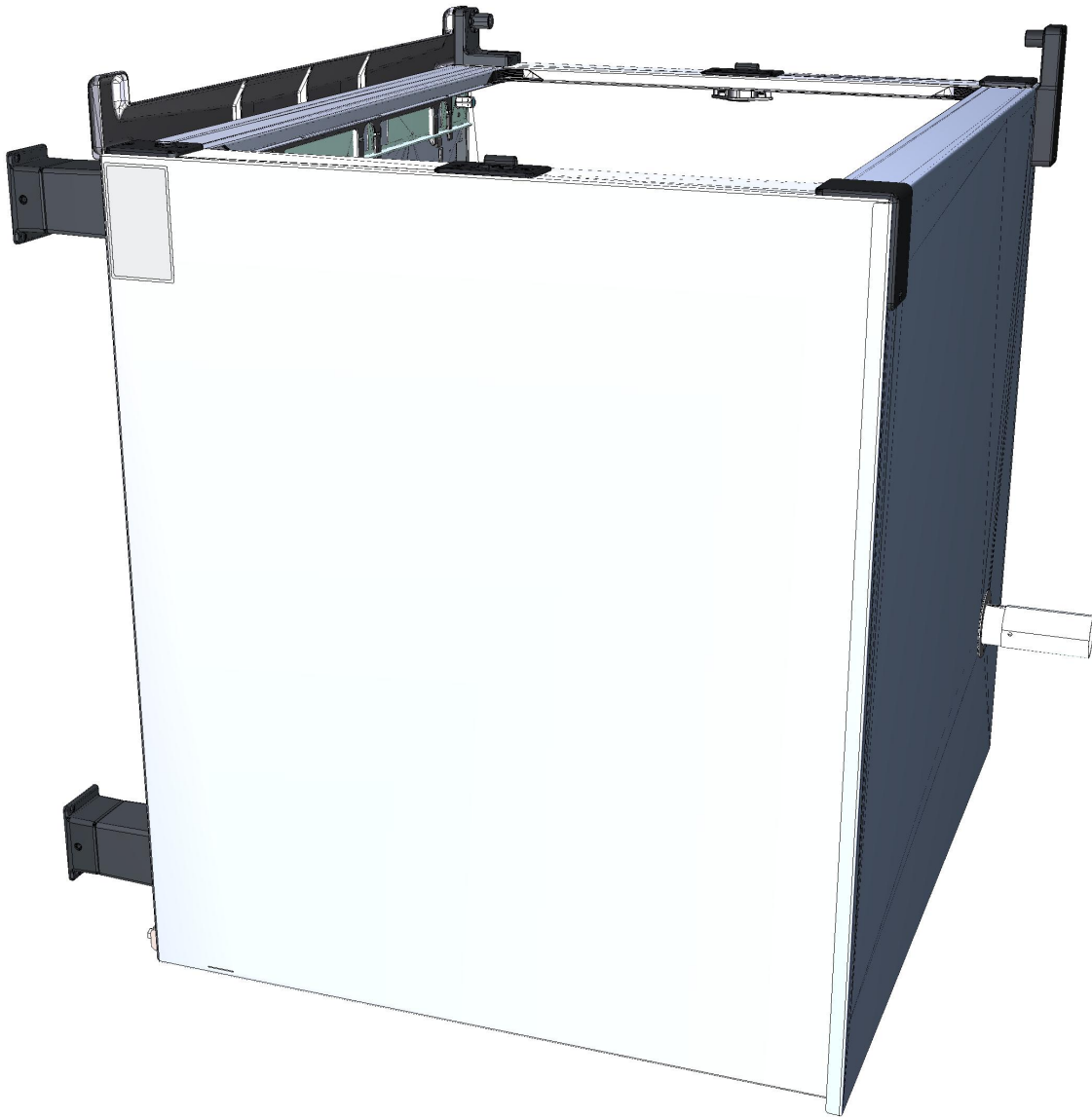

FRONTE





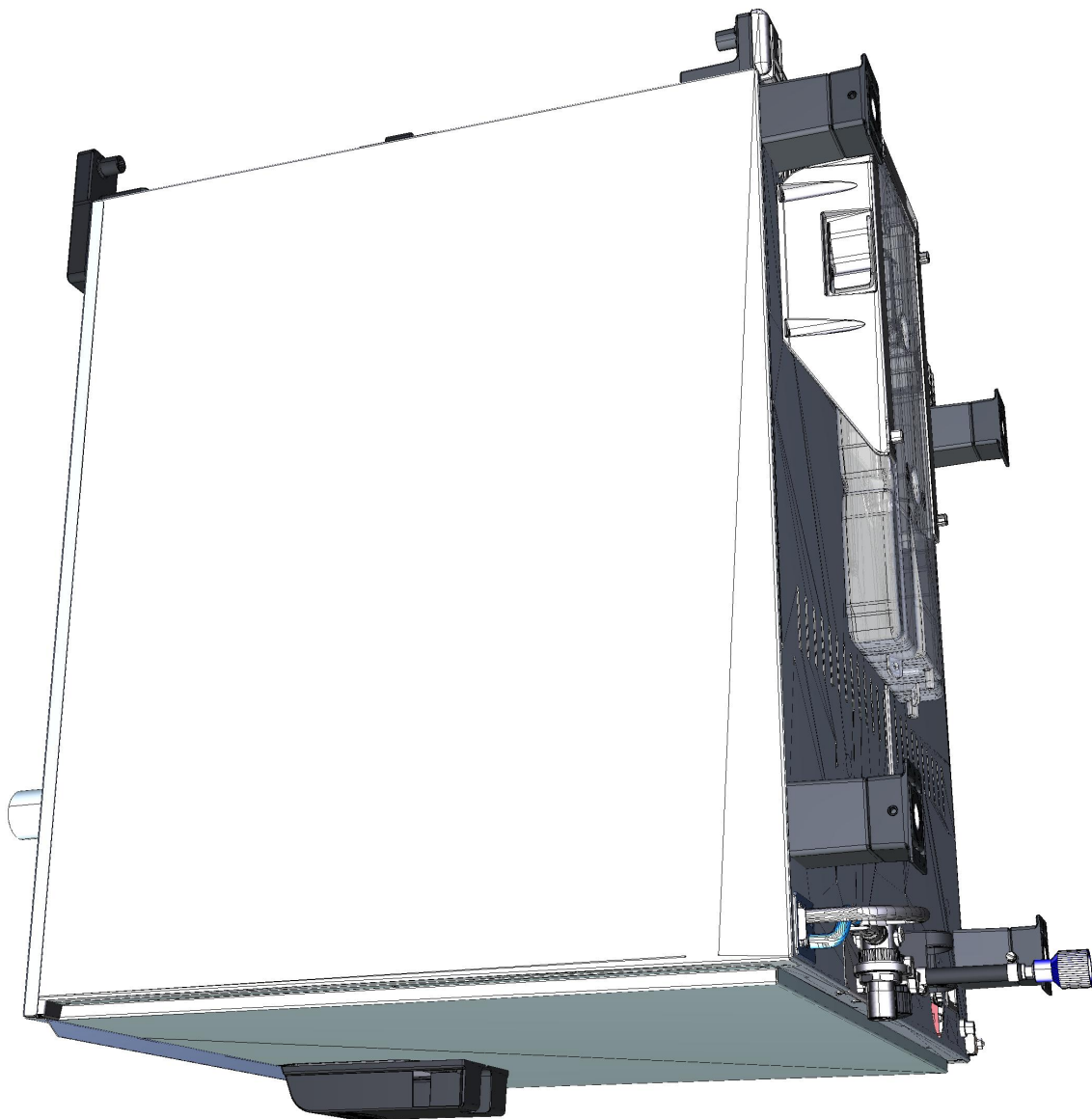

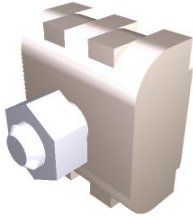
ASM1771A/0.D04 - Copertura esterna

RETRO





COMPONENTE			RICAMBIO																										
Codice	Descrizione	Immagine	Codice	Descrizione	Lista componenti																								
TR1136A	TERMOSTATO SIC. UNIP. 330°C		KTR1136A	KIT TERMOSTATO SICUREZZA 330°C	<table border="1"> <thead> <tr> <th>Codice</th> <th>Descrizione</th> <th>Qtà</th> <th>UM</th> </tr> </thead> <tbody> <tr> <td>0H7030A0</td> <td>COPERCHIO INGRESSO BULBO</td> <td>1</td> <td>PZ</td> </tr> <tr> <td>GN1531A0</td> <td>GUARNIZIONE TENUTA INGRESSO BULBO</td> <td>1</td> <td>PZ</td> </tr> <tr> <td>SL1045A0</td> <td>SILICONE ANTRACITE S53 80 ML</td> <td>1</td> <td>PZ</td> </tr> <tr> <td>TR1136A0</td> <td>TERMOSTATO SIC. UNIP. 330°C</td> <td>1</td> <td>PZ</td> </tr> <tr> <td>VI1220A1</td> <td>VITE AUTOFILETTA NTE 4.2X11 TCS+ MARUTE</td> <td>3</td> <td>PZ</td> </tr> </tbody> </table>	Codice	Descrizione	Qtà	UM	0H7030A0	COPERCHIO INGRESSO BULBO	1	PZ	GN1531A0	GUARNIZIONE TENUTA INGRESSO BULBO	1	PZ	SL1045A0	SILICONE ANTRACITE S53 80 ML	1	PZ	TR1136A0	TERMOSTATO SIC. UNIP. 330°C	1	PZ	VI1220A1	VITE AUTOFILETTA NTE 4.2X11 TCS+ MARUTE	3	PZ
Codice	Descrizione	Qtà	UM																										
0H7030A0	COPERCHIO INGRESSO BULBO	1	PZ																										
GN1531A0	GUARNIZIONE TENUTA INGRESSO BULBO	1	PZ																										
SL1045A0	SILICONE ANTRACITE S53 80 ML	1	PZ																										
TR1136A0	TERMOSTATO SIC. UNIP. 330°C	1	PZ																										
VI1220A1	VITE AUTOFILETTA NTE 4.2X11 TCS+ MARUTE	3	PZ																										
VM1750A	MORSETTO A PETTINE		KVM1750A	KIT MORSETTIERA A PETTINE	<table border="1"> <thead> <tr> <th>Codice</th> <th>Descrizione</th> <th>Qtà</th> <th>UM</th> </tr> </thead> <tbody> <tr> <td>VM1750A0</td> <td>MORSETTO A PETTINE</td> <td>1</td> <td>PZ</td> </tr> </tbody> </table>	Codice	Descrizione	Qtà	UM	VM1750A0	MORSETTO A PETTINE	1	PZ																
Codice	Descrizione	Qtà	UM																										
VM1750A0	MORSETTO A PETTINE	1	PZ																										
VM2074A	CLIP CON VITE PER SUPPORTO CASSETTO		KVM1220A	KIT 4 PZ.CLIP SUPPORTO CASSETTI CT BT	<table border="1"> <thead> <tr> <th>Codice</th> <th>Descrizione</th> <th>Qtà</th> <th>UM</th> </tr> </thead> <tbody> <tr> <td>VI1220A1</td> <td>VITE AUTOFILETTA NTE 4.2X11 TCS+ MARUTE</td> <td>4</td> <td>PZ</td> </tr> <tr> <td>VM1220A0</td> <td>CLIP FISSAGGIO CASSETTO RACCOGLIGO CCE</td> <td>4</td> <td>PZ</td> </tr> <tr> <td>VM2074A0</td> <td>CLIP CON VITE PER SUPPORTO CASSETTO</td> <td>4</td> <td>PZ</td> </tr> </tbody> </table>	Codice	Descrizione	Qtà	UM	VI1220A1	VITE AUTOFILETTA NTE 4.2X11 TCS+ MARUTE	4	PZ	VM1220A0	CLIP FISSAGGIO CASSETTO RACCOGLIGO CCE	4	PZ	VM2074A0	CLIP CON VITE PER SUPPORTO CASSETTO	4	PZ								
Codice	Descrizione	Qtà	UM																										
VI1220A1	VITE AUTOFILETTA NTE 4.2X11 TCS+ MARUTE	4	PZ																										
VM1220A0	CLIP FISSAGGIO CASSETTO RACCOGLIGO CCE	4	PZ																										
VM2074A0	CLIP CON VITE PER SUPPORTO CASSETTO	4	PZ																										
VN1165A	VENTOLA RAFFREDDAMENTO 230VAC 50/60HZ 12		KVN1165A	KIT VENTOLA RAFFREDDAMENTO 120X120 230V	<table border="1"> <thead> <tr> <th>Codice</th> <th>Descrizione</th> <th>Qtà</th> <th>UM</th> </tr> </thead> <tbody> <tr> <td>VI1099A0</td> <td>VITE AUTOFORANT E 4.8X13 TCB+ ZN</td> <td>4</td> <td>PZ</td> </tr> <tr> <td>VM1555A2</td> <td>SUPPORTO VENTOLA RAFFREDDAM ENTO CT BT</td> <td>1</td> <td>PZ</td> </tr> <tr> <td>VN1165A0</td> <td>VENTOLA RAFFREDDAM ENTO 230VAC 50/60HZ 12</td> <td>1</td> <td>PZ</td> </tr> </tbody> </table>	Codice	Descrizione	Qtà	UM	VI1099A0	VITE AUTOFORANT E 4.8X13 TCB+ ZN	4	PZ	VM1555A2	SUPPORTO VENTOLA RAFFREDDAM ENTO CT BT	1	PZ	VN1165A0	VENTOLA RAFFREDDAM ENTO 230VAC 50/60HZ 12	1	PZ								
Codice	Descrizione	Qtà	UM																										
VI1099A0	VITE AUTOFORANT E 4.8X13 TCB+ ZN	4	PZ																										
VM1555A2	SUPPORTO VENTOLA RAFFREDDAM ENTO CT BT	1	PZ																										
VN1165A0	VENTOLA RAFFREDDAM ENTO 230VAC 50/60HZ 12	1	PZ																										



COMPONENTE			RICAMBIO																		
Codice	Descrizione	Immagine	Codice	Descrizione	Lista componenti																
VM1556A	PROTEZIONE VENTOLA RAFFREDDAMENTO CT BT		KVM1556A	KIT PROTEZIONE VENTOLA RAFFREDDAMENTO	<table border="1"> <thead> <tr> <th>Codice</th> <th>Descrizione</th> <th>Qtà</th> <th>UM</th> </tr> </thead> <tbody> <tr> <td>VM1556A0</td> <td>PROTEZIONE VENTOLA RAFFREDDAMENTO CT BT</td> <td>1</td> <td>PZ</td> </tr> </tbody> </table>	Codice	Descrizione	Qtà	UM	VM1556A0	PROTEZIONE VENTOLA RAFFREDDAMENTO CT BT	1	PZ								
Codice	Descrizione	Qtà	UM																		
VM1556A0	PROTEZIONE VENTOLA RAFFREDDAMENTO CT BT	1	PZ																		
VM1555A	SUPPORTO VENTOLA RAFFREDDAMENTO CT BT																				
VL1026A	CURVA PER TUBO DI SCARICO		KVL1026A	KIT CURVA PER TUBO DI SCARICO	<table border="1"> <thead> <tr> <th>Codice</th> <th>Descrizione</th> <th>Qtà</th> <th>UM</th> </tr> </thead> <tbody> <tr> <td>GN1400A0</td> <td>GUARNIZIONE SIFONE</td> <td>1</td> <td>PZ</td> </tr> <tr> <td>VL1026A0</td> <td>CURVA PER TUBO DI SCARICO</td> <td>1</td> <td>PZ</td> </tr> <tr> <td>VM2039A0</td> <td>ANELLO FISSAGGIO CURVA DI SCARICO</td> <td>1</td> <td>PZ</td> </tr> </tbody> </table>	Codice	Descrizione	Qtà	UM	GN1400A0	GUARNIZIONE SIFONE	1	PZ	VL1026A0	CURVA PER TUBO DI SCARICO	1	PZ	VM2039A0	ANELLO FISSAGGIO CURVA DI SCARICO	1	PZ
Codice	Descrizione	Qtà	UM																		
GN1400A0	GUARNIZIONE SIFONE	1	PZ																		
VL1026A0	CURVA PER TUBO DI SCARICO	1	PZ																		
VM2039A0	ANELLO FISSAGGIO CURVA DI SCARICO	1	PZ																		
VM2039A	ANELLO FISSAGGIO CURVA DI SCARICO		KVL1026A	KIT CURVA PER TUBO DI SCARICO	<table border="1"> <thead> <tr> <th>Codice</th> <th>Descrizione</th> <th>Qtà</th> <th>UM</th> </tr> </thead> <tbody> <tr> <td>GN1400A0</td> <td>GUARNIZIONE SIFONE</td> <td>1</td> <td>PZ</td> </tr> <tr> <td>VL1026A0</td> <td>CURVA PER TUBO DI SCARICO</td> <td>1</td> <td>PZ</td> </tr> <tr> <td>VM2039A0</td> <td>ANELLO FISSAGGIO CURVA DI SCARICO</td> <td>1</td> <td>PZ</td> </tr> </tbody> </table>	Codice	Descrizione	Qtà	UM	GN1400A0	GUARNIZIONE SIFONE	1	PZ	VL1026A0	CURVA PER TUBO DI SCARICO	1	PZ	VM2039A0	ANELLO FISSAGGIO CURVA DI SCARICO	1	PZ
Codice	Descrizione	Qtà	UM																		
GN1400A0	GUARNIZIONE SIFONE	1	PZ																		
VL1026A0	CURVA PER TUBO DI SCARICO	1	PZ																		
VM2039A0	ANELLO FISSAGGIO CURVA DI SCARICO	1	PZ																		
VM2249A	ANGOLO FACCIATA MUFFOLA PPS		KVM2249A	KIT ANGOLO FACCIATA MUFFOLA	<table border="1"> <thead> <tr> <th>Codice</th> <th>Descrizione</th> <th>Qtà</th> <th>UM</th> </tr> </thead> <tbody> <tr> <td>VM2249A0</td> <td>ANGOLO FACCIATA MUFFOLA PPS</td> <td>1</td> <td>PZ</td> </tr> </tbody> </table>	Codice	Descrizione	Qtà	UM	VM2249A0	ANGOLO FACCIATA MUFFOLA PPS	1	PZ								
Codice	Descrizione	Qtà	UM																		
VM2249A0	ANGOLO FACCIATA MUFFOLA PPS	1	PZ																		

COMPONENTE			RICAMBIO																																		
Codice	Descrizione	Immagine	Codice	Descrizione	Lista componenti																																
0H2561A	CONTROSTAFFA PORTA MM		0H2561A0	CONTROSTAFFA PORTA MM																																	
VM1240A	TAPPO NYLON SUPPORTO CONTROSTAFFA		KVM1240A	KIT TAPPO SUPPORTO CONTROSTAFFA 4P	<table border="1"> <thead> <tr> <th>Codice</th> <th>Descrizione</th> <th>Qtà</th> <th>UM</th> </tr> </thead> <tbody> <tr> <td>VM1240A0</td> <td>TAPPO NYLON SUPPORTO CONTROSTAFFA</td> <td>4</td> <td>PZ</td> </tr> </tbody> </table>	Codice	Descrizione	Qtà	UM	VM1240A0	TAPPO NYLON SUPPORTO CONTROSTAFFA	4	PZ																								
Codice	Descrizione	Qtà	UM																																		
VM1240A0	TAPPO NYLON SUPPORTO CONTROSTAFFA	4	PZ																																		
VM2282A	PIASTRINA SUPPORTO MICROPORTA		KVM2282A	KIT PIASTRINA SUPPORTO MICROPORTA	<table border="1"> <thead> <tr> <th>Codice</th> <th>Descrizione</th> <th>Qtà</th> <th>UM</th> </tr> </thead> <tbody> <tr> <td>VM2282A0</td> <td>PIASTRINA SUPPORTO MICROPORTA</td> <td>1</td> <td>PZ</td> </tr> </tbody> </table>	Codice	Descrizione	Qtà	UM	VM2282A0	PIASTRINA SUPPORTO MICROPORTA	1	PZ																								
Codice	Descrizione	Qtà	UM																																		
VM2282A0	PIASTRINA SUPPORTO MICROPORTA	1	PZ																																		
VE1020B	MICROINT. PORTA MAGNETICO CON MINIFIT 2P		KVE1020B	KIT MICROPORTA	<table border="1"> <thead> <tr> <th>Codice</th> <th>Descrizione</th> <th>Qtà</th> <th>UM</th> </tr> </thead> <tbody> <tr> <td>CE1030A0</td> <td>FASTON FEMMINA 6.3X0.8 0.5-1MMQ</td> <td>2</td> <td>PZ</td> </tr> <tr> <td>CE1660A0</td> <td>COPRI FASTON FEMMINA 6.3X0.8</td> <td>2</td> <td>PZ</td> </tr> <tr> <td>CE1730A0</td> <td>CAVO PVC NP 2 X AWG22 STYLE 2095</td> <td>0.150</td> <td>M</td> </tr> <tr> <td>CE1740A0</td> <td>TERMINALE MINIFIT MASCHIO</td> <td>2</td> <td>PZ</td> </tr> <tr> <td>CE1745A0</td> <td>CONNETTORE MINIFIT FEMMINA 2 VI</td> <td>1</td> <td>PZ</td> </tr> <tr> <td>VE1020B0</td> <td>MICROINT. PORTA MAGNETICO CON MINIFIT 2</td> <td>1</td> <td>PZ</td> </tr> <tr> <td>VE1030A1</td> <td>CALAMITA D=22,9MM PER MICROPORTA</td> <td>1</td> <td>PZ</td> </tr> </tbody> </table>	Codice	Descrizione	Qtà	UM	CE1030A0	FASTON FEMMINA 6.3X0.8 0.5-1MMQ	2	PZ	CE1660A0	COPRI FASTON FEMMINA 6.3X0.8	2	PZ	CE1730A0	CAVO PVC NP 2 X AWG22 STYLE 2095	0.150	M	CE1740A0	TERMINALE MINIFIT MASCHIO	2	PZ	CE1745A0	CONNETTORE MINIFIT FEMMINA 2 VI	1	PZ	VE1020B0	MICROINT. PORTA MAGNETICO CON MINIFIT 2	1	PZ	VE1030A1	CALAMITA D=22,9MM PER MICROPORTA	1	PZ
Codice	Descrizione	Qtà	UM																																		
CE1030A0	FASTON FEMMINA 6.3X0.8 0.5-1MMQ	2	PZ																																		
CE1660A0	COPRI FASTON FEMMINA 6.3X0.8	2	PZ																																		
CE1730A0	CAVO PVC NP 2 X AWG22 STYLE 2095	0.150	M																																		
CE1740A0	TERMINALE MINIFIT MASCHIO	2	PZ																																		
CE1745A0	CONNETTORE MINIFIT FEMMINA 2 VI	1	PZ																																		
VE1020B0	MICROINT. PORTA MAGNETICO CON MINIFIT 2	1	PZ																																		
VE1030A1	CALAMITA D=22,9MM PER MICROPORTA	1	PZ																																		

COMPONENTE			RICAMBIO																										
Codice	Descrizione	Immagine	Codice	Descrizione	Lista componenti																								
VM2035A	SUPPORTO PER TUBO DI SCARICO		KVM2035A	KIT 2 PZ SUPPORTO PER TUBO DI SCARICO	<table border="1"> <thead> <tr> <th>Codice</th> <th>Descrizione</th> <th>Qtà</th> <th>UM</th> </tr> </thead> <tbody> <tr> <td>VM2035A0</td> <td>SUPPORTO PER TUBO DI SCARICO</td> <td>2</td> <td>PZ</td> </tr> </tbody> </table>	Codice	Descrizione	Qtà	UM	VM2035A0	SUPPORTO PER TUBO DI SCARICO	2	PZ																
Codice	Descrizione	Qtà	UM																										
VM2035A0	SUPPORTO PER TUBO DI SCARICO	2	PZ																										
VM1190A	SCROCCO MANIGLIA DX CT BT		KVM1190A	KIT SCROCCO MANIGLIA DX CT BT	<table border="1"> <thead> <tr> <th>Codice</th> <th>Descrizione</th> <th>Qtà</th> <th>UM</th> </tr> </thead> <tbody> <tr> <td>VI0239A1</td> <td>VITE AUTOFIL. 4.2X25 TCB+ INOX</td> <td>2</td> <td>PZ</td> </tr> <tr> <td>VI1220A1</td> <td>VITE AUTOFILETTA NTE 4.2X11 TCS+ MARUTE</td> <td>2</td> <td>PZ</td> </tr> <tr> <td>VM1190A2</td> <td>SCROCCO MANIGLIA DX CT BT</td> <td>1</td> <td>PZ</td> </tr> <tr> <td>VM1192A1</td> <td>COPERCHIO POST. SCROCCO MANIGLIA CT BT</td> <td>1</td> <td>PZ</td> </tr> <tr> <td>VM1460A0</td> <td>COPERCHIO DX SCROCCO PORTA XBC/XVC</td> <td>1</td> <td>PZ</td> </tr> </tbody> </table>	Codice	Descrizione	Qtà	UM	VI0239A1	VITE AUTOFIL. 4.2X25 TCB+ INOX	2	PZ	VI1220A1	VITE AUTOFILETTA NTE 4.2X11 TCS+ MARUTE	2	PZ	VM1190A2	SCROCCO MANIGLIA DX CT BT	1	PZ	VM1192A1	COPERCHIO POST. SCROCCO MANIGLIA CT BT	1	PZ	VM1460A0	COPERCHIO DX SCROCCO PORTA XBC/XVC	1	PZ
Codice	Descrizione	Qtà	UM																										
VI0239A1	VITE AUTOFIL. 4.2X25 TCB+ INOX	2	PZ																										
VI1220A1	VITE AUTOFILETTA NTE 4.2X11 TCS+ MARUTE	2	PZ																										
VM1190A2	SCROCCO MANIGLIA DX CT BT	1	PZ																										
VM1192A1	COPERCHIO POST. SCROCCO MANIGLIA CT BT	1	PZ																										
VM1460A0	COPERCHIO DX SCROCCO PORTA XBC/XVC	1	PZ																										
VM1811A	TAPPO TENUTA ACQUA SX		VM1811A0	TAPPO TENUTA ACQUA SX																									
VM2280A	PIASTRINA COPRI SCROCCO		KVM2280A	KIT PIASTRINA COPRI SCROCCO VM2280A	<table border="1"> <thead> <tr> <th>Codice</th> <th>Descrizione</th> <th>Qtà</th> <th>UM</th> </tr> </thead> <tbody> <tr> <td>VM2280A0</td> <td>PIASTRINA COPRI SCROCCO</td> <td>1</td> <td>PZ</td> </tr> </tbody> </table>	Codice	Descrizione	Qtà	UM	VM2280A0	PIASTRINA COPRI SCROCCO	1	PZ																
Codice	Descrizione	Qtà	UM																										
VM2280A0	PIASTRINA COPRI SCROCCO	1	PZ																										

COMPONENTE			RICAMBIO														
Codice	Descrizione	Immagine	Codice	Descrizione	Lista componenti												
VM2281A	PIASTRINA COPRI FORI		KVM2281A	KIT PIASTRINA COPRI FORI VM2281A0	<table border="1"> <thead> <tr> <th>Codice</th> <th>Descrizione</th> <th>Qtà</th> <th>UM</th> </tr> </thead> <tbody> <tr> <td>VM2281A0</td> <td>PIASTRINA COPRI FORI</td> <td>1</td> <td>PZ</td> </tr> </tbody> </table>	Codice	Descrizione	Qtà	UM	VM2281A0	PIASTRINA COPRI FORI	1	PZ				
Codice	Descrizione	Qtà	UM														
VM2281A0	PIASTRINA COPRI FORI	1	PZ														
VM2311A	PIASTRINA COPRI VITI		KVM2311A	KIT PIASTRINA COPRIVITI VM2311A	<table border="1"> <thead> <tr> <th>Codice</th> <th>Descrizione</th> <th>Qtà</th> <th>UM</th> </tr> </thead> <tbody> <tr> <td>VM2311A0</td> <td>PIASTRINA COPRI VITI</td> <td>1</td> <td>PZ</td> </tr> </tbody> </table>	Codice	Descrizione	Qtà	UM	VM2311A0	PIASTRINA COPRI VITI	1	PZ				
Codice	Descrizione	Qtà	UM														
VM2311A0	PIASTRINA COPRI VITI	1	PZ														
GN1558A	GUARNIZIONE TENUTA CAMINO		K0H7291A	KIT DISCO E GUARNIZIONE TENUTA CAMINO	<table border="1"> <thead> <tr> <th>Codice</th> <th>Descrizione</th> <th>Qtà</th> <th>UM</th> </tr> </thead> <tbody> <tr> <td>0H7291A0</td> <td>DISCO TENUTA CAMINO</td> <td>1</td> <td>PZ</td> </tr> <tr> <td>GN1558A0</td> <td>GUARNIZIONE TENUTA CAMINO</td> <td>1</td> <td>PZ</td> </tr> </tbody> </table>	Codice	Descrizione	Qtà	UM	0H7291A0	DISCO TENUTA CAMINO	1	PZ	GN1558A0	GUARNIZIONE TENUTA CAMINO	1	PZ
Codice	Descrizione	Qtà	UM														
0H7291A0	DISCO TENUTA CAMINO	1	PZ														
GN1558A0	GUARNIZIONE TENUTA CAMINO	1	PZ														
0H7291A	DISCO TENUTA CAMINO		K0H7291A	KIT DISCO E GUARNIZIONE TENUTA CAMINO	<table border="1"> <thead> <tr> <th>Codice</th> <th>Descrizione</th> <th>Qtà</th> <th>UM</th> </tr> </thead> <tbody> <tr> <td>0H7291A0</td> <td>DISCO TENUTA CAMINO</td> <td>1</td> <td>PZ</td> </tr> <tr> <td>GN1558A0</td> <td>GUARNIZIONE TENUTA CAMINO</td> <td>1</td> <td>PZ</td> </tr> </tbody> </table>	Codice	Descrizione	Qtà	UM	0H7291A0	DISCO TENUTA CAMINO	1	PZ	GN1558A0	GUARNIZIONE TENUTA CAMINO	1	PZ
Codice	Descrizione	Qtà	UM														
0H7291A0	DISCO TENUTA CAMINO	1	PZ														
GN1558A0	GUARNIZIONE TENUTA CAMINO	1	PZ														
VM1118A	GUIDA SX SERBATOIO DET&RINSE PLUS		KVM1118A	KIT GUIDA SX SERBATOIO DET.M	<table border="1"> <thead> <tr> <th>Codice</th> <th>Descrizione</th> <th>Qtà</th> <th>UM</th> </tr> </thead> <tbody> <tr> <td>V11220A1</td> <td>VITE AUTOFILETTA NTE 4.2X11 TCS+ MARUTE</td> <td>2</td> <td>PZ</td> </tr> <tr> <td>VM1118A0</td> <td>GUIDA SX SERBATOIO DET&RINSE PLUS</td> <td>1</td> <td>PZ</td> </tr> </tbody> </table>	Codice	Descrizione	Qtà	UM	V11220A1	VITE AUTOFILETTA NTE 4.2X11 TCS+ MARUTE	2	PZ	VM1118A0	GUIDA SX SERBATOIO DET&RINSE PLUS	1	PZ
Codice	Descrizione	Qtà	UM														
V11220A1	VITE AUTOFILETTA NTE 4.2X11 TCS+ MARUTE	2	PZ														
VM1118A0	GUIDA SX SERBATOIO DET&RINSE PLUS	1	PZ														

COMPONENTE			RICAMBIO																																																																		
Codice	Descrizione	Immagine	Codice	Descrizione	Lista componenti																																																																
VM1119A	GUIDA DX SERBATOIO DET&RINSE PLUS		KVM1119A	KIT GUIDA DX SERBATOIO DET.M	<table border="1"> <thead> <tr> <th>Codice</th> <th>Descrizione</th> <th>Qtà</th> <th>UM</th> </tr> </thead> <tbody> <tr> <td>VI1220A1</td> <td>VITE AUTOFILETTA NTE 4.2X11 TCS+ MARUTE</td> <td>2</td> <td>PZ</td> </tr> <tr> <td>VM1119A0</td> <td>GUIDA DX SERBATOIO DET&RINSE PLUS</td> <td>1</td> <td>PZ</td> </tr> </tbody> </table>	Codice	Descrizione	Qtà	UM	VI1220A1	VITE AUTOFILETTA NTE 4.2X11 TCS+ MARUTE	2	PZ	VM1119A0	GUIDA DX SERBATOIO DET&RINSE PLUS	1	PZ																																																				
Codice	Descrizione	Qtà	UM																																																																		
VI1220A1	VITE AUTOFILETTA NTE 4.2X11 TCS+ MARUTE	2	PZ																																																																		
VM1119A0	GUIDA DX SERBATOIO DET&RINSE PLUS	1	PZ																																																																		
SB1015A	SERBATOIO DETERGENTE 4L + ROMPI-CIALDA		XUC060	KIT TANICA DETERGENTE PER LIEVITATORE	<table border="1"> <thead> <tr> <th>Codice</th> <th>Descrizione</th> <th>Qtà</th> <th>UM</th> </tr> </thead> <tbody> <tr> <td>0H7558B0</td> <td>GUIDA TANICA DETERGENTE</td> <td>1</td> <td>PZ</td> </tr> <tr> <td>0H7559B0</td> <td>FRONTALINO KIT TANICA</td> <td>2</td> <td>PZ</td> </tr> <tr> <td>0H7656A0</td> <td>GUIDA TANICA DETERGENTE</td> <td>1</td> <td>PZ</td> </tr> <tr> <td>0H7657A0</td> <td>FRONTALINO KIT TANICA</td> <td>2</td> <td>PZ</td> </tr> <tr> <td>CE1016A0</td> <td>TERMINALE AD OCCHIELLO D=4,3 MM</td> <td>2</td> <td>PZ</td> </tr> <tr> <td>CE1630A1</td> <td>CAVO UNIP AWG16 ST.3135 NERO</td> <td>0.680</td> <td>M</td> </tr> <tr> <td>EL1220A0</td> <td>RACCORDO DRITTO Ø8F-Ø8F</td> <td>1</td> <td>PZ</td> </tr> <tr> <td>IP1385A1</td> <td>IMB POL ANGOLARE 110X80X2000 D30</td> <td>3.520</td> <td>M</td> </tr> <tr> <td>RC1019A0</td> <td>FASCETTA ELASTICA D10 ZINCATA</td> <td>2</td> <td>PZ</td> </tr> <tr> <td>SB1015A1</td> <td>SERBATOIO DETERGENTE 4L + ROMPI-CIALD</td> <td>1</td> <td>PZ</td> </tr> <tr> <td>TB2820A0</td> <td>TUBO EPDM 6X10</td> <td>2</td> <td>M</td> </tr> <tr> <td>VI1220A1</td> <td>VITE AUTOFILETTA NTE 4.2X11 TCS+ MARUTE</td> <td>9</td> <td>PZ</td> </tr> <tr> <td>VI1225A0</td> <td>RIVETTO STRUTT. 4X10.1 INOX</td> <td>8</td> <td>PZ</td> </tr> <tr> <td>VI1950A0</td> <td>VITE AUTOFORANT E 4,2X13 TCB INOX</td> <td>4</td> <td>PZ</td> </tr> <tr> <td>VL1047A1</td> <td>PORTAGOMM A D6 CODOLO D8</td> <td>2</td> <td>PZ</td> </tr> </tbody> </table>	Codice	Descrizione	Qtà	UM	0H7558B0	GUIDA TANICA DETERGENTE	1	PZ	0H7559B0	FRONTALINO KIT TANICA	2	PZ	0H7656A0	GUIDA TANICA DETERGENTE	1	PZ	0H7657A0	FRONTALINO KIT TANICA	2	PZ	CE1016A0	TERMINALE AD OCCHIELLO D=4,3 MM	2	PZ	CE1630A1	CAVO UNIP AWG16 ST.3135 NERO	0.680	M	EL1220A0	RACCORDO DRITTO Ø8F-Ø8F	1	PZ	IP1385A1	IMB POL ANGOLARE 110X80X2000 D30	3.520	M	RC1019A0	FASCETTA ELASTICA D10 ZINCATA	2	PZ	SB1015A1	SERBATOIO DETERGENTE 4L + ROMPI-CIALD	1	PZ	TB2820A0	TUBO EPDM 6X10	2	M	VI1220A1	VITE AUTOFILETTA NTE 4.2X11 TCS+ MARUTE	9	PZ	VI1225A0	RIVETTO STRUTT. 4X10.1 INOX	8	PZ	VI1950A0	VITE AUTOFORANT E 4,2X13 TCB INOX	4	PZ	VL1047A1	PORTAGOMM A D6 CODOLO D8	2	PZ
Codice	Descrizione	Qtà	UM																																																																		
0H7558B0	GUIDA TANICA DETERGENTE	1	PZ																																																																		
0H7559B0	FRONTALINO KIT TANICA	2	PZ																																																																		
0H7656A0	GUIDA TANICA DETERGENTE	1	PZ																																																																		
0H7657A0	FRONTALINO KIT TANICA	2	PZ																																																																		
CE1016A0	TERMINALE AD OCCHIELLO D=4,3 MM	2	PZ																																																																		
CE1630A1	CAVO UNIP AWG16 ST.3135 NERO	0.680	M																																																																		
EL1220A0	RACCORDO DRITTO Ø8F-Ø8F	1	PZ																																																																		
IP1385A1	IMB POL ANGOLARE 110X80X2000 D30	3.520	M																																																																		
RC1019A0	FASCETTA ELASTICA D10 ZINCATA	2	PZ																																																																		
SB1015A1	SERBATOIO DETERGENTE 4L + ROMPI-CIALD	1	PZ																																																																		
TB2820A0	TUBO EPDM 6X10	2	M																																																																		
VI1220A1	VITE AUTOFILETTA NTE 4.2X11 TCS+ MARUTE	9	PZ																																																																		
VI1225A0	RIVETTO STRUTT. 4X10.1 INOX	8	PZ																																																																		
VI1950A0	VITE AUTOFORANT E 4,2X13 TCB INOX	4	PZ																																																																		
VL1047A1	PORTAGOMM A D6 CODOLO D8	2	PZ																																																																		

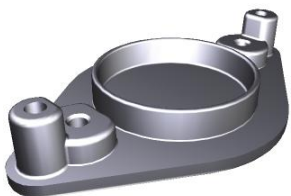
COMPONENTE			RICAMBIO																						
Codice	Descrizione	Immagine	Codice	Descrizione	Lista componenti																				
SB1015A	SERBATOIO DETERGENTE 4L + ROMPI-CIALDA		XUC060	KIT TANICA DETERGENTE PER LIEVITATORE	<table border="1"> <thead> <tr> <th>Codice</th> <th>Descrizione</th> <th>Qtà</th> <th>UM</th> </tr> </thead> <tbody> <tr> <td>VL1047A2</td> <td>PORTAGOMM A D6 CODOLO D8</td> <td>2</td> <td>PZ</td> </tr> <tr> <td>VM1059A1</td> <td>FILM TERMORETRA IBILE H800</td> <td>2</td> <td>M</td> </tr> <tr> <td>VM1197A0</td> <td>CORNICE SERBATOIO DET. MM BIG</td> <td>2</td> <td>PZ</td> </tr> <tr> <td>VM1198A0</td> <td>CLIP BLOCCA CORNICE SERBATOIO DET. MM</td> <td>8</td> <td>PZ</td> </tr> </tbody> </table>	Codice	Descrizione	Qtà	UM	VL1047A2	PORTAGOMM A D6 CODOLO D8	2	PZ	VM1059A1	FILM TERMORETRA IBILE H800	2	M	VM1197A0	CORNICE SERBATOIO DET. MM BIG	2	PZ	VM1198A0	CLIP BLOCCA CORNICE SERBATOIO DET. MM	8	PZ
			Codice	Descrizione	Qtà	UM																			
VL1047A2	PORTAGOMM A D6 CODOLO D8	2	PZ																						
VM1059A1	FILM TERMORETRA IBILE H800	2	M																						
VM1197A0	CORNICE SERBATOIO DET. MM BIG	2	PZ																						
VM1198A0	CLIP BLOCCA CORNICE SERBATOIO DET. MM	8	PZ																						
KSB1015A	KIT SERBATOIO DETERGENTE 4L	<table border="1"> <thead> <tr> <th>Codice</th> <th>Descrizione</th> <th>Qtà</th> <th>UM</th> </tr> </thead> <tbody> <tr> <td>IP1385A1</td> <td>IMB POL ANGOLARE 110X80X2000 D30</td> <td>1.200</td> <td>M</td> </tr> <tr> <td>IP1410A0</td> <td>IMB POL SALVAVETRO 300X300X8 D1</td> <td>2</td> <td>PZ</td> </tr> <tr> <td>SB1015A1</td> <td>SERBATOIO DETERGENTE 4L + ROMPI-CIALD</td> <td>1</td> <td>PZ</td> </tr> <tr> <td>VM1059A1</td> <td>FILM TERMORETRA IBILE H800</td> <td>1.200</td> <td>M</td> </tr> </tbody> </table>	Codice	Descrizione	Qtà	UM	IP1385A1	IMB POL ANGOLARE 110X80X2000 D30	1.200	M	IP1410A0	IMB POL SALVAVETRO 300X300X8 D1	2	PZ	SB1015A1	SERBATOIO DETERGENTE 4L + ROMPI-CIALD	1	PZ	VM1059A1	FILM TERMORETRA IBILE H800	1.200	M			
Codice	Descrizione	Qtà	UM																						
IP1385A1	IMB POL ANGOLARE 110X80X2000 D30	1.200	M																						
IP1410A0	IMB POL SALVAVETRO 300X300X8 D1	2	PZ																						
SB1015A1	SERBATOIO DETERGENTE 4L + ROMPI-CIALD	1	PZ																						
VM1059A1	FILM TERMORETRA IBILE H800	1.200	M																						
VM2310A	PIASTRINA A L COPRI FORI STAFFA SUP		KVM2310A	KIT PIASTRINA A L COPRI FORI STAFFA SUP	<table border="1"> <thead> <tr> <th>Codice</th> <th>Descrizione</th> <th>Qtà</th> <th>UM</th> </tr> </thead> <tbody> <tr> <td>VM2310A0</td> <td>PIASTRINA A L COPRI FORI STAFFA SUP</td> <td>1</td> <td>PZ</td> </tr> </tbody> </table>	Codice	Descrizione	Qtà	UM	VM2310A0	PIASTRINA A L COPRI FORI STAFFA SUP	1	PZ												
Codice	Descrizione	Qtà	UM																						
VM2310A0	PIASTRINA A L COPRI FORI STAFFA SUP	1	PZ																						
VM1192A	COPERCHIO POST. SCROCCO MANIGLIA CT BT		KVM1191A	KIT SCROCCO MANIGLIA SX CT BT	<table border="1"> <thead> <tr> <th>Codice</th> <th>Descrizione</th> <th>Qtà</th> <th>UM</th> </tr> </thead> <tbody> <tr> <td>VI0239A1</td> <td>VITE AUTOFIL. 4.2X25 TCB+ INOX</td> <td>2</td> <td>PZ</td> </tr> <tr> <td>VI1220A1</td> <td>VITE AUTOFILETTA NTE 4.2X11 TCS+ MARUTE</td> <td>2</td> <td>PZ</td> </tr> <tr> <td>VM1191A2</td> <td>SCROCCO MANIGLIA SX CT BT</td> <td>1</td> <td>PZ</td> </tr> </tbody> </table>	Codice	Descrizione	Qtà	UM	VI0239A1	VITE AUTOFIL. 4.2X25 TCB+ INOX	2	PZ	VI1220A1	VITE AUTOFILETTA NTE 4.2X11 TCS+ MARUTE	2	PZ	VM1191A2	SCROCCO MANIGLIA SX CT BT	1	PZ				
Codice	Descrizione	Qtà	UM																						
VI0239A1	VITE AUTOFIL. 4.2X25 TCB+ INOX	2	PZ																						
VI1220A1	VITE AUTOFILETTA NTE 4.2X11 TCS+ MARUTE	2	PZ																						
VM1191A2	SCROCCO MANIGLIA SX CT BT	1	PZ																						

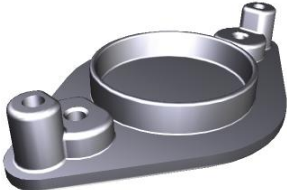
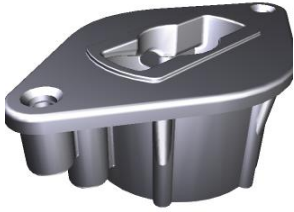
COMPONENTE			RICAMBIO																										
Codice	Descrizione	Immagine	Codice	Descrizione	Lista componenti																								
VM1192A	COPERCHIO POST. SCROCCO MANIGLIA CT BT		KVM1191A	KIT SCROCCO MANIGLIA SX CT BT	<table border="1"> <thead> <tr> <th>Codice</th> <th>Descrizione</th> <th>Qtà</th> <th>UM</th> </tr> </thead> <tbody> <tr> <td>VM1192A1</td> <td>COPERCHIO POST. SCROCCO MANIGLIA CT BT</td> <td>1</td> <td>PZ</td> </tr> <tr> <td>VM1460A0</td> <td>COPERCHIO DX SCROCCO PORTA XBC/XVC</td> <td>1</td> <td>PZ</td> </tr> </tbody> </table>	Codice	Descrizione	Qtà	UM	VM1192A1	COPERCHIO POST. SCROCCO MANIGLIA CT BT	1	PZ	VM1460A0	COPERCHIO DX SCROCCO PORTA XBC/XVC	1	PZ												
			Codice	Descrizione	Qtà	UM																							
VM1192A1	COPERCHIO POST. SCROCCO MANIGLIA CT BT	1	PZ																										
VM1460A0	COPERCHIO DX SCROCCO PORTA XBC/XVC	1	PZ																										
KVM1190A	KIT SCROCCO MANIGLIA DX CT BT	<table border="1"> <thead> <tr> <th>Codice</th> <th>Descrizione</th> <th>Qtà</th> <th>UM</th> </tr> </thead> <tbody> <tr> <td>VI0239A1</td> <td>VITE AUTOFIL. 4.2X25 TCB+ INOX</td> <td>2</td> <td>PZ</td> </tr> <tr> <td>VI1220A1</td> <td>VITE AUTOFILETTA NTE 4.2X11 TCS+ MARUTE</td> <td>2</td> <td>PZ</td> </tr> <tr> <td>VM1190A2</td> <td>SCROCCO MANIGLIA DX CT BT</td> <td>1</td> <td>PZ</td> </tr> <tr> <td>VM1192A1</td> <td>COPERCHIO POST. SCROCCO MANIGLIA CT BT</td> <td>1</td> <td>PZ</td> </tr> <tr> <td>VM1460A0</td> <td>COPERCHIO DX SCROCCO PORTA XBC/XVC</td> <td>1</td> <td>PZ</td> </tr> </tbody> </table>	Codice	Descrizione	Qtà	UM	VI0239A1	VITE AUTOFIL. 4.2X25 TCB+ INOX	2	PZ	VI1220A1	VITE AUTOFILETTA NTE 4.2X11 TCS+ MARUTE	2	PZ	VM1190A2	SCROCCO MANIGLIA DX CT BT	1	PZ	VM1192A1	COPERCHIO POST. SCROCCO MANIGLIA CT BT	1	PZ	VM1460A0	COPERCHIO DX SCROCCO PORTA XBC/XVC	1	PZ			
Codice	Descrizione	Qtà	UM																										
VI0239A1	VITE AUTOFIL. 4.2X25 TCB+ INOX	2	PZ																										
VI1220A1	VITE AUTOFILETTA NTE 4.2X11 TCS+ MARUTE	2	PZ																										
VM1190A2	SCROCCO MANIGLIA DX CT BT	1	PZ																										
VM1192A1	COPERCHIO POST. SCROCCO MANIGLIA CT BT	1	PZ																										
VM1460A0	COPERCHIO DX SCROCCO PORTA XBC/XVC	1	PZ																										
VM1191A	SCROCCO MANIGLIA SX CT BT		KVM1191A	KIT SCROCCO MANIGLIA SX CT BT	<table border="1"> <thead> <tr> <th>Codice</th> <th>Descrizione</th> <th>Qtà</th> <th>UM</th> </tr> </thead> <tbody> <tr> <td>VI0239A1</td> <td>VITE AUTOFIL. 4.2X25 TCB+ INOX</td> <td>2</td> <td>PZ</td> </tr> <tr> <td>VI1220A1</td> <td>VITE AUTOFILETTA NTE 4.2X11 TCS+ MARUTE</td> <td>2</td> <td>PZ</td> </tr> <tr> <td>VM1191A2</td> <td>SCROCCO MANIGLIA SX CT BT</td> <td>1</td> <td>PZ</td> </tr> <tr> <td>VM1192A1</td> <td>COPERCHIO POST. SCROCCO MANIGLIA CT BT</td> <td>1</td> <td>PZ</td> </tr> <tr> <td>VM1460A0</td> <td>COPERCHIO DX SCROCCO PORTA XBC/XVC</td> <td>1</td> <td>PZ</td> </tr> </tbody> </table>	Codice	Descrizione	Qtà	UM	VI0239A1	VITE AUTOFIL. 4.2X25 TCB+ INOX	2	PZ	VI1220A1	VITE AUTOFILETTA NTE 4.2X11 TCS+ MARUTE	2	PZ	VM1191A2	SCROCCO MANIGLIA SX CT BT	1	PZ	VM1192A1	COPERCHIO POST. SCROCCO MANIGLIA CT BT	1	PZ	VM1460A0	COPERCHIO DX SCROCCO PORTA XBC/XVC	1	PZ
Codice	Descrizione	Qtà	UM																										
VI0239A1	VITE AUTOFIL. 4.2X25 TCB+ INOX	2	PZ																										
VI1220A1	VITE AUTOFILETTA NTE 4.2X11 TCS+ MARUTE	2	PZ																										
VM1191A2	SCROCCO MANIGLIA SX CT BT	1	PZ																										
VM1192A1	COPERCHIO POST. SCROCCO MANIGLIA CT BT	1	PZ																										
VM1460A0	COPERCHIO DX SCROCCO PORTA XBC/XVC	1	PZ																										



COMPONENTE			RICAMBIO																										
Codice	Descrizione	Immagine	Codice	Descrizione	Lista componenti																								
VM1992A	CASSETTO RACCOGLI GOCCE 860		KVM1992A	KIT CASSETTO RACCOGLI GOCCE	<table border="1"> <thead> <tr> <th>Codice</th> <th>Descrizione</th> <th>Qtà</th> <th>UM</th> </tr> </thead> <tbody> <tr> <td>VM1220A0</td> <td>CLIP FISSAGGIO CASSETTO RACCOGLIGO GOCCE</td> <td>4</td> <td>PZ</td> </tr> <tr> <td>VM1794A0</td> <td>FASCETTA 250X4.8 PA66 NERA</td> <td>2</td> <td>PZ</td> </tr> <tr> <td>VM1992A0</td> <td>CASSETTO RACCOGLI GOCCE 860</td> <td>1</td> <td>PZ</td> </tr> <tr> <td>VM2074A0</td> <td>CLIP CON VITE PER SUPPORTO CASSETTO</td> <td>4</td> <td>PZ</td> </tr> <tr> <td>VM2103A0</td> <td>PIASTRINA FERMAFASCE TTA</td> <td>2</td> <td>PZ</td> </tr> </tbody> </table>	Codice	Descrizione	Qtà	UM	VM1220A0	CLIP FISSAGGIO CASSETTO RACCOGLIGO GOCCE	4	PZ	VM1794A0	FASCETTA 250X4.8 PA66 NERA	2	PZ	VM1992A0	CASSETTO RACCOGLI GOCCE 860	1	PZ	VM2074A0	CLIP CON VITE PER SUPPORTO CASSETTO	4	PZ	VM2103A0	PIASTRINA FERMAFASCE TTA	2	PZ
Codice	Descrizione	Qtà	UM																										
VM1220A0	CLIP FISSAGGIO CASSETTO RACCOGLIGO GOCCE	4	PZ																										
VM1794A0	FASCETTA 250X4.8 PA66 NERA	2	PZ																										
VM1992A0	CASSETTO RACCOGLI GOCCE 860	1	PZ																										
VM2074A0	CLIP CON VITE PER SUPPORTO CASSETTO	4	PZ																										
VM2103A0	PIASTRINA FERMAFASCE TTA	2	PZ																										
0F1504A	SCHIENA XEBC-06EU-E		0F1504A0	SCHIENA XEBC-06EU-E																									
0H2561A	CONTROSTAFFA PORTA MM		0H2561A0	CONTROSTAFFA PORTA MM																									
VI1995A	VITE M5X25 TCEI INOX		VI1995A0	VITE M5X25 TCEI INOX																									

COMPONENTE			RICAMBIO																														
Codice	Descrizione	Immagine	Codice	Descrizione	Lista componenti																												
VM2352A	TAPPO SX COPRI VITI STAFFA PORTA INF MM		VM2352A0	TAPPO SX COPRI VITI STAFFA PORTA INF MM																													
VM2353A	TAPPO DX COPRI VITI STAFFA PORTA INF MM		VM2353A0	TAPPO DX COPRI VITI STAFFA PORTA INF MM																													
VM1240A	TAPPO NYLON SUPPORTO CONTROSTAFFA		KVM1240A	KIT TAPPO SUPPORTO CONTROSTAFFA 4P	<table border="1"> <thead> <tr> <th>Codice</th> <th>Descrizione</th> <th>Qta</th> <th>UM</th> </tr> </thead> <tbody> <tr> <td>VM1240A0</td> <td>TAPPO NYLON SUPPORTO CONTROSTAF FA</td> <td>4</td> <td>PZ</td> </tr> </tbody> </table>	Codice	Descrizione	Qta	UM	VM1240A0	TAPPO NYLON SUPPORTO CONTROSTAF FA	4	PZ																				
Codice	Descrizione	Qta	UM																														
VM1240A0	TAPPO NYLON SUPPORTO CONTROSTAF FA	4	PZ																														
VM2273A	STAFFA INF PORTA MM SX		KVM2273A	KIT STAFFA INFERIORE PORTA MIND.MAPS SX	<table border="1"> <thead> <tr> <th>Codice</th> <th>Descrizione</th> <th>Qta</th> <th>UM</th> </tr> </thead> <tbody> <tr> <td>0H7330A0</td> <td>RONDELLA STAFFA INFERIORE PORTA MM</td> <td>2</td> <td>PZ</td> </tr> <tr> <td>V11995A0</td> <td>VITE M5X25 TCEI INOX</td> <td>4</td> <td>PZ</td> </tr> <tr> <td>VM2273A0</td> <td>STAFFA INF PORTA MM SX</td> <td>1</td> <td>PZ</td> </tr> <tr> <td>VM2273A1</td> <td>STAFFA INF PORTA MM SX</td> <td>1</td> <td>PZ</td> </tr> <tr> <td>VM2352A0</td> <td>TAPPO SX COPRI VITI STAFFA PORTA INF M</td> <td>2</td> <td>PZ</td> </tr> <tr> <td>VM2353A0</td> <td>TAPPO DX COPRI VITI STAFFA PORTA INF M</td> <td>1</td> <td>PZ</td> </tr> </tbody> </table>	Codice	Descrizione	Qta	UM	0H7330A0	RONDELLA STAFFA INFERIORE PORTA MM	2	PZ	V11995A0	VITE M5X25 TCEI INOX	4	PZ	VM2273A0	STAFFA INF PORTA MM SX	1	PZ	VM2273A1	STAFFA INF PORTA MM SX	1	PZ	VM2352A0	TAPPO SX COPRI VITI STAFFA PORTA INF M	2	PZ	VM2353A0	TAPPO DX COPRI VITI STAFFA PORTA INF M	1	PZ
Codice	Descrizione	Qta	UM																														
0H7330A0	RONDELLA STAFFA INFERIORE PORTA MM	2	PZ																														
V11995A0	VITE M5X25 TCEI INOX	4	PZ																														
VM2273A0	STAFFA INF PORTA MM SX	1	PZ																														
VM2273A1	STAFFA INF PORTA MM SX	1	PZ																														
VM2352A0	TAPPO SX COPRI VITI STAFFA PORTA INF M	2	PZ																														
VM2353A0	TAPPO DX COPRI VITI STAFFA PORTA INF M	1	PZ																														

COMPONENTE			RICAMBIO														
Codice	Descrizione	Immagine	Codice	Descrizione	Lista componenti												
0H7675A	CONTROSTAFFA PORTA SERIE 6																
0H2561A	CONTROSTAFFA PORTA MM		0H2561A0	CONTROSTAFFA PORTA MM													
VI1995A	VITE M5X25 TCEI INOX		VI1995A0	VITE M5X25 TCEI INOX													
VM1240A	TAPPO NYLON SUPPORTO CONTROSTAFFA		KVM1240A	KIT TAPPO SUPPORTO CONTROSTAFFA 4P	<table border="1"> <thead> <tr> <th>Codice</th> <th>Descrizione</th> <th>Qtà</th> <th>UM</th> </tr> </thead> <tbody> <tr> <td>VM1240A0</td> <td>TAPPO NYLON SUPPORTO CONTROSTAF FA</td> <td>4</td> <td>PZ</td> </tr> </tbody> </table>	Codice	Descrizione	Qtà	UM	VM1240A0	TAPPO NYLON SUPPORTO CONTROSTAF FA	4	PZ				
Codice	Descrizione	Qtà	UM														
VM1240A0	TAPPO NYLON SUPPORTO CONTROSTAF FA	4	PZ														
VM2298A	COPERCHIO SUP STAFFA PORTA MM		KVM2298A	KIT COPERCHIO SUP STAFFA PORTA MIND MAPS	<table border="1"> <thead> <tr> <th>Codice</th> <th>Descrizione</th> <th>Qtà</th> <th>UM</th> </tr> </thead> <tbody> <tr> <td>VI1220A0</td> <td>VITE AUTOFIL. 4,2X12 TCB MARUTEX PREMAGN</td> <td>2</td> <td>PZ</td> </tr> <tr> <td>VM2298A0</td> <td>COPERCHIO SUP STAFFA PORTA MM</td> <td>1</td> <td>PZ</td> </tr> </tbody> </table>	Codice	Descrizione	Qtà	UM	VI1220A0	VITE AUTOFIL. 4,2X12 TCB MARUTEX PREMAGN	2	PZ	VM2298A0	COPERCHIO SUP STAFFA PORTA MM	1	PZ
Codice	Descrizione	Qtà	UM														
VI1220A0	VITE AUTOFIL. 4,2X12 TCB MARUTEX PREMAGN	2	PZ														
VM2298A0	COPERCHIO SUP STAFFA PORTA MM	1	PZ														



COMPONENTE			RICAMBIO																										
Codice	Descrizione	Immagine	Codice	Descrizione	Lista componenti																								
VM2271A	STAFFA SUP PORTA MM SX		KVM2271A	KIT STAFFA SUPERIORE PORTA MIND.MAPS SX	<table border="1"> <thead> <tr> <th>Codice</th> <th>Descrizione</th> <th>Qtà</th> <th>UM</th> </tr> </thead> <tbody> <tr> <td>VI1220A1</td> <td>VITE AUTOFILETTA NTE 4.2X11 TCS+ MARUTE</td> <td>2</td> <td>PZ</td> </tr> <tr> <td>VI1995A0</td> <td>VITE M5X25 TCEI INOX</td> <td>4</td> <td>PZ</td> </tr> <tr> <td>VI1997A0</td> <td>RONDELLA PIANA 5X10X1 ZN</td> <td>4</td> <td>PZ</td> </tr> <tr> <td>VM2271A0</td> <td>STAFFA SUP PORTA MM SX</td> <td>1</td> <td>PZ</td> </tr> <tr> <td>VM2298A0</td> <td>COPERCHIO SUP STAFFA PORTA MM</td> <td>1</td> <td>PZ</td> </tr> </tbody> </table>	Codice	Descrizione	Qtà	UM	VI1220A1	VITE AUTOFILETTA NTE 4.2X11 TCS+ MARUTE	2	PZ	VI1995A0	VITE M5X25 TCEI INOX	4	PZ	VI1997A0	RONDELLA PIANA 5X10X1 ZN	4	PZ	VM2271A0	STAFFA SUP PORTA MM SX	1	PZ	VM2298A0	COPERCHIO SUP STAFFA PORTA MM	1	PZ
Codice	Descrizione	Qtà	UM																										
VI1220A1	VITE AUTOFILETTA NTE 4.2X11 TCS+ MARUTE	2	PZ																										
VI1995A0	VITE M5X25 TCEI INOX	4	PZ																										
VI1997A0	RONDELLA PIANA 5X10X1 ZN	4	PZ																										
VM2271A0	STAFFA SUP PORTA MM SX	1	PZ																										
VM2298A0	COPERCHIO SUP STAFFA PORTA MM	1	PZ																										
0H7675A	CONTROSTAFFA PORTA SERIE 6																												
PD1074A	PIEDE H100 BICOMPONENTE QUADRO		KPD1074A	KIT PIEDINO H100 PD1074A0	<table border="1"> <thead> <tr> <th>Codice</th> <th>Descrizione</th> <th>Qtà</th> <th>UM</th> </tr> </thead> <tbody> <tr> <td>PD1074A0</td> <td>PIEDE H100 BICOMPONEN TE QUADRO</td> <td>1</td> <td>PZ</td> </tr> <tr> <td>PD1075A0</td> <td>STAFFA BLOCCAGGIO PIEDE PD1074</td> <td>1</td> <td>PZ</td> </tr> <tr> <td>VI1220A1</td> <td>VITE AUTOFILETTA NTE 4.2X11 TCS+ MARUTE</td> <td>5</td> <td>PZ</td> </tr> </tbody> </table>	Codice	Descrizione	Qtà	UM	PD1074A0	PIEDE H100 BICOMPONEN TE QUADRO	1	PZ	PD1075A0	STAFFA BLOCCAGGIO PIEDE PD1074	1	PZ	VI1220A1	VITE AUTOFILETTA NTE 4.2X11 TCS+ MARUTE	5	PZ								
Codice	Descrizione	Qtà	UM																										
PD1074A0	PIEDE H100 BICOMPONEN TE QUADRO	1	PZ																										
PD1075A0	STAFFA BLOCCAGGIO PIEDE PD1074	1	PZ																										
VI1220A1	VITE AUTOFILETTA NTE 4.2X11 TCS+ MARUTE	5	PZ																										
PD1075A	STAFFA BLOCCAGGIO PIEDE PD1074		KPD1075A	KIT STAFFA BLOCCAGGIO PIEDE PD1074A0	<table border="1"> <thead> <tr> <th>Codice</th> <th>Descrizione</th> <th>Qtà</th> <th>UM</th> </tr> </thead> <tbody> <tr> <td>PD1075A0</td> <td>STAFFA BLOCCAGGIO PIEDE PD1074</td> <td>4</td> <td>PZ</td> </tr> <tr> <td>VI1950A0</td> <td>VITE AUTOFORANT E 4,2X13 TCB INOX</td> <td>8</td> <td>PZ</td> </tr> </tbody> </table>	Codice	Descrizione	Qtà	UM	PD1075A0	STAFFA BLOCCAGGIO PIEDE PD1074	4	PZ	VI1950A0	VITE AUTOFORANT E 4,2X13 TCB INOX	8	PZ												
Codice	Descrizione	Qtà	UM																										
PD1075A0	STAFFA BLOCCAGGIO PIEDE PD1074	4	PZ																										
VI1950A0	VITE AUTOFORANT E 4,2X13 TCB INOX	8	PZ																										

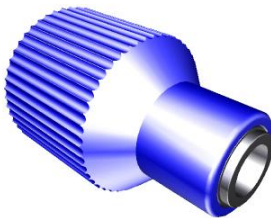

COMPONENTE			RICAMBIO										
Codice	Descrizione	Immagine	Codice	Descrizione	Lista componenti								
0H2561A	CONTROSTAFFA PORTA MM		0H2561A0	CONTROSTAFFA PORTA MM									
VM1240A	TAPPO NYLON SUPPORTO CONTROSTAFFA		KVM1240A	KIT TAPPO SUPPORTO CONTROSTAFFA 4P	<table border="1"> <thead> <tr> <th>Codice</th> <th>Descrizione</th> <th>Qtà</th> <th>UM</th> </tr> </thead> <tbody> <tr> <td>VM1240A0</td> <td>TAPPO NYLON SUPPORTO CONTROSTAF FA</td> <td>4</td> <td>PZ</td> </tr> </tbody> </table>	Codice	Descrizione	Qtà	UM	VM1240A0	TAPPO NYLON SUPPORTO CONTROSTAF FA	4	PZ
Codice	Descrizione	Qtà	UM										
VM1240A0	TAPPO NYLON SUPPORTO CONTROSTAF FA	4	PZ										
VM2310A	PIASTRINA A L COPRI FORI STAFFA SUP		KVM2310A	KIT PIASTRINA A L COPRI FORI STAFFA SUP	<table border="1"> <thead> <tr> <th>Codice</th> <th>Descrizione</th> <th>Qtà</th> <th>UM</th> </tr> </thead> <tbody> <tr> <td>VM2310A0</td> <td>PIASTRINA A L COPRI FORI STAFFA SUP</td> <td>1</td> <td>PZ</td> </tr> </tbody> </table>	Codice	Descrizione	Qtà	UM	VM2310A0	PIASTRINA A L COPRI FORI STAFFA SUP	1	PZ
Codice	Descrizione	Qtà	UM										
VM2310A0	PIASTRINA A L COPRI FORI STAFFA SUP	1	PZ										
0H7675A	CONTROSTAFFA PORTA SERIE 6												
0D2305B	COPERCHIO XEBC-E												

COMPONENTE			RICAMBIO																										
Codice	Descrizione	Immagine	Codice	Descrizione	Lista componenti																								
0D2308A	FIANCO SX XEBC-06EU-E																												
VM2061A	PASSAPARETE CAVI ACCESSORI COMPLETO		KVM1505A	KIT PASSAPARETE CON DIAFRAMMA	<table border="1"> <thead> <tr> <th>Codice</th> <th>Descrizione</th> <th>Qtà</th> <th>UM</th> </tr> </thead> <tbody> <tr> <td>VI1220A1</td> <td>VITE AUTOFILETTA NTE 4.2X11 TCS+ MARUTE</td> <td>1</td> <td>PZ</td> </tr> <tr> <td>VM1505A0</td> <td>PASSAPARET E CON DIAFRAMMA</td> <td>3</td> <td>PZ</td> </tr> <tr> <td>VM2055A0</td> <td>PASSAPARET E CAVI ACCESSORI SUP.</td> <td>1</td> <td>PZ</td> </tr> <tr> <td>VM2056A0</td> <td>PASSAPARET E CAVI ACCESSORI INF.</td> <td>1</td> <td>PZ</td> </tr> <tr> <td>VM2061A0</td> <td>PASSAPARET E CAVI ACCESSORI COMPLETO</td> <td>1</td> <td>PZ</td> </tr> </tbody> </table>	Codice	Descrizione	Qtà	UM	VI1220A1	VITE AUTOFILETTA NTE 4.2X11 TCS+ MARUTE	1	PZ	VM1505A0	PASSAPARET E CON DIAFRAMMA	3	PZ	VM2055A0	PASSAPARET E CAVI ACCESSORI SUP.	1	PZ	VM2056A0	PASSAPARET E CAVI ACCESSORI INF.	1	PZ	VM2061A0	PASSAPARET E CAVI ACCESSORI COMPLETO	1	PZ
Codice	Descrizione	Qtà	UM																										
VI1220A1	VITE AUTOFILETTA NTE 4.2X11 TCS+ MARUTE	1	PZ																										
VM1505A0	PASSAPARET E CON DIAFRAMMA	3	PZ																										
VM2055A0	PASSAPARET E CAVI ACCESSORI SUP.	1	PZ																										
VM2056A0	PASSAPARET E CAVI ACCESSORI INF.	1	PZ																										
VM2061A0	PASSAPARET E CAVI ACCESSORI COMPLETO	1	PZ																										
0D2309A	FIANCO DX XEBC-06EU-E																												
RC1365A	RACCORDO JG FEMMINA 3/4"-10		KRC1365A	KIT RICAMBIO ATTACCO ACQUA DI RETE	<table border="1"> <thead> <tr> <th>Codice</th> <th>Descrizione</th> <th>Qtà</th> <th>UM</th> </tr> </thead> <tbody> <tr> <td>GN1200A1</td> <td>GUARNIZIONE D24 RACCORDO 3/4 SILICONE</td> <td>1</td> <td>PZ</td> </tr> <tr> <td>RC1002A0</td> <td>RIDUZIONE CODOLO 10M-8F</td> <td>1</td> <td>PZ</td> </tr> <tr> <td>RC1365A0</td> <td>RACCORDO JG FEMMINA 3/4"-10</td> <td>1</td> <td>PZ</td> </tr> </tbody> </table>	Codice	Descrizione	Qtà	UM	GN1200A1	GUARNIZIONE D24 RACCORDO 3/4 SILICONE	1	PZ	RC1002A0	RIDUZIONE CODOLO 10M-8F	1	PZ	RC1365A0	RACCORDO JG FEMMINA 3/4"-10	1	PZ								
Codice	Descrizione	Qtà	UM																										
GN1200A1	GUARNIZIONE D24 RACCORDO 3/4 SILICONE	1	PZ																										
RC1002A0	RIDUZIONE CODOLO 10M-8F	1	PZ																										
RC1365A0	RACCORDO JG FEMMINA 3/4"-10	1	PZ																										

COMPONENTE			RICAMBIO																																																						
Codice	Descrizione	Immagine	Codice	Descrizione	Lista componenti																																																				
VL1086A	MAGNETE NEODIMIO ANTICALCARE		KVL1086A	KIT MAGNETE NEODIMIO ANTICALCARE	<table border="1"> <thead> <tr> <th>Codice</th> <th>Descrizione</th> <th>Qtà</th> <th>UM</th> </tr> </thead> <tbody> <tr> <td>VL1086A0</td> <td>MAGNETE NEODIMIO ANTICALCARE</td> <td>2</td> <td>PZ</td> </tr> </tbody> </table>	Codice	Descrizione	Qtà	UM	VL1086A0	MAGNETE NEODIMIO ANTICALCARE	2	PZ																																												
Codice	Descrizione	Qtà	UM																																																						
VL1086A0	MAGNETE NEODIMIO ANTICALCARE	2	PZ																																																						
VM1054A	GHIERA RIDUTTORE DI PRESSIONE H7.8		KVM1054A	KIT GHIERA RIDUTTORE DI PRESSIONE	<table border="1"> <thead> <tr> <th>Codice</th> <th>Descrizione</th> <th>Qtà</th> <th>UM</th> </tr> </thead> <tbody> <tr> <td>VM1054A0</td> <td>GHIERA RIDUTTORE DI PRESSIONE H7.8</td> <td>1</td> <td>PZ</td> </tr> </tbody> </table>	Codice	Descrizione	Qtà	UM	VM1054A0	GHIERA RIDUTTORE DI PRESSIONE H7.8	1	PZ																																												
Codice	Descrizione	Qtà	UM																																																						
VM1054A0	GHIERA RIDUTTORE DI PRESSIONE H7.8	1	PZ																																																						
			KVL1117A	KIT FILTRO+RID. PRESS. EUR MM 2016+LMTOP	<table border="1"> <thead> <tr> <th>Codice</th> <th>Descrizione</th> <th>Qtà</th> <th>UM</th> </tr> </thead> <tbody> <tr> <td>0H7472A1</td> <td>LAMIERA SUPPORTO DISTRIBUTOR</td> <td>1</td> <td>PZ</td> </tr> <tr> <td>RC1004A0</td> <td>RACCORDO Y Ø10-Ø8-8</td> <td>1</td> <td>PZ</td> </tr> <tr> <td>RC1243A0</td> <td>RACCORDO GOMITO CODOLO Ø10F-Ø10M</td> <td>1</td> <td>PZ</td> </tr> <tr> <td>RC1372A0</td> <td>RACCORDO DRITTO Ø10M-1/4 M CI</td> <td>2</td> <td>PZ</td> </tr> <tr> <td>VI1013A1</td> <td>RONDELLA PIANA 30.5X39.5X3 NYLON</td> <td>1</td> <td>PZ</td> </tr> <tr> <td>VI1220A1</td> <td>VITE AUTOFILETTA NTE 4.2X11 TCS+ MARUTE</td> <td>2</td> <td>PZ</td> </tr> <tr> <td>VL1014A0</td> <td>RIDUTTORE DI PRESSIONE CON DISTRIBUTOR</td> <td>1</td> <td>PZ</td> </tr> <tr> <td>VL1014B0</td> <td>RIDUTTORE DI PRESSIONE CON DISTRIBUTOR</td> <td>1</td> <td>PZ</td> </tr> <tr> <td>VL1034C0</td> <td>FILTRO ACQUA D10 MESH100</td> <td>1</td> <td>PZ</td> </tr> <tr> <td>VL1062C0</td> <td>FORCELLA BLOCCA FILTRO-RIDUT TORE PRES.</td> <td>1</td> <td>PZ</td> </tr> <tr> <td>VM1053A0</td> <td>TAPPO 1/8" CIL CON O-RIN</td> <td>2</td> <td>PZ</td> </tr> <tr> <td>VM1054A0</td> <td>GHIERA RIDUTTORE DI PRESSIONE H7.8</td> <td>1</td> <td>PZ</td> </tr> </tbody> </table>	Codice	Descrizione	Qtà	UM	0H7472A1	LAMIERA SUPPORTO DISTRIBUTOR	1	PZ	RC1004A0	RACCORDO Y Ø10-Ø8-8	1	PZ	RC1243A0	RACCORDO GOMITO CODOLO Ø10F-Ø10M	1	PZ	RC1372A0	RACCORDO DRITTO Ø10M-1/4 M CI	2	PZ	VI1013A1	RONDELLA PIANA 30.5X39.5X3 NYLON	1	PZ	VI1220A1	VITE AUTOFILETTA NTE 4.2X11 TCS+ MARUTE	2	PZ	VL1014A0	RIDUTTORE DI PRESSIONE CON DISTRIBUTOR	1	PZ	VL1014B0	RIDUTTORE DI PRESSIONE CON DISTRIBUTOR	1	PZ	VL1034C0	FILTRO ACQUA D10 MESH100	1	PZ	VL1062C0	FORCELLA BLOCCA FILTRO-RIDUT TORE PRES.	1	PZ	VM1053A0	TAPPO 1/8" CIL CON O-RIN	2	PZ	VM1054A0	GHIERA RIDUTTORE DI PRESSIONE H7.8	1	PZ
Codice	Descrizione	Qtà	UM																																																						
0H7472A1	LAMIERA SUPPORTO DISTRIBUTOR	1	PZ																																																						
RC1004A0	RACCORDO Y Ø10-Ø8-8	1	PZ																																																						
RC1243A0	RACCORDO GOMITO CODOLO Ø10F-Ø10M	1	PZ																																																						
RC1372A0	RACCORDO DRITTO Ø10M-1/4 M CI	2	PZ																																																						
VI1013A1	RONDELLA PIANA 30.5X39.5X3 NYLON	1	PZ																																																						
VI1220A1	VITE AUTOFILETTA NTE 4.2X11 TCS+ MARUTE	2	PZ																																																						
VL1014A0	RIDUTTORE DI PRESSIONE CON DISTRIBUTOR	1	PZ																																																						
VL1014B0	RIDUTTORE DI PRESSIONE CON DISTRIBUTOR	1	PZ																																																						
VL1034C0	FILTRO ACQUA D10 MESH100	1	PZ																																																						
VL1062C0	FORCELLA BLOCCA FILTRO-RIDUT TORE PRES.	1	PZ																																																						
VM1053A0	TAPPO 1/8" CIL CON O-RIN	2	PZ																																																						
VM1054A0	GHIERA RIDUTTORE DI PRESSIONE H7.8	1	PZ																																																						

COMPONENTE			RICAMBIO																																																						
Codice	Descrizione	Immagine	Codice	Descrizione	Lista componenti																																																				
VL1034C	FILTRO ACQUA D10 MESH100		KVL1117A	KIT FILTRO+RID. PRESS. EUR MM 2016+LMTOP	<table border="1"> <thead> <tr> <th>Codice</th> <th>Descrizione</th> <th>Qtà</th> <th>UM</th> </tr> </thead> <tbody> <tr> <td>0H7472A1</td> <td>LAMIERA SUPPORTO DISTRIBUTOR</td> <td>1</td> <td>PZ</td> </tr> <tr> <td>RC1004A0</td> <td>RACCORDO Y Ø10-Ø8-8</td> <td>1</td> <td>PZ</td> </tr> <tr> <td>RC1243A0</td> <td>RACCORDO GOMITO CODOLO Ø10F-Ø10M</td> <td>1</td> <td>PZ</td> </tr> <tr> <td>RC1372A0</td> <td>RACCORDO DRITTO Ø10M-1/4 M.CI</td> <td>2</td> <td>PZ</td> </tr> <tr> <td>VI1013A1</td> <td>RONDELLA PIANA 30.5X39.5X3 NYLON</td> <td>1</td> <td>PZ</td> </tr> <tr> <td>VI1220A1</td> <td>VITE AUTOFILETTA NTE 4.2X11 TCS+ MARUTE</td> <td>2</td> <td>PZ</td> </tr> <tr> <td>VL1014A0</td> <td>RIDUTTORE DI PRESSIONE CON DISTRIBUTOR</td> <td>1</td> <td>PZ</td> </tr> <tr> <td>VL1014B0</td> <td>RIDUTTORE DI PRESSIONE CON DISTRIBUTOR</td> <td>1</td> <td>PZ</td> </tr> <tr> <td>VL1034C0</td> <td>FILTRO ACQUA D10 MESH100</td> <td>1</td> <td>PZ</td> </tr> <tr> <td>VL1062C0</td> <td>FORCELLA BLOCCA FILTRO-RIDUT TORE PRES.</td> <td>1</td> <td>PZ</td> </tr> <tr> <td>VM1053A0</td> <td>TAPPO 1/8" CIL CON O-RIN</td> <td>2</td> <td>PZ</td> </tr> <tr> <td>VM1054A0</td> <td>GHIERA RIDUTTORE DI PRESSIONE H7.8</td> <td>1</td> <td>PZ</td> </tr> </tbody> </table>	Codice	Descrizione	Qtà	UM	0H7472A1	LAMIERA SUPPORTO DISTRIBUTOR	1	PZ	RC1004A0	RACCORDO Y Ø10-Ø8-8	1	PZ	RC1243A0	RACCORDO GOMITO CODOLO Ø10F-Ø10M	1	PZ	RC1372A0	RACCORDO DRITTO Ø10M-1/4 M.CI	2	PZ	VI1013A1	RONDELLA PIANA 30.5X39.5X3 NYLON	1	PZ	VI1220A1	VITE AUTOFILETTA NTE 4.2X11 TCS+ MARUTE	2	PZ	VL1014A0	RIDUTTORE DI PRESSIONE CON DISTRIBUTOR	1	PZ	VL1014B0	RIDUTTORE DI PRESSIONE CON DISTRIBUTOR	1	PZ	VL1034C0	FILTRO ACQUA D10 MESH100	1	PZ	VL1062C0	FORCELLA BLOCCA FILTRO-RIDUT TORE PRES.	1	PZ	VM1053A0	TAPPO 1/8" CIL CON O-RIN	2	PZ	VM1054A0	GHIERA RIDUTTORE DI PRESSIONE H7.8	1	PZ
Codice	Descrizione	Qtà	UM																																																						
0H7472A1	LAMIERA SUPPORTO DISTRIBUTOR	1	PZ																																																						
RC1004A0	RACCORDO Y Ø10-Ø8-8	1	PZ																																																						
RC1243A0	RACCORDO GOMITO CODOLO Ø10F-Ø10M	1	PZ																																																						
RC1372A0	RACCORDO DRITTO Ø10M-1/4 M.CI	2	PZ																																																						
VI1013A1	RONDELLA PIANA 30.5X39.5X3 NYLON	1	PZ																																																						
VI1220A1	VITE AUTOFILETTA NTE 4.2X11 TCS+ MARUTE	2	PZ																																																						
VL1014A0	RIDUTTORE DI PRESSIONE CON DISTRIBUTOR	1	PZ																																																						
VL1014B0	RIDUTTORE DI PRESSIONE CON DISTRIBUTOR	1	PZ																																																						
VL1034C0	FILTRO ACQUA D10 MESH100	1	PZ																																																						
VL1062C0	FORCELLA BLOCCA FILTRO-RIDUT TORE PRES.	1	PZ																																																						
VM1053A0	TAPPO 1/8" CIL CON O-RIN	2	PZ																																																						
VM1054A0	GHIERA RIDUTTORE DI PRESSIONE H7.8	1	PZ																																																						
			KVL1034C	KIT RICAMBIO FILTRO ACQUA Ø8-Ø10 MESH100	<table border="1"> <thead> <tr> <th>Codice</th> <th>Descrizione</th> <th>Qtà</th> <th>UM</th> </tr> </thead> <tbody> <tr> <td>RC1002A0</td> <td>RACCORDO RIDUZIONE CODOLO 10M-8F</td> <td>2</td> <td>PZ</td> </tr> <tr> <td>VL1034C0</td> <td>FILTRO ACQUA D10 MESH100</td> <td>1</td> <td>PZ</td> </tr> <tr> <td>VL1062C0</td> <td>FORCELLA BLOCCA FILTRO-RIDUT TORE PRES.</td> <td>1</td> <td>PZ</td> </tr> </tbody> </table>	Codice	Descrizione	Qtà	UM	RC1002A0	RACCORDO RIDUZIONE CODOLO 10M-8F	2	PZ	VL1034C0	FILTRO ACQUA D10 MESH100	1	PZ	VL1062C0	FORCELLA BLOCCA FILTRO-RIDUT TORE PRES.	1	PZ																																				
Codice	Descrizione	Qtà	UM																																																						
RC1002A0	RACCORDO RIDUZIONE CODOLO 10M-8F	2	PZ																																																						
VL1034C0	FILTRO ACQUA D10 MESH100	1	PZ																																																						
VL1062C0	FORCELLA BLOCCA FILTRO-RIDUT TORE PRES.	1	PZ																																																						

COMPONENTE			RICAMBIO																																																						
Codice	Descrizione	Immagine	Codice	Descrizione	Lista componenti																																																				
VL1062C	FORCELLA BLOCCA FILTRO-RIDUTTORE PRES.		KVL1117A	KIT FILTRO+RID. PRESS. EUR MM 2016+LMTOP	<table border="1"> <thead> <tr> <th>Codice</th> <th>Descrizione</th> <th>Qtà</th> <th>UM</th> </tr> </thead> <tbody> <tr> <td>0H7472A1</td> <td>LAMIERA SUPPORTO DISTRIBUTOR</td> <td>1</td> <td>PZ</td> </tr> <tr> <td>RC1004A0</td> <td>RACCORDO Y Ø10-Ø8-8</td> <td>1</td> <td>PZ</td> </tr> <tr> <td>RC1243A0</td> <td>RACCORDO GOMITO CODOLO Ø10F-Ø10M</td> <td>1</td> <td>PZ</td> </tr> <tr> <td>RC1372A0</td> <td>RACCORDO DRITTO Ø10M-1/4 M CI</td> <td>2</td> <td>PZ</td> </tr> <tr> <td>VI1013A1</td> <td>RONDELLA PIANA 30.5X39.5X3 NYLON</td> <td>1</td> <td>PZ</td> </tr> <tr> <td>VI1220A1</td> <td>VITE AUTOFILETTA NTE 4.2X11 TCS+ MARUTE</td> <td>2</td> <td>PZ</td> </tr> <tr> <td>VL1014A0</td> <td>RIDUTTORE DI PRESSIONE CON DISTRIBUTOR</td> <td>1</td> <td>PZ</td> </tr> <tr> <td>VL1014B0</td> <td>RIDUTTORE DI PRESSIONE CON DISTRIBUTOR</td> <td>1</td> <td>PZ</td> </tr> <tr> <td>VL1034C0</td> <td>FILTRO ACQUA D10 MESH100</td> <td>1</td> <td>PZ</td> </tr> <tr> <td>VL1062C0</td> <td>FORCELLA BLOCCA FILTRO-RIDUT TORE PRES.</td> <td>1</td> <td>PZ</td> </tr> <tr> <td>VM1053A0</td> <td>TAPPO 1/8" CIL CON O-RIN</td> <td>2</td> <td>PZ</td> </tr> <tr> <td>VM1054A0</td> <td>GHIERA RIDUTTORE DI PRESSIONE H7.8</td> <td>1</td> <td>PZ</td> </tr> </tbody> </table>	Codice	Descrizione	Qtà	UM	0H7472A1	LAMIERA SUPPORTO DISTRIBUTOR	1	PZ	RC1004A0	RACCORDO Y Ø10-Ø8-8	1	PZ	RC1243A0	RACCORDO GOMITO CODOLO Ø10F-Ø10M	1	PZ	RC1372A0	RACCORDO DRITTO Ø10M-1/4 M CI	2	PZ	VI1013A1	RONDELLA PIANA 30.5X39.5X3 NYLON	1	PZ	VI1220A1	VITE AUTOFILETTA NTE 4.2X11 TCS+ MARUTE	2	PZ	VL1014A0	RIDUTTORE DI PRESSIONE CON DISTRIBUTOR	1	PZ	VL1014B0	RIDUTTORE DI PRESSIONE CON DISTRIBUTOR	1	PZ	VL1034C0	FILTRO ACQUA D10 MESH100	1	PZ	VL1062C0	FORCELLA BLOCCA FILTRO-RIDUT TORE PRES.	1	PZ	VM1053A0	TAPPO 1/8" CIL CON O-RIN	2	PZ	VM1054A0	GHIERA RIDUTTORE DI PRESSIONE H7.8	1	PZ
Codice	Descrizione	Qtà	UM																																																						
0H7472A1	LAMIERA SUPPORTO DISTRIBUTOR	1	PZ																																																						
RC1004A0	RACCORDO Y Ø10-Ø8-8	1	PZ																																																						
RC1243A0	RACCORDO GOMITO CODOLO Ø10F-Ø10M	1	PZ																																																						
RC1372A0	RACCORDO DRITTO Ø10M-1/4 M CI	2	PZ																																																						
VI1013A1	RONDELLA PIANA 30.5X39.5X3 NYLON	1	PZ																																																						
VI1220A1	VITE AUTOFILETTA NTE 4.2X11 TCS+ MARUTE	2	PZ																																																						
VL1014A0	RIDUTTORE DI PRESSIONE CON DISTRIBUTOR	1	PZ																																																						
VL1014B0	RIDUTTORE DI PRESSIONE CON DISTRIBUTOR	1	PZ																																																						
VL1034C0	FILTRO ACQUA D10 MESH100	1	PZ																																																						
VL1062C0	FORCELLA BLOCCA FILTRO-RIDUT TORE PRES.	1	PZ																																																						
VM1053A0	TAPPO 1/8" CIL CON O-RIN	2	PZ																																																						
VM1054A0	GHIERA RIDUTTORE DI PRESSIONE H7.8	1	PZ																																																						
0H7472A	LAMIERA SUPPORTO DISTRIBUTORE		KVL1117A	KIT FILTRO+RID. PRESS. EUR MM 2016+LMTOP	<table border="1"> <thead> <tr> <th>Codice</th> <th>Descrizione</th> <th>Qtà</th> <th>UM</th> </tr> </thead> <tbody> <tr> <td>0H7472A1</td> <td>LAMIERA SUPPORTO DISTRIBUTOR</td> <td>1</td> <td>PZ</td> </tr> <tr> <td>RC1004A0</td> <td>RACCORDO Y Ø10-Ø8-8</td> <td>1</td> <td>PZ</td> </tr> <tr> <td>RC1243A0</td> <td>RACCORDO GOMITO CODOLO Ø10F-Ø10M</td> <td>1</td> <td>PZ</td> </tr> <tr> <td>RC1372A0</td> <td>RACCORDO DRITTO Ø10M-1/4 M CI</td> <td>2</td> <td>PZ</td> </tr> </tbody> </table>	Codice	Descrizione	Qtà	UM	0H7472A1	LAMIERA SUPPORTO DISTRIBUTOR	1	PZ	RC1004A0	RACCORDO Y Ø10-Ø8-8	1	PZ	RC1243A0	RACCORDO GOMITO CODOLO Ø10F-Ø10M	1	PZ	RC1372A0	RACCORDO DRITTO Ø10M-1/4 M CI	2	PZ																																
Codice	Descrizione	Qtà	UM																																																						
0H7472A1	LAMIERA SUPPORTO DISTRIBUTOR	1	PZ																																																						
RC1004A0	RACCORDO Y Ø10-Ø8-8	1	PZ																																																						
RC1243A0	RACCORDO GOMITO CODOLO Ø10F-Ø10M	1	PZ																																																						
RC1372A0	RACCORDO DRITTO Ø10M-1/4 M CI	2	PZ																																																						



COMPONENTE			RICAMBIO																																						
Codice	Descrizione	Immagine	Codice	Descrizione	Lista componenti																																				
0H7472A	LAMIERA SUPPORTO DISTRIBUTORE		KVL1117A	KIT FILTRO+RID. PRESS. EUR MM 2016+LMTOP	<table border="1"> <thead> <tr> <th>Codice</th> <th>Descrizione</th> <th>Qtà</th> <th>UM</th> </tr> </thead> <tbody> <tr> <td>VI1013A1</td> <td>RONDELLA PIANA 30.5X39.5X3 NYLON</td> <td>1</td> <td>PZ</td> </tr> <tr> <td>VI1220A1</td> <td>VITE AUTOFILETTA NTE 4.2X11 TCS+ MARUTE</td> <td>2</td> <td>PZ</td> </tr> <tr> <td>VL1014A0</td> <td>RIDUTTORE DI PRESSIONE CON DISTRIBUTOR</td> <td>1</td> <td>PZ</td> </tr> <tr> <td>VL1014B0</td> <td>RIDUTTORE DI PRESSIONE CON DISTRIBUTOR</td> <td>1</td> <td>PZ</td> </tr> <tr> <td>VL1034C0</td> <td>FILTRO ACQUA D10 MESH100</td> <td>1</td> <td>PZ</td> </tr> <tr> <td>VL1062C0</td> <td>FORCELLA BLOCCA FILTRO-RIDUT TORE PRES.</td> <td>1</td> <td>PZ</td> </tr> <tr> <td>VM1053A0</td> <td>TAPPO 1/8" CIL CON O-RIN</td> <td>2</td> <td>PZ</td> </tr> <tr> <td>VM1054A0</td> <td>GHIERA RIDUTTORE DI PRESSIONE H7.8</td> <td>1</td> <td>PZ</td> </tr> </tbody> </table>	Codice	Descrizione	Qtà	UM	VI1013A1	RONDELLA PIANA 30.5X39.5X3 NYLON	1	PZ	VI1220A1	VITE AUTOFILETTA NTE 4.2X11 TCS+ MARUTE	2	PZ	VL1014A0	RIDUTTORE DI PRESSIONE CON DISTRIBUTOR	1	PZ	VL1014B0	RIDUTTORE DI PRESSIONE CON DISTRIBUTOR	1	PZ	VL1034C0	FILTRO ACQUA D10 MESH100	1	PZ	VL1062C0	FORCELLA BLOCCA FILTRO-RIDUT TORE PRES.	1	PZ	VM1053A0	TAPPO 1/8" CIL CON O-RIN	2	PZ	VM1054A0	GHIERA RIDUTTORE DI PRESSIONE H7.8	1	PZ
			Codice	Descrizione	Qtà	UM																																			
VI1013A1	RONDELLA PIANA 30.5X39.5X3 NYLON	1	PZ																																						
VI1220A1	VITE AUTOFILETTA NTE 4.2X11 TCS+ MARUTE	2	PZ																																						
VL1014A0	RIDUTTORE DI PRESSIONE CON DISTRIBUTOR	1	PZ																																						
VL1014B0	RIDUTTORE DI PRESSIONE CON DISTRIBUTOR	1	PZ																																						
VL1034C0	FILTRO ACQUA D10 MESH100	1	PZ																																						
VL1062C0	FORCELLA BLOCCA FILTRO-RIDUT TORE PRES.	1	PZ																																						
VM1053A0	TAPPO 1/8" CIL CON O-RIN	2	PZ																																						
VM1054A0	GHIERA RIDUTTORE DI PRESSIONE H7.8	1	PZ																																						
K0H7472A	KIT LAMIERA SUPPORTO DISTRIBUTORE	<table border="1"> <thead> <tr> <th>Codice</th> <th>Descrizione</th> <th>Qtà</th> <th>UM</th> </tr> </thead> <tbody> <tr> <td>0H7472A0</td> <td>LAMIERA SUPPORTO DISTRIBUTOR</td> <td>1</td> <td>PZ</td> </tr> <tr> <td>0H7472A1</td> <td>LAMIERA SUPPORTO DISTRIBUTOR</td> <td>1</td> <td>PZ</td> </tr> </tbody> </table>	Codice	Descrizione	Qtà	UM	0H7472A0	LAMIERA SUPPORTO DISTRIBUTOR	1	PZ	0H7472A1	LAMIERA SUPPORTO DISTRIBUTOR	1	PZ																											
Codice	Descrizione	Qtà	UM																																						
0H7472A0	LAMIERA SUPPORTO DISTRIBUTOR	1	PZ																																						
0H7472A1	LAMIERA SUPPORTO DISTRIBUTOR	1	PZ																																						
VL1125A	RACCORDO CURVO M-M PORTAGOMMA D8- CODOLO		KVL1125A	KIT 10PZ RAC CURVO M-M PORTAG D8-COD D1	<table border="1"> <thead> <tr> <th>Codice</th> <th>Descrizione</th> <th>Qtà</th> <th>UM</th> </tr> </thead> <tbody> <tr> <td>VL1125A0</td> <td>RACCORDO CURVO M-M PORTAGOMM A D8- CODOLO</td> <td>10</td> <td>PZ</td> </tr> </tbody> </table>	Codice	Descrizione	Qtà	UM	VL1125A0	RACCORDO CURVO M-M PORTAGOMM A D8- CODOLO	10	PZ																												
Codice	Descrizione	Qtà	UM																																						
VL1125A0	RACCORDO CURVO M-M PORTAGOMM A D8- CODOLO	10	PZ																																						

COMPONENTE			RICAMBIO																																																						
Codice	Descrizione	Immagine	Codice	Descrizione	Lista componenti																																																				
RC1372A	RACCORDO DRITTO Ø10M-1/4 M CIL		KVL1117A	KIT FILTRO+RID. PRESS. EUR MM 2016+LMTOP	<table border="1"> <thead> <tr> <th>Codice</th> <th>Descrizione</th> <th>Qtà</th> <th>UM</th> </tr> </thead> <tbody> <tr> <td>0H7472A1</td> <td>LAMIERA SUPPORTO DISTRIBUTOR</td> <td>1</td> <td>PZ</td> </tr> <tr> <td>RC1004A0</td> <td>RACCORDO Y Ø10-Ø8-8</td> <td>1</td> <td>PZ</td> </tr> <tr> <td>RC1243A0</td> <td>RACCORDO GOMITO CODOLO Ø10F-Ø10M</td> <td>1</td> <td>PZ</td> </tr> <tr> <td>RC1372A0</td> <td>RACCORDO DRITTO Ø10M-1/4 M CI</td> <td>2</td> <td>PZ</td> </tr> <tr> <td>VI1013A1</td> <td>RONDELLA PIANA 30.5X39.5X3 NYLON</td> <td>1</td> <td>PZ</td> </tr> <tr> <td>VI1220A1</td> <td>VITE AUTOFILETTA NTE 4.2X11 TCS+ MARUTE</td> <td>2</td> <td>PZ</td> </tr> <tr> <td>VL1014A0</td> <td>RIDUTTORE DI PRESSIONE CON DISTRIBUTOR</td> <td>1</td> <td>PZ</td> </tr> <tr> <td>VL1014B0</td> <td>RIDUTTORE DI PRESSIONE CON DISTRIBUTOR</td> <td>1</td> <td>PZ</td> </tr> <tr> <td>VL1034C0</td> <td>FILTRO ACQUA D10 MESH100</td> <td>1</td> <td>PZ</td> </tr> <tr> <td>VL1062C0</td> <td>FORCELLA BLOCCA FILTRO-RIDUT TORE PRES.</td> <td>1</td> <td>PZ</td> </tr> <tr> <td>VM1053A0</td> <td>TAPPO 1/8" CIL CON O-RIN</td> <td>2</td> <td>PZ</td> </tr> <tr> <td>VM1054A0</td> <td>GHIERA RIDUTTORE DI PRESSIONE H7.8</td> <td>1</td> <td>PZ</td> </tr> </tbody> </table>	Codice	Descrizione	Qtà	UM	0H7472A1	LAMIERA SUPPORTO DISTRIBUTOR	1	PZ	RC1004A0	RACCORDO Y Ø10-Ø8-8	1	PZ	RC1243A0	RACCORDO GOMITO CODOLO Ø10F-Ø10M	1	PZ	RC1372A0	RACCORDO DRITTO Ø10M-1/4 M CI	2	PZ	VI1013A1	RONDELLA PIANA 30.5X39.5X3 NYLON	1	PZ	VI1220A1	VITE AUTOFILETTA NTE 4.2X11 TCS+ MARUTE	2	PZ	VL1014A0	RIDUTTORE DI PRESSIONE CON DISTRIBUTOR	1	PZ	VL1014B0	RIDUTTORE DI PRESSIONE CON DISTRIBUTOR	1	PZ	VL1034C0	FILTRO ACQUA D10 MESH100	1	PZ	VL1062C0	FORCELLA BLOCCA FILTRO-RIDUT TORE PRES.	1	PZ	VM1053A0	TAPPO 1/8" CIL CON O-RIN	2	PZ	VM1054A0	GHIERA RIDUTTORE DI PRESSIONE H7.8	1	PZ
Codice	Descrizione	Qtà	UM																																																						
0H7472A1	LAMIERA SUPPORTO DISTRIBUTOR	1	PZ																																																						
RC1004A0	RACCORDO Y Ø10-Ø8-8	1	PZ																																																						
RC1243A0	RACCORDO GOMITO CODOLO Ø10F-Ø10M	1	PZ																																																						
RC1372A0	RACCORDO DRITTO Ø10M-1/4 M CI	2	PZ																																																						
VI1013A1	RONDELLA PIANA 30.5X39.5X3 NYLON	1	PZ																																																						
VI1220A1	VITE AUTOFILETTA NTE 4.2X11 TCS+ MARUTE	2	PZ																																																						
VL1014A0	RIDUTTORE DI PRESSIONE CON DISTRIBUTOR	1	PZ																																																						
VL1014B0	RIDUTTORE DI PRESSIONE CON DISTRIBUTOR	1	PZ																																																						
VL1034C0	FILTRO ACQUA D10 MESH100	1	PZ																																																						
VL1062C0	FORCELLA BLOCCA FILTRO-RIDUT TORE PRES.	1	PZ																																																						
VM1053A0	TAPPO 1/8" CIL CON O-RIN	2	PZ																																																						
VM1054A0	GHIERA RIDUTTORE DI PRESSIONE H7.8	1	PZ																																																						
			KRC1372A	KIT RACCORDO DRITTO D 10M-1/4 M CIL	<table border="1"> <thead> <tr> <th>Codice</th> <th>Descrizione</th> <th>Qtà</th> <th>UM</th> </tr> </thead> <tbody> <tr> <td>RC1372A0</td> <td>RACCORDO DRITTO Ø10M-1/4 M CI</td> <td>1</td> <td>PZ</td> </tr> </tbody> </table>	Codice	Descrizione	Qtà	UM	RC1372A0	RACCORDO DRITTO Ø10M-1/4 M CI	1	PZ																																												
Codice	Descrizione	Qtà	UM																																																						
RC1372A0	RACCORDO DRITTO Ø10M-1/4 M CI	1	PZ																																																						

COMPONENTE			RICAMBIO																																																																													
Codice	Descrizione	Immagine	Codice	Descrizione	Lista componenti																																																																											
VL1014B	RIDUTTORE DI PRESSIONE CON DISTRIBUTORE		KVL1117A	KIT FILTRO+RID. PRESS. EUR MM 2016+LMTOP	<table border="1"> <thead> <tr> <th>Codice</th> <th>Descrizione</th> <th>Qtà</th> <th>UM</th> </tr> </thead> <tbody> <tr> <td>0H7472A1</td> <td>LAMIERA SUPPORTO DISTRIBUTOR</td> <td>1</td> <td>PZ</td> </tr> <tr> <td>RC1004A0</td> <td>RACCORDO Y Ø10-Ø8-8</td> <td>1</td> <td>PZ</td> </tr> <tr> <td>RC1243A0</td> <td>RACCORDO GOMITO CODOLO Ø10F-Ø10M</td> <td>1</td> <td>PZ</td> </tr> <tr> <td>RC1372A0</td> <td>RACCORDO DRITTO Ø10M-1/4 M.CI</td> <td>2</td> <td>PZ</td> </tr> <tr> <td>VI1013A1</td> <td>RONDELLA PIANA 30.5X39.5X3 NYLON</td> <td>1</td> <td>PZ</td> </tr> <tr> <td>VI1220A1</td> <td>VITE AUTOFILETTA NTE 4.2X11 TCS+ MARUTE</td> <td>2</td> <td>PZ</td> </tr> <tr> <td>VL1014A0</td> <td>RIDUTTORE DI PRESSIONE CON DISTRIBUTOR</td> <td>1</td> <td>PZ</td> </tr> <tr> <td>VL1014B0</td> <td>RIDUTTORE DI PRESSIONE CON DISTRIBUTOR</td> <td>1</td> <td>PZ</td> </tr> <tr> <td>VL1034C0</td> <td>FILTRO ACQUA D10 MESH100</td> <td>1</td> <td>PZ</td> </tr> <tr> <td>VL1062C0</td> <td>FORCELLA BLOCCA FILTRO-RIDUTTORE PRES.</td> <td>1</td> <td>PZ</td> </tr> <tr> <td>VM1053A0</td> <td>TAPPO 1/8" CIL CON O-RIN</td> <td>2</td> <td>PZ</td> </tr> <tr> <td>VM1054A0</td> <td>GHIERA RIDUTTORE DI PRESSIONE H7.8</td> <td>1</td> <td>PZ</td> </tr> </tbody> </table>	Codice	Descrizione	Qtà	UM	0H7472A1	LAMIERA SUPPORTO DISTRIBUTOR	1	PZ	RC1004A0	RACCORDO Y Ø10-Ø8-8	1	PZ	RC1243A0	RACCORDO GOMITO CODOLO Ø10F-Ø10M	1	PZ	RC1372A0	RACCORDO DRITTO Ø10M-1/4 M.CI	2	PZ	VI1013A1	RONDELLA PIANA 30.5X39.5X3 NYLON	1	PZ	VI1220A1	VITE AUTOFILETTA NTE 4.2X11 TCS+ MARUTE	2	PZ	VL1014A0	RIDUTTORE DI PRESSIONE CON DISTRIBUTOR	1	PZ	VL1014B0	RIDUTTORE DI PRESSIONE CON DISTRIBUTOR	1	PZ	VL1034C0	FILTRO ACQUA D10 MESH100	1	PZ	VL1062C0	FORCELLA BLOCCA FILTRO-RIDUTTORE PRES.	1	PZ	VM1053A0	TAPPO 1/8" CIL CON O-RIN	2	PZ	VM1054A0	GHIERA RIDUTTORE DI PRESSIONE H7.8	1	PZ	KVL1014B	KIT RIDUTTORE DI PRESSIONE EURO MM	<table border="1"> <thead> <tr> <th>Codice</th> <th>Descrizione</th> <th>Qtà</th> <th>UM</th> </tr> </thead> <tbody> <tr> <td>EL1185A0</td> <td>RACCORDO A GOMITO J.GUEST Ø8F - Ø8F</td> <td>1</td> <td>PZ</td> </tr> <tr> <td>RC1003A0</td> <td>RACCORDO 8M-1/8 BSPP</td> <td>2</td> <td>PZ</td> </tr> <tr> <td>RC1372A0</td> <td>RACCORDO DRITTO Ø10M-1/4 M.CI</td> <td>1</td> <td>PZ</td> </tr> <tr> <td>RC1396A0</td> <td>TERMINALE DRITTO JG D10-1/4</td> <td>1</td> <td>PZ</td> </tr> </tbody> </table>	Codice	Descrizione	Qtà	UM	EL1185A0	RACCORDO A GOMITO J.GUEST Ø8F - Ø8F	1	PZ	RC1003A0	RACCORDO 8M-1/8 BSPP	2	PZ	RC1372A0	RACCORDO DRITTO Ø10M-1/4 M.CI	1	PZ	RC1396A0	TERMINALE DRITTO JG D10-1/4	1	PZ
			Codice	Descrizione	Qtà	UM																																																																										
0H7472A1	LAMIERA SUPPORTO DISTRIBUTOR	1	PZ																																																																													
RC1004A0	RACCORDO Y Ø10-Ø8-8	1	PZ																																																																													
RC1243A0	RACCORDO GOMITO CODOLO Ø10F-Ø10M	1	PZ																																																																													
RC1372A0	RACCORDO DRITTO Ø10M-1/4 M.CI	2	PZ																																																																													
VI1013A1	RONDELLA PIANA 30.5X39.5X3 NYLON	1	PZ																																																																													
VI1220A1	VITE AUTOFILETTA NTE 4.2X11 TCS+ MARUTE	2	PZ																																																																													
VL1014A0	RIDUTTORE DI PRESSIONE CON DISTRIBUTOR	1	PZ																																																																													
VL1014B0	RIDUTTORE DI PRESSIONE CON DISTRIBUTOR	1	PZ																																																																													
VL1034C0	FILTRO ACQUA D10 MESH100	1	PZ																																																																													
VL1062C0	FORCELLA BLOCCA FILTRO-RIDUTTORE PRES.	1	PZ																																																																													
VM1053A0	TAPPO 1/8" CIL CON O-RIN	2	PZ																																																																													
VM1054A0	GHIERA RIDUTTORE DI PRESSIONE H7.8	1	PZ																																																																													
Codice	Descrizione	Qtà	UM																																																																													
EL1185A0	RACCORDO A GOMITO J.GUEST Ø8F - Ø8F	1	PZ																																																																													
RC1003A0	RACCORDO 8M-1/8 BSPP	2	PZ																																																																													
RC1372A0	RACCORDO DRITTO Ø10M-1/4 M.CI	1	PZ																																																																													
RC1396A0	TERMINALE DRITTO JG D10-1/4	1	PZ																																																																													



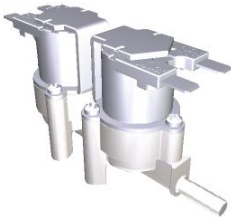
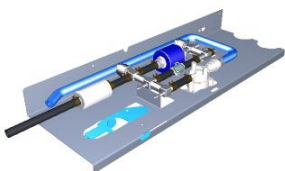

COMPONENTE			RICAMBIO																										
Codice	Descrizione	Immagine	Codice	Descrizione	Lista componenti																								
VL1014B	RIDUTTORE DI PRESSIONE CON DISTRIBUTORE		KVL1014B	KIT RIDUTTORE DI PRESSIONE EURO MM	<table border="1"> <thead> <tr> <th>Codice</th> <th>Descrizione</th> <th>Qtà</th> <th>UM</th> </tr> </thead> <tbody> <tr> <td>VL1014B0</td> <td>RIDUTTORE DI PRESSIONE CON DISTRIBUTOR</td> <td>1</td> <td>PZ</td> </tr> <tr> <td>VL1071A0</td> <td>RIDUTTORE DI PRESSIONE CON DISTRIBUTOR</td> <td>1</td> <td>PZ</td> </tr> <tr> <td>VM1054A0</td> <td>GHIERA RIDUTTORE DI PRESSIONE H7.8</td> <td>1</td> <td>PZ</td> </tr> <tr> <td>VM2028A0</td> <td>RONDELLA GOMMA 20X10X4</td> <td>1</td> <td>PZ</td> </tr> <tr> <td>VM2059A0</td> <td>TAPPO 1/4" CIL CON O-RING*</td> <td>1</td> <td>PZ</td> </tr> </tbody> </table>	Codice	Descrizione	Qtà	UM	VL1014B0	RIDUTTORE DI PRESSIONE CON DISTRIBUTOR	1	PZ	VL1071A0	RIDUTTORE DI PRESSIONE CON DISTRIBUTOR	1	PZ	VM1054A0	GHIERA RIDUTTORE DI PRESSIONE H7.8	1	PZ	VM2028A0	RONDELLA GOMMA 20X10X4	1	PZ	VM2059A0	TAPPO 1/4" CIL CON O-RING*	1	PZ
			Codice	Descrizione	Qtà	UM																							
			VL1014B0	RIDUTTORE DI PRESSIONE CON DISTRIBUTOR	1	PZ																							
VL1071A0	RIDUTTORE DI PRESSIONE CON DISTRIBUTOR	1	PZ																										
VM1054A0	GHIERA RIDUTTORE DI PRESSIONE H7.8	1	PZ																										
VM2028A0	RONDELLA GOMMA 20X10X4	1	PZ																										
VM2059A0	TAPPO 1/4" CIL CON O-RING*	1	PZ																										
KVL0014B	KIT RIDUTTORE PRESSIONE MM EUR V2 2017	<table border="1"> <thead> <tr> <th>Codice</th> <th>Descrizione</th> <th>Qtà</th> <th>UM</th> </tr> </thead> <tbody> <tr> <td>RC1372A0</td> <td>RACCORDO DRITTO Ø10M-1/4 M.CI</td> <td>1</td> <td>PZ</td> </tr> <tr> <td>RC1396A0</td> <td>TERMINALE DRITTO JG D10-1/4</td> <td>1</td> <td>PZ</td> </tr> <tr> <td>VL1014B0</td> <td>RIDUTTORE DI PRESSIONE CON DISTRIBUTOR</td> <td>1</td> <td>PZ</td> </tr> <tr> <td>VM1054A0</td> <td>GHIERA RIDUTTORE DI PRESSIONE H7.8</td> <td>1</td> <td>PZ</td> </tr> </tbody> </table>	Codice	Descrizione	Qtà	UM	RC1372A0	RACCORDO DRITTO Ø10M-1/4 M.CI	1	PZ	RC1396A0	TERMINALE DRITTO JG D10-1/4	1	PZ	VL1014B0	RIDUTTORE DI PRESSIONE CON DISTRIBUTOR	1	PZ	VM1054A0	GHIERA RIDUTTORE DI PRESSIONE H7.8	1	PZ							
Codice	Descrizione	Qtà	UM																										
RC1372A0	RACCORDO DRITTO Ø10M-1/4 M.CI	1	PZ																										
RC1396A0	TERMINALE DRITTO JG D10-1/4	1	PZ																										
VL1014B0	RIDUTTORE DI PRESSIONE CON DISTRIBUTOR	1	PZ																										
VM1054A0	GHIERA RIDUTTORE DI PRESSIONE H7.8	1	PZ																										
KVL0014A	KIT RIDUTTORE DI PRESSIONE MIND.MAPS EUR	<table border="1"> <thead> <tr> <th>Codice</th> <th>Descrizione</th> <th>Qtà</th> <th>UM</th> </tr> </thead> <tbody> <tr> <td>RC1372A0</td> <td>RACCORDO DRITTO Ø10M-1/4 M.CI</td> <td>2</td> <td>PZ</td> </tr> <tr> <td>VL1014A0</td> <td>RIDUTTORE DI PRESSIONE CON DISTRIBUTOR</td> <td>1</td> <td>PZ</td> </tr> <tr> <td>VL1014B0</td> <td>RIDUTTORE DI PRESSIONE CON DISTRIBUTOR</td> <td>1</td> <td>PZ</td> </tr> <tr> <td>VM1053A0</td> <td>TAPPO 1/8" CIL CON O-RIN</td> <td>2</td> <td>PZ</td> </tr> <tr> <td>VM1054A0</td> <td>GHIERA RIDUTTORE DI PRESSIONE H7.8</td> <td>1</td> <td>PZ</td> </tr> </tbody> </table>	Codice	Descrizione	Qtà	UM	RC1372A0	RACCORDO DRITTO Ø10M-1/4 M.CI	2	PZ	VL1014A0	RIDUTTORE DI PRESSIONE CON DISTRIBUTOR	1	PZ	VL1014B0	RIDUTTORE DI PRESSIONE CON DISTRIBUTOR	1	PZ	VM1053A0	TAPPO 1/8" CIL CON O-RIN	2	PZ	VM1054A0	GHIERA RIDUTTORE DI PRESSIONE H7.8	1	PZ			
Codice	Descrizione	Qtà	UM																										
RC1372A0	RACCORDO DRITTO Ø10M-1/4 M.CI	2	PZ																										
VL1014A0	RIDUTTORE DI PRESSIONE CON DISTRIBUTOR	1	PZ																										
VL1014B0	RIDUTTORE DI PRESSIONE CON DISTRIBUTOR	1	PZ																										
VM1053A0	TAPPO 1/8" CIL CON O-RIN	2	PZ																										
VM1054A0	GHIERA RIDUTTORE DI PRESSIONE H7.8	1	PZ																										

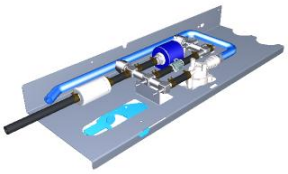
COMPONENTE			RICAMBIO																						
Codice	Descrizione	Immagine	Codice	Descrizione	Lista componenti																				
VL1014B	RIDUTTORE DI PRESSIONE CON DISTRIBUTORE		KVL0010A	KIT RIDUTTORE DI PRESSIONE SERIE 4 E 5	<table border="1"> <thead> <tr> <th>Codice</th> <th>Descrizione</th> <th>Qtà</th> <th>UM</th> </tr> </thead> <tbody> <tr> <td>EL1210A0</td> <td>RACCORDO J.GUEST TERMINALE DIRITTO</td> <td>2</td> <td>PZ</td> </tr> <tr> <td>VL1014A0</td> <td>RIDUTTORE DI PRESSIONE CON DISTRIBUTOR</td> <td>1</td> <td>PZ</td> </tr> <tr> <td>VL1014B0</td> <td>RIDUTTORE DI PRESSIONE CON DISTRIBUTOR</td> <td>1</td> <td>PZ</td> </tr> <tr> <td>VM1053A0</td> <td>TAPPO 1/8" CIL CON O-RIN</td> <td>2</td> <td>PZ</td> </tr> </tbody> </table>	Codice	Descrizione	Qtà	UM	EL1210A0	RACCORDO J.GUEST TERMINALE DIRITTO	2	PZ	VL1014A0	RIDUTTORE DI PRESSIONE CON DISTRIBUTOR	1	PZ	VL1014B0	RIDUTTORE DI PRESSIONE CON DISTRIBUTOR	1	PZ	VM1053A0	TAPPO 1/8" CIL CON O-RIN	2	PZ
					Codice	Descrizione	Qtà	UM																	
					EL1210A0	RACCORDO J.GUEST TERMINALE DIRITTO	2	PZ																	
					VL1014A0	RIDUTTORE DI PRESSIONE CON DISTRIBUTOR	1	PZ																	
VL1014B0	RIDUTTORE DI PRESSIONE CON DISTRIBUTOR	1	PZ																						
VM1053A0	TAPPO 1/8" CIL CON O-RIN	2	PZ																						
<table border="1"> <thead> <tr> <th>Codice</th> <th>Descrizione</th> <th>Qtà</th> <th>UM</th> </tr> </thead> <tbody> <tr> <td>RC1372A0</td> <td>RACCORDO DRITTO Ø10M-1/4 M CI</td> <td>1</td> <td>PZ</td> </tr> <tr> <td>RC1396A0</td> <td>TERMINALE DRITTO JG D10-1/4</td> <td>1</td> <td>PZ</td> </tr> <tr> <td>VL1014B0</td> <td>RIDUTTORE DI PRESSIONE CON DISTRIBUTOR</td> <td>1</td> <td>PZ</td> </tr> <tr> <td>VM1054A0</td> <td>GHIERA RIDUTTORE DI PRESSIONE H7.8</td> <td>1</td> <td>PZ</td> </tr> </tbody> </table>	Codice	Descrizione	Qtà	UM	RC1372A0	RACCORDO DRITTO Ø10M-1/4 M CI	1	PZ	RC1396A0	TERMINALE DRITTO JG D10-1/4	1	PZ	VL1014B0	RIDUTTORE DI PRESSIONE CON DISTRIBUTOR	1	PZ	VM1054A0	GHIERA RIDUTTORE DI PRESSIONE H7.8	1	PZ					
Codice	Descrizione	Qtà	UM																						
RC1372A0	RACCORDO DRITTO Ø10M-1/4 M CI	1	PZ																						
RC1396A0	TERMINALE DRITTO JG D10-1/4	1	PZ																						
VL1014B0	RIDUTTORE DI PRESSIONE CON DISTRIBUTOR	1	PZ																						
VM1054A0	GHIERA RIDUTTORE DI PRESSIONE H7.8	1	PZ																						
<table border="1"> <thead> <tr> <th>Codice</th> <th>Descrizione</th> <th>Qtà</th> <th>UM</th> </tr> </thead> <tbody> <tr> <td>VL1125A0</td> <td>RACCORDO CURVO M-M PORTAGOMM A D8- CODOLO</td> <td>10</td> <td>PZ</td> </tr> </tbody> </table>	Codice	Descrizione	Qtà	UM	VL1125A0	RACCORDO CURVO M-M PORTAGOMM A D8- CODOLO	10	PZ																	
Codice	Descrizione	Qtà	UM																						
VL1125A0	RACCORDO CURVO M-M PORTAGOMM A D8- CODOLO	10	PZ																						
<table border="1"> <thead> <tr> <th>Codice</th> <th>Descrizione</th> <th>Qtà</th> <th>UM</th> </tr> </thead> <tbody> <tr> <td>VL1063A0</td> <td>PORTAGOMM A D8 CODOLO D10</td> <td>10</td> <td>PZ</td> </tr> </tbody> </table>	Codice	Descrizione	Qtà	UM	VL1063A0	PORTAGOMM A D8 CODOLO D10	10	PZ																	
Codice	Descrizione	Qtà	UM																						
VL1063A0	PORTAGOMM A D8 CODOLO D10	10	PZ																						
RC1046A	FASCETTA STRINGI TUBO D10-16 H9 INO		KRC1046A	KIT 10PZ FASCETTA STRINGI TUBO D10-16 H9	<table border="1"> <thead> <tr> <th>Codice</th> <th>Descrizione</th> <th>Qtà</th> <th>UM</th> </tr> </thead> <tbody> <tr> <td>RC1046A0</td> <td>FASCETTA STRINGI TUBO D10-16 H9 INO</td> <td>10</td> <td>PZ</td> </tr> </tbody> </table>	Codice	Descrizione	Qtà	UM	RC1046A0	FASCETTA STRINGI TUBO D10-16 H9 INO	10	PZ												
Codice	Descrizione	Qtà	UM																						
RC1046A0	FASCETTA STRINGI TUBO D10-16 H9 INO	10	PZ																						

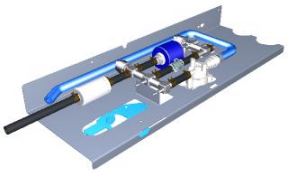
COMPONENTE			RICAMBIO																																						
Codice	Descrizione	Immagine	Codice	Descrizione	Lista componenti																																				
VL1096A	RACCORDO A T -2X PORTAGOMMA D6 - D10 E		KVL1096A	KIT 2PZ RACCORDO T-PORTAG D6-D10-MAGNETI	<table border="1"> <thead> <tr> <th>Codice</th> <th>Descrizione</th> <th>Qtà</th> <th>UM</th> </tr> </thead> <tbody> <tr> <td>RC1018A0</td> <td>FASCETTA ELASTICA D12 ZINCATA</td> <td>2</td> <td>PZ</td> </tr> <tr> <td>VL1086A0</td> <td>MAGNETE NEODIMIO ANTICALCARE</td> <td>2</td> <td>PZ</td> </tr> <tr> <td>VL1096A0</td> <td>RACCORDO A T -2X PORTAGOMM A D6 - D10 E</td> <td>1</td> <td>PZ</td> </tr> </tbody> </table>	Codice	Descrizione	Qtà	UM	RC1018A0	FASCETTA ELASTICA D12 ZINCATA	2	PZ	VL1086A0	MAGNETE NEODIMIO ANTICALCARE	2	PZ	VL1096A0	RACCORDO A T -2X PORTAGOMM A D6 - D10 E	1	PZ																				
Codice	Descrizione	Qtà	UM																																						
RC1018A0	FASCETTA ELASTICA D12 ZINCATA	2	PZ																																						
VL1086A0	MAGNETE NEODIMIO ANTICALCARE	2	PZ																																						
VL1096A0	RACCORDO A T -2X PORTAGOMM A D6 - D10 E	1	PZ																																						
0E1351C	FONDO ESTERNO XEBC		0E1351C0	FONDO ESTERNO XEBC																																					
EL1438A	ELETTRVALVOLA DOPPIO CORPO 5+9 BARBED 6		KEL1438A	KIT ELETTRVALVOLA VAPORE 5+9 BARBED 6	<table border="1"> <thead> <tr> <th>Codice</th> <th>Descrizione</th> <th>Qtà</th> <th>UM</th> </tr> </thead> <tbody> <tr> <td>EL1438A0</td> <td>ELETTRVALV OLA DOPPIO CORPO 5+9 BARBED 6</td> <td>1</td> <td>PZ</td> </tr> </tbody> </table>	Codice	Descrizione	Qtà	UM	EL1438A0	ELETTRVALV OLA DOPPIO CORPO 5+9 BARBED 6	1	PZ																												
Codice	Descrizione	Qtà	UM																																						
EL1438A0	ELETTRVALV OLA DOPPIO CORPO 5+9 BARBED 6	1	PZ																																						
VL1106B	ASM LAVAGGIO ONE EU MONO GIRANTE		KVL1109A	KIT IMPIANTO LAVAGGIO ONE 2 GIRANTI EUR	<table border="1"> <thead> <tr> <th>Codice</th> <th>Descrizione</th> <th>Qtà</th> <th>UM</th> </tr> </thead> <tbody> <tr> <td>0H7324A0</td> <td>LAMIERA SUPPORTO LAVAGGIO ON</td> <td>2</td> <td>PZ</td> </tr> <tr> <td>0H7515A0</td> <td>LAMIERA DOPPIO LAVAGGIO XEVC-2011-E1</td> <td>1</td> <td>PZ</td> </tr> <tr> <td>CH1000A0</td> <td>TAGLIATUBI SNIP</td> <td>1</td> <td>PZ</td> </tr> <tr> <td>EL1115A0</td> <td>RACCORDO A Y Ø8 FEMMINA</td> <td>1</td> <td>PZ</td> </tr> <tr> <td>EL1436A0</td> <td>EV H2O JG D8-PORTAGO MMA D6 CHECK VALVE</td> <td>2</td> <td>PZ</td> </tr> <tr> <td>GN1526A0</td> <td>O-RING D.INT6.9 SP1.8</td> <td>2</td> <td>PZ</td> </tr> <tr> <td>RC1006A0</td> <td>CURVA GUIDA TUBO PET D8</td> <td>4</td> <td>PZ</td> </tr> <tr> <td>RC1019A0</td> <td>FASCETTA ELASTICA D10 ZINCATA</td> <td>30</td> <td>PZ</td> </tr> </tbody> </table>	Codice	Descrizione	Qtà	UM	0H7324A0	LAMIERA SUPPORTO LAVAGGIO ON	2	PZ	0H7515A0	LAMIERA DOPPIO LAVAGGIO XEVC-2011-E1	1	PZ	CH1000A0	TAGLIATUBI SNIP	1	PZ	EL1115A0	RACCORDO A Y Ø8 FEMMINA	1	PZ	EL1436A0	EV H2O JG D8-PORTAGO MMA D6 CHECK VALVE	2	PZ	GN1526A0	O-RING D.INT6.9 SP1.8	2	PZ	RC1006A0	CURVA GUIDA TUBO PET D8	4	PZ	RC1019A0	FASCETTA ELASTICA D10 ZINCATA	30	PZ
Codice	Descrizione	Qtà	UM																																						
0H7324A0	LAMIERA SUPPORTO LAVAGGIO ON	2	PZ																																						
0H7515A0	LAMIERA DOPPIO LAVAGGIO XEVC-2011-E1	1	PZ																																						
CH1000A0	TAGLIATUBI SNIP	1	PZ																																						
EL1115A0	RACCORDO A Y Ø8 FEMMINA	1	PZ																																						
EL1436A0	EV H2O JG D8-PORTAGO MMA D6 CHECK VALVE	2	PZ																																						
GN1526A0	O-RING D.INT6.9 SP1.8	2	PZ																																						
RC1006A0	CURVA GUIDA TUBO PET D8	4	PZ																																						
RC1019A0	FASCETTA ELASTICA D10 ZINCATA	30	PZ																																						

COMPONENTE			RICAMBIO																																																										
Codice	Descrizione	Immagine	Codice	Descrizione	Lista componenti																																																								
VL1106B	ASM LAVAGGIO ONE EU MONO GIRANTE		KVL1109A	KIT IMPIANTO LAVAGGIO ONE 2 GIRANTI EUR	<table border="1"> <thead> <tr> <th>Codice</th> <th>Descrizione</th> <th>Qtà</th> <th>UM</th> </tr> </thead> <tbody> <tr> <td>RC1242A0</td> <td>TERMINALE CHIUSO D10</td> <td>4</td> <td>PZ</td> </tr> <tr> <td>TB1818A0</td> <td>TUBO 8X4.75 PE BLU</td> <td>1.640</td> <td>M</td> </tr> <tr> <td>TB2820A0</td> <td>TUBO EPDM 6X10</td> <td>2.760</td> <td>M</td> </tr> <tr> <td>VI1220A1</td> <td>VITE AUTOFILETTA NTE 4.2X11 TCS+ MARUTE</td> <td>8</td> <td>PZ</td> </tr> <tr> <td>VL1019A0</td> <td>POMPA VIBRAZIONE</td> <td>2</td> <td>PZ</td> </tr> <tr> <td>VL1053B0</td> <td>DISTRIBUTOR E USCITA LAVAGGIO ON</td> <td>2</td> <td>PZ</td> </tr> <tr> <td>VL1054B0</td> <td>DISTRIBUTOR E INGRESSI LAVAGGIO ON</td> <td>2</td> <td>PZ</td> </tr> <tr> <td>VL1080A0</td> <td>FILTRO IN LINEA DETERGENTE</td> <td>2</td> <td>PZ</td> </tr> <tr> <td>VL1081A0</td> <td>VALVOLA NON RITORNO BARBED D6</td> <td>4</td> <td>PZ</td> </tr> <tr> <td>VL1102A0</td> <td>FILTRO IN LINEA CON VNR BARBED 6 MM</td> <td>2</td> <td>PZ</td> </tr> <tr> <td>VL1102A1</td> <td>FILTRO IN LINEA DET. + VNR BARBED 6 MM</td> <td>2</td> <td>PZ</td> </tr> <tr> <td>VL1128A0</td> <td>VALVOLA VNR BARBED D6</td> <td>2</td> <td>PZ</td> </tr> <tr> <td>VM2172A0</td> <td>CLIP BLOCCAGGIO POMPA CON CIRCUITO</td> <td>2</td> <td>PZ</td> </tr> </tbody> </table>	Codice	Descrizione	Qtà	UM	RC1242A0	TERMINALE CHIUSO D10	4	PZ	TB1818A0	TUBO 8X4.75 PE BLU	1.640	M	TB2820A0	TUBO EPDM 6X10	2.760	M	VI1220A1	VITE AUTOFILETTA NTE 4.2X11 TCS+ MARUTE	8	PZ	VL1019A0	POMPA VIBRAZIONE	2	PZ	VL1053B0	DISTRIBUTOR E USCITA LAVAGGIO ON	2	PZ	VL1054B0	DISTRIBUTOR E INGRESSI LAVAGGIO ON	2	PZ	VL1080A0	FILTRO IN LINEA DETERGENTE	2	PZ	VL1081A0	VALVOLA NON RITORNO BARBED D6	4	PZ	VL1102A0	FILTRO IN LINEA CON VNR BARBED 6 MM	2	PZ	VL1102A1	FILTRO IN LINEA DET. + VNR BARBED 6 MM	2	PZ	VL1128A0	VALVOLA VNR BARBED D6	2	PZ	VM2172A0	CLIP BLOCCAGGIO POMPA CON CIRCUITO	2	PZ
			Codice	Descrizione	Qtà	UM																																																							
RC1242A0	TERMINALE CHIUSO D10	4	PZ																																																										
TB1818A0	TUBO 8X4.75 PE BLU	1.640	M																																																										
TB2820A0	TUBO EPDM 6X10	2.760	M																																																										
VI1220A1	VITE AUTOFILETTA NTE 4.2X11 TCS+ MARUTE	8	PZ																																																										
VL1019A0	POMPA VIBRAZIONE	2	PZ																																																										
VL1053B0	DISTRIBUTOR E USCITA LAVAGGIO ON	2	PZ																																																										
VL1054B0	DISTRIBUTOR E INGRESSI LAVAGGIO ON	2	PZ																																																										
VL1080A0	FILTRO IN LINEA DETERGENTE	2	PZ																																																										
VL1081A0	VALVOLA NON RITORNO BARBED D6	4	PZ																																																										
VL1102A0	FILTRO IN LINEA CON VNR BARBED 6 MM	2	PZ																																																										
VL1102A1	FILTRO IN LINEA DET. + VNR BARBED 6 MM	2	PZ																																																										
VL1128A0	VALVOLA VNR BARBED D6	2	PZ																																																										
VM2172A0	CLIP BLOCCAGGIO POMPA CON CIRCUITO	2	PZ																																																										
KVL1106A	KIT IMPIANTO LAVAGGIO ONE 1 GIRANTE EUR	<table border="1"> <thead> <tr> <th>Codice</th> <th>Descrizione</th> <th>Qtà</th> <th>UM</th> </tr> </thead> <tbody> <tr> <td>0H7324A0</td> <td>LAMIERA SUPPORTO LAVAGGIO ON</td> <td>1</td> <td>PZ</td> </tr> <tr> <td>0H7819A0</td> <td>SUPPORTO LAVAGGIO ONE CON ELV STEAM</td> <td>1</td> <td>PZ</td> </tr> <tr> <td>EL1436A0</td> <td>EV H2O JG D8-PORTAGO MMA D6 CHECK VALVE</td> <td>1</td> <td>PZ</td> </tr> <tr> <td>GN1526A0</td> <td>O-RING D.INT6.9 SP1.8</td> <td>1</td> <td>PZ</td> </tr> <tr> <td>RC1006A0</td> <td>CURVA GUIDA TUBO PET D8</td> <td>2</td> <td>PZ</td> </tr> </tbody> </table>	Codice	Descrizione	Qtà	UM	0H7324A0	LAMIERA SUPPORTO LAVAGGIO ON	1	PZ	0H7819A0	SUPPORTO LAVAGGIO ONE CON ELV STEAM	1	PZ	EL1436A0	EV H2O JG D8-PORTAGO MMA D6 CHECK VALVE	1	PZ	GN1526A0	O-RING D.INT6.9 SP1.8	1	PZ	RC1006A0	CURVA GUIDA TUBO PET D8	2	PZ																																			
Codice	Descrizione	Qtà	UM																																																										
0H7324A0	LAMIERA SUPPORTO LAVAGGIO ON	1	PZ																																																										
0H7819A0	SUPPORTO LAVAGGIO ONE CON ELV STEAM	1	PZ																																																										
EL1436A0	EV H2O JG D8-PORTAGO MMA D6 CHECK VALVE	1	PZ																																																										
GN1526A0	O-RING D.INT6.9 SP1.8	1	PZ																																																										
RC1006A0	CURVA GUIDA TUBO PET D8	2	PZ																																																										

COMPONENTE			RICAMBIO																																																																		
<i>Codice</i>	<i>Descrizione</i>	<i>Immagine</i>	<i>Codice</i>	<i>Descrizione</i>	<i>Lista componenti</i>																																																																
VL1106B	ASM LAVAGGIO ONE EU MONO GIRANTE		KVL1106A	KIT IMPIANTO LAVAGGIO ONE 1 GIRANTE EUR	<table border="1"> <thead> <tr> <th><i>Codice</i></th> <th><i>Descrizione</i></th> <th><i>Qtà</i></th> <th><i>UM</i></th> </tr> </thead> <tbody> <tr> <td>RC1019A0</td> <td>FASCETTA ELASTICA D10 ZINCATA</td> <td>15</td> <td>PZ</td> </tr> <tr> <td>RC1242A0</td> <td>TERMINALE CHIUSO D10</td> <td>2</td> <td>PZ</td> </tr> <tr> <td>RC1408A0</td> <td>FASCETTA BIFILARE A MOLLA D10.8 TUBO ZN</td> <td>2</td> <td>PZ</td> </tr> <tr> <td>TB1818A0</td> <td>TUBO 8X4.75 PE BLU</td> <td>0.320</td> <td>M</td> </tr> <tr> <td>TB2820A0</td> <td>TUBO EPDM 6X10</td> <td>1.380</td> <td>M</td> </tr> <tr> <td>VI1220A1</td> <td>VITE AUTOFILETTA NTE 4.2X11 TCS+ MARUTE</td> <td>1</td> <td>PZ</td> </tr> <tr> <td>VL1019A0</td> <td>POMPA VIBRAZIONE</td> <td>1</td> <td>PZ</td> </tr> <tr> <td>VL1053B0</td> <td>DISTRIBUTOR E USCITA LAVAGGIO ON</td> <td>1</td> <td>PZ</td> </tr> <tr> <td>VL1054B0</td> <td>DISTRIBUTOR E INGRESSI LAVAGGIO ON</td> <td>1</td> <td>PZ</td> </tr> <tr> <td>VL1080A0</td> <td>FILTRO IN LINEA DETERGENTE</td> <td>1</td> <td>PZ</td> </tr> <tr> <td>VL1081A0</td> <td>VALVOLA NON RITORNO BARBED D6</td> <td>1</td> <td>PZ</td> </tr> <tr> <td>VL1102A0</td> <td>FILTRO IN LINEA CON VNR BARBED 6 MM</td> <td>1</td> <td>PZ</td> </tr> <tr> <td>VL1102A1</td> <td>FILTRO IN LINEA DET. + VNR BARBED 6 MM</td> <td>1</td> <td>PZ</td> </tr> <tr> <td>VL1128A0</td> <td>VALVOLA VNR BARBED D6</td> <td>1</td> <td>PZ</td> </tr> <tr> <td>VM2172A0</td> <td>CLIP BLOCCAGGIO POMPA CON CIRCUITO</td> <td>1</td> <td>PZ</td> </tr> </tbody> </table>	<i>Codice</i>	<i>Descrizione</i>	<i>Qtà</i>	<i>UM</i>	RC1019A0	FASCETTA ELASTICA D10 ZINCATA	15	PZ	RC1242A0	TERMINALE CHIUSO D10	2	PZ	RC1408A0	FASCETTA BIFILARE A MOLLA D10.8 TUBO ZN	2	PZ	TB1818A0	TUBO 8X4.75 PE BLU	0.320	M	TB2820A0	TUBO EPDM 6X10	1.380	M	VI1220A1	VITE AUTOFILETTA NTE 4.2X11 TCS+ MARUTE	1	PZ	VL1019A0	POMPA VIBRAZIONE	1	PZ	VL1053B0	DISTRIBUTOR E USCITA LAVAGGIO ON	1	PZ	VL1054B0	DISTRIBUTOR E INGRESSI LAVAGGIO ON	1	PZ	VL1080A0	FILTRO IN LINEA DETERGENTE	1	PZ	VL1081A0	VALVOLA NON RITORNO BARBED D6	1	PZ	VL1102A0	FILTRO IN LINEA CON VNR BARBED 6 MM	1	PZ	VL1102A1	FILTRO IN LINEA DET. + VNR BARBED 6 MM	1	PZ	VL1128A0	VALVOLA VNR BARBED D6	1	PZ	VM2172A0	CLIP BLOCCAGGIO POMPA CON CIRCUITO	1	PZ
<i>Codice</i>	<i>Descrizione</i>	<i>Qtà</i>	<i>UM</i>																																																																		
RC1019A0	FASCETTA ELASTICA D10 ZINCATA	15	PZ																																																																		
RC1242A0	TERMINALE CHIUSO D10	2	PZ																																																																		
RC1408A0	FASCETTA BIFILARE A MOLLA D10.8 TUBO ZN	2	PZ																																																																		
TB1818A0	TUBO 8X4.75 PE BLU	0.320	M																																																																		
TB2820A0	TUBO EPDM 6X10	1.380	M																																																																		
VI1220A1	VITE AUTOFILETTA NTE 4.2X11 TCS+ MARUTE	1	PZ																																																																		
VL1019A0	POMPA VIBRAZIONE	1	PZ																																																																		
VL1053B0	DISTRIBUTOR E USCITA LAVAGGIO ON	1	PZ																																																																		
VL1054B0	DISTRIBUTOR E INGRESSI LAVAGGIO ON	1	PZ																																																																		
VL1080A0	FILTRO IN LINEA DETERGENTE	1	PZ																																																																		
VL1081A0	VALVOLA NON RITORNO BARBED D6	1	PZ																																																																		
VL1102A0	FILTRO IN LINEA CON VNR BARBED 6 MM	1	PZ																																																																		
VL1102A1	FILTRO IN LINEA DET. + VNR BARBED 6 MM	1	PZ																																																																		
VL1128A0	VALVOLA VNR BARBED D6	1	PZ																																																																		
VM2172A0	CLIP BLOCCAGGIO POMPA CON CIRCUITO	1	PZ																																																																		

COMPONENTE			RICAMBIO																						
Codice	Descrizione	Immagine	Codice	Descrizione	Lista componenti																				
RC1019A	FASCETTA ELASTICA D10 ZINCATA		KRC1019A	KIT 15 PZ. FASCETTA ELASTICA D10 ZINCATA	<table border="1"> <thead> <tr> <th>Codice</th> <th>Descrizione</th> <th>Qtà</th> <th>UM</th> </tr> </thead> <tbody> <tr> <td>RC1019A0</td> <td>FASCETTA ELASTICA D10 ZINCATA</td> <td>15</td> <td>PZ</td> </tr> </tbody> </table>	Codice	Descrizione	Qtà	UM	RC1019A0	FASCETTA ELASTICA D10 ZINCATA	15	PZ												
Codice	Descrizione	Qtà	UM																						
RC1019A0	FASCETTA ELASTICA D10 ZINCATA	15	PZ																						
TB3007A	TB2820A-ROCCETTO DETERGENTE ONE PER GIR		KTB3007A	KIT ROCCETTO DETERGENTE ONE	<table border="1"> <thead> <tr> <th>Codice</th> <th>Descrizione</th> <th>Qtà</th> <th>UM</th> </tr> </thead> <tbody> <tr> <td>TB2820A0</td> <td>TUBO EPDM 6X10</td> <td>0.550</td> <td>M</td> </tr> </tbody> </table>	Codice	Descrizione	Qtà	UM	TB2820A0	TUBO EPDM 6X10	0.550	M												
Codice	Descrizione	Qtà	UM																						
TB2820A0	TUBO EPDM 6X10	0.550	M																						
TB3225B	TB2820A-COLLEGAMENTO TANICA-GRUPPO LAVAG		TB3225B0	TB2820A-COLLEGAMENTO TANICA-GRUPPO LAVAG																					
VL1102A	FILTRO IN LINEA CON VNR BARBED 6 MM		KVL1102A	KIT FILTRO IN LINEA DETERGENTE CON VNR	<table border="1"> <thead> <tr> <th>Codice</th> <th>Descrizione</th> <th>Qtà</th> <th>UM</th> </tr> </thead> <tbody> <tr> <td>RC1019A0</td> <td>FASCETTA ELASTICA D10 ZINCATA</td> <td>3</td> <td>PZ</td> </tr> <tr> <td>TB2820A0</td> <td>TUBO EPDM 6X10</td> <td>0.110</td> <td>M</td> </tr> <tr> <td>VL1102A0</td> <td>FILTRO IN LINEA CON VNR BARBED 6 MM</td> <td>1</td> <td>PZ</td> </tr> <tr> <td>VL1102A1</td> <td>FILTRO IN LINEA DET. + VNR BARBED 6 MM</td> <td>1</td> <td>PZ</td> </tr> </tbody> </table>	Codice	Descrizione	Qtà	UM	RC1019A0	FASCETTA ELASTICA D10 ZINCATA	3	PZ	TB2820A0	TUBO EPDM 6X10	0.110	M	VL1102A0	FILTRO IN LINEA CON VNR BARBED 6 MM	1	PZ	VL1102A1	FILTRO IN LINEA DET. + VNR BARBED 6 MM	1	PZ
Codice	Descrizione	Qtà	UM																						
RC1019A0	FASCETTA ELASTICA D10 ZINCATA	3	PZ																						
TB2820A0	TUBO EPDM 6X10	0.110	M																						
VL1102A0	FILTRO IN LINEA CON VNR BARBED 6 MM	1	PZ																						
VL1102A1	FILTRO IN LINEA DET. + VNR BARBED 6 MM	1	PZ																						
VL1047A	PORTAGOMMA D6 CODOLO D8		KVL1047A	KIT 10 PZ PORTAGOMMA D6 CODOLO D8	<table border="1"> <thead> <tr> <th>Codice</th> <th>Descrizione</th> <th>Qtà</th> <th>UM</th> </tr> </thead> <tbody> <tr> <td>VL1047A1</td> <td>PORTAGOMMA D6 CODOLO D8</td> <td>10</td> <td>PZ</td> </tr> </tbody> </table>	Codice	Descrizione	Qtà	UM	VL1047A1	PORTAGOMMA D6 CODOLO D8	10	PZ												
Codice	Descrizione	Qtà	UM																						
VL1047A1	PORTAGOMMA D6 CODOLO D8	10	PZ																						
			KVL0016A	KIT 260PZ ADATTAMENTO BRITA IMP.LAVAG M	<table border="1"> <thead> <tr> <th>Codice</th> <th>Descrizione</th> <th>Qtà</th> <th>UM</th> </tr> </thead> <tbody> <tr> <td>EL1185A0</td> <td>RACCORDO A GOMITO J.GUEST Ø8F - Ø8F</td> <td>1</td> <td>PZ</td> </tr> </tbody> </table>	Codice	Descrizione	Qtà	UM	EL1185A0	RACCORDO A GOMITO J.GUEST Ø8F - Ø8F	1	PZ												
Codice	Descrizione	Qtà	UM																						
EL1185A0	RACCORDO A GOMITO J.GUEST Ø8F - Ø8F	1	PZ																						

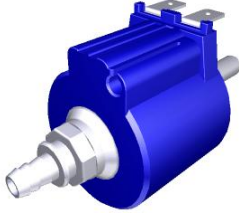
COMPONENTE			RICAMBIO																																																										
Codice	Descrizione	Immagine	Codice	Descrizione	Lista componenti																																																								
VL1047A	PORTAGOMMA D6 CODOLO D8		KVL0016A	KIT 260PZ ADATTAMENTO BRITA IMP.LAVAG M	<table border="1"> <thead> <tr> <th>Codice</th> <th>Descrizione</th> <th>Qtà</th> <th>UM</th> </tr> </thead> <tbody> <tr> <td>RC1018A0</td> <td>FASCETTA ELASTICA D12 ZINCATA</td> <td>2</td> <td>PZ</td> </tr> <tr> <td>VL1047A1</td> <td>PORTAGOMM A D6 CODOLO D8</td> <td>2</td> <td>PZ</td> </tr> </tbody> </table>	Codice	Descrizione	Qtà	UM	RC1018A0	FASCETTA ELASTICA D12 ZINCATA	2	PZ	VL1047A1	PORTAGOMM A D6 CODOLO D8	2	PZ																																												
Codice	Descrizione	Qtà	UM																																																										
RC1018A0	FASCETTA ELASTICA D12 ZINCATA	2	PZ																																																										
VL1047A1	PORTAGOMM A D6 CODOLO D8	2	PZ																																																										
VL1019A	POMPA VIBRAZIONE		KVL1120A	KIT IMPIANTO LAVAGGIO PLUS COMPACT USA	<table border="1"> <thead> <tr> <th>Codice</th> <th>Descrizione</th> <th>Qtà</th> <th>UM</th> </tr> </thead> <tbody> <tr> <td>0H7553D0</td> <td>LAMIERA CIRCUITO LAVAGGIO XECC PLUS</td> <td>1</td> <td>PZ</td> </tr> <tr> <td>EL1422A1</td> <td>ELETTROVALV 1 VIA RID.VERDE JG D8-D10 UL</td> <td>1</td> <td>PZ</td> </tr> <tr> <td>EL1426A0</td> <td>ELETTROVALV OLA UL H2O JG D8-PORTAGO MMA D</td> <td>1</td> <td>PZ</td> </tr> <tr> <td>EL1437A0</td> <td>EV H2O JG D8-PORTAGO MMA D6 CH. VALVE UL</td> <td>1</td> <td>PZ</td> </tr> <tr> <td>GN1312A0</td> <td>PASSACAVO GOMMA DE=26 DI=15 SP=10</td> <td>1</td> <td>PZ</td> </tr> <tr> <td>GN1526A0</td> <td>O-RING D.INT6.9 SP1.8</td> <td>1</td> <td>PZ</td> </tr> <tr> <td>RC1019A0</td> <td>FASCETTA ELASTICA D10 ZINCATA</td> <td>8</td> <td>PZ</td> </tr> <tr> <td>RC1242A0</td> <td>TERMINALE CHIUSO D10</td> <td>2</td> <td>PZ</td> </tr> <tr> <td>RC1356A0</td> <td>RACCORDO DRITTO FIL. FEMM 8X1/4 BSP</td> <td>1</td> <td>PZ</td> </tr> <tr> <td>RC1408A0</td> <td>FASCETTA BIFILARE A MOLLA D10.8 TUBO ZN</td> <td>2</td> <td>PZ</td> </tr> <tr> <td>TB2820A0</td> <td>TUBO EPDM 6X10</td> <td>1.200</td> <td>M</td> </tr> <tr> <td>VI1220A1</td> <td>VITE AUTOFILETTA NTE 4.2X11 TCS+ MARUTE</td> <td>9</td> <td>PZ</td> </tr> <tr> <td>VL1019A0</td> <td>POMPA VIBRAZIONE</td> <td>1</td> <td>PZ</td> </tr> </tbody> </table>	Codice	Descrizione	Qtà	UM	0H7553D0	LAMIERA CIRCUITO LAVAGGIO XECC PLUS	1	PZ	EL1422A1	ELETTROVALV 1 VIA RID.VERDE JG D8-D10 UL	1	PZ	EL1426A0	ELETTROVALV OLA UL H2O JG D8-PORTAGO MMA D	1	PZ	EL1437A0	EV H2O JG D8-PORTAGO MMA D6 CH. VALVE UL	1	PZ	GN1312A0	PASSACAVO GOMMA DE=26 DI=15 SP=10	1	PZ	GN1526A0	O-RING D.INT6.9 SP1.8	1	PZ	RC1019A0	FASCETTA ELASTICA D10 ZINCATA	8	PZ	RC1242A0	TERMINALE CHIUSO D10	2	PZ	RC1356A0	RACCORDO DRITTO FIL. FEMM 8X1/4 BSP	1	PZ	RC1408A0	FASCETTA BIFILARE A MOLLA D10.8 TUBO ZN	2	PZ	TB2820A0	TUBO EPDM 6X10	1.200	M	VI1220A1	VITE AUTOFILETTA NTE 4.2X11 TCS+ MARUTE	9	PZ	VL1019A0	POMPA VIBRAZIONE	1	PZ
Codice	Descrizione	Qtà	UM																																																										
0H7553D0	LAMIERA CIRCUITO LAVAGGIO XECC PLUS	1	PZ																																																										
EL1422A1	ELETTROVALV 1 VIA RID.VERDE JG D8-D10 UL	1	PZ																																																										
EL1426A0	ELETTROVALV OLA UL H2O JG D8-PORTAGO MMA D	1	PZ																																																										
EL1437A0	EV H2O JG D8-PORTAGO MMA D6 CH. VALVE UL	1	PZ																																																										
GN1312A0	PASSACAVO GOMMA DE=26 DI=15 SP=10	1	PZ																																																										
GN1526A0	O-RING D.INT6.9 SP1.8	1	PZ																																																										
RC1019A0	FASCETTA ELASTICA D10 ZINCATA	8	PZ																																																										
RC1242A0	TERMINALE CHIUSO D10	2	PZ																																																										
RC1356A0	RACCORDO DRITTO FIL. FEMM 8X1/4 BSP	1	PZ																																																										
RC1408A0	FASCETTA BIFILARE A MOLLA D10.8 TUBO ZN	2	PZ																																																										
TB2820A0	TUBO EPDM 6X10	1.200	M																																																										
VI1220A1	VITE AUTOFILETTA NTE 4.2X11 TCS+ MARUTE	9	PZ																																																										
VL1019A0	POMPA VIBRAZIONE	1	PZ																																																										

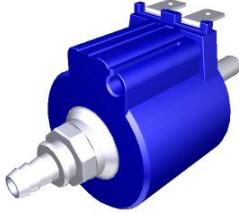
COMPONENTE			RICAMBIO																																						
Codice	Descrizione	Immagine	Codice	Descrizione	Lista componenti																																				
VL1019A	POMPA VIBRAZIONE		KVL1120A	KIT IMPIANTO LAVAGGIO PLUS COMPACT USA	<table border="1"> <thead> <tr> <th>Codice</th> <th>Descrizione</th> <th>Qtà</th> <th>UM</th> </tr> </thead> <tbody> <tr> <td>VL1054B0</td> <td>DISTRIBUTOR E INGRESSI LAVAGGIO ON</td> <td>1</td> <td>PZ</td> </tr> <tr> <td>VL1064A0</td> <td>DISTRIBUTOR E USCITE CIRCUITO LAVAGGIO PL</td> <td>1</td> <td>PZ</td> </tr> <tr> <td>VL1065A1</td> <td>PRESSOSTAT O.N.O. 1/4 M CI</td> <td>1</td> <td>PZ</td> </tr> <tr> <td>VL1081A0</td> <td>VALVOLA NON RITORNO BARBED D6</td> <td>1</td> <td>PZ</td> </tr> <tr> <td>VL1102A0</td> <td>FILTRO IN LINEA CON VNR BARBED 6 MM</td> <td>1</td> <td>PZ</td> </tr> <tr> <td>VL1102A1</td> <td>FILTRO IN LINEA DET. + VNR BARBED 6 MM</td> <td>1</td> <td>PZ</td> </tr> <tr> <td>VL1128A0</td> <td>VALVOLA VNR BARBED D6</td> <td>1</td> <td>PZ</td> </tr> <tr> <td>VM2172A0</td> <td>CLIP BLOCCAGGIO POMPA CON CIRCUITO</td> <td>1</td> <td>PZ</td> </tr> </tbody> </table>	Codice	Descrizione	Qtà	UM	VL1054B0	DISTRIBUTOR E INGRESSI LAVAGGIO ON	1	PZ	VL1064A0	DISTRIBUTOR E USCITE CIRCUITO LAVAGGIO PL	1	PZ	VL1065A1	PRESSOSTAT O.N.O. 1/4 M CI	1	PZ	VL1081A0	VALVOLA NON RITORNO BARBED D6	1	PZ	VL1102A0	FILTRO IN LINEA CON VNR BARBED 6 MM	1	PZ	VL1102A1	FILTRO IN LINEA DET. + VNR BARBED 6 MM	1	PZ	VL1128A0	VALVOLA VNR BARBED D6	1	PZ	VM2172A0	CLIP BLOCCAGGIO POMPA CON CIRCUITO	1	PZ
Codice	Descrizione	Qtà	UM																																						
VL1054B0	DISTRIBUTOR E INGRESSI LAVAGGIO ON	1	PZ																																						
VL1064A0	DISTRIBUTOR E USCITE CIRCUITO LAVAGGIO PL	1	PZ																																						
VL1065A1	PRESSOSTAT O.N.O. 1/4 M CI	1	PZ																																						
VL1081A0	VALVOLA NON RITORNO BARBED D6	1	PZ																																						
VL1102A0	FILTRO IN LINEA CON VNR BARBED 6 MM	1	PZ																																						
VL1102A1	FILTRO IN LINEA DET. + VNR BARBED 6 MM	1	PZ																																						
VL1128A0	VALVOLA VNR BARBED D6	1	PZ																																						
VM2172A0	CLIP BLOCCAGGIO POMPA CON CIRCUITO	1	PZ																																						
			KVL1119A	KIT IMPIANTO LAVAGGIO PLUS COMPACT EUR	<table border="1"> <thead> <tr> <th>Codice</th> <th>Descrizione</th> <th>Qtà</th> <th>UM</th> </tr> </thead> <tbody> <tr> <td>0H7553C0</td> <td>LAMIERA CIRCUITO LAVAGGIO XECC PLUS</td> <td>1</td> <td>PZ</td> </tr> <tr> <td>0H7553D0</td> <td>LAMIERA CIRCUITO LAVAGGIO XECC PLUS</td> <td>1</td> <td>PZ</td> </tr> <tr> <td>EL1252A1</td> <td>ELETTROVALV OLA 1 VIA RID.VERDE JG D8-D10</td> <td>1</td> <td>PZ</td> </tr> <tr> <td>EL1424A0</td> <td>ELETTROVALV OLA H2O JG D8-PORTAGO MMA D6</td> <td>1</td> <td>PZ</td> </tr> <tr> <td>EL1436A0</td> <td>EV H2O JG D8-PORTAGO MMA D6 CHECK VALVE</td> <td>1</td> <td>PZ</td> </tr> <tr> <td>GN1312A0</td> <td>PASSACAVO GOMMA DE=26 DI=15 SP=10</td> <td>1</td> <td>PZ</td> </tr> <tr> <td>GN1526A0</td> <td>O-RING D.INT6.9 SP1.8</td> <td>1</td> <td>PZ</td> </tr> </tbody> </table>	Codice	Descrizione	Qtà	UM	0H7553C0	LAMIERA CIRCUITO LAVAGGIO XECC PLUS	1	PZ	0H7553D0	LAMIERA CIRCUITO LAVAGGIO XECC PLUS	1	PZ	EL1252A1	ELETTROVALV OLA 1 VIA RID.VERDE JG D8-D10	1	PZ	EL1424A0	ELETTROVALV OLA H2O JG D8-PORTAGO MMA D6	1	PZ	EL1436A0	EV H2O JG D8-PORTAGO MMA D6 CHECK VALVE	1	PZ	GN1312A0	PASSACAVO GOMMA DE=26 DI=15 SP=10	1	PZ	GN1526A0	O-RING D.INT6.9 SP1.8	1	PZ				
Codice	Descrizione	Qtà	UM																																						
0H7553C0	LAMIERA CIRCUITO LAVAGGIO XECC PLUS	1	PZ																																						
0H7553D0	LAMIERA CIRCUITO LAVAGGIO XECC PLUS	1	PZ																																						
EL1252A1	ELETTROVALV OLA 1 VIA RID.VERDE JG D8-D10	1	PZ																																						
EL1424A0	ELETTROVALV OLA H2O JG D8-PORTAGO MMA D6	1	PZ																																						
EL1436A0	EV H2O JG D8-PORTAGO MMA D6 CHECK VALVE	1	PZ																																						
GN1312A0	PASSACAVO GOMMA DE=26 DI=15 SP=10	1	PZ																																						
GN1526A0	O-RING D.INT6.9 SP1.8	1	PZ																																						

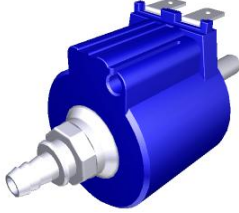
COMPONENTE			RICAMBIO																																																																																		
Codice	Descrizione	Immagine	Codice	Descrizione	Lista componenti																																																																																
VL1019A	POMPA VIBRAZIONE		KVL1119A	KIT IMPIANTO LAVAGGIO PLUS COMPACT EUR	<table border="1"> <thead> <tr> <th>Codice</th> <th>Descrizione</th> <th>Qtà</th> <th>UM</th> </tr> </thead> <tbody> <tr> <td>RC1006A0</td> <td>CURVA GUIDA TUBO PET D8</td> <td>2</td> <td>PZ</td> </tr> <tr> <td>RC1019A0</td> <td>FASCETTA ELASTICA D10 ZINCATA</td> <td>9</td> <td>PZ</td> </tr> <tr> <td>RC1242A0</td> <td>TERMINALE CHIUSO D10</td> <td>2</td> <td>PZ</td> </tr> <tr> <td>RC1356A0</td> <td>RACCORDO DRITTO FIL. FEMM 8X1/4 BSP</td> <td>1</td> <td>PZ</td> </tr> <tr> <td>RC1408A0</td> <td>FASCETTA BIFILARE A MOLLA D10.8 TUBO ZN</td> <td>2</td> <td>PZ</td> </tr> <tr> <td>TB1818A0</td> <td>TUBO 8X4.75 PE BLU</td> <td>0.680</td> <td>M</td> </tr> <tr> <td>TB2820A0</td> <td>TUBO EPDM 6X10</td> <td>1.700</td> <td>M</td> </tr> <tr> <td>VI1220A1</td> <td>VITE AUTOFILETTA NTE 4.2X11 TCS+ MARUTE</td> <td>10</td> <td>PZ</td> </tr> <tr> <td>VL1019A0</td> <td>POMPA VIBRAZIONE</td> <td>1</td> <td>PZ</td> </tr> <tr> <td>VL1054B0</td> <td>DISTRIBUTOR E INGRESSI LAVAGGIO ON</td> <td>1</td> <td>PZ</td> </tr> <tr> <td>VL1064A0</td> <td>DISTRIBUTOR E USCITE CIRCUITO LAVAGGIO PL</td> <td>1</td> <td>PZ</td> </tr> <tr> <td>VL1065A1</td> <td>PRESSOSTAT O.N.O. 1/4 M CI</td> <td>1</td> <td>PZ</td> </tr> <tr> <td>VL1081A0</td> <td>VALVOLA NON RITORNO BARBED D6</td> <td>1</td> <td>PZ</td> </tr> <tr> <td>VL1083A0</td> <td>RACCORDO D10 - PORTAGOMM A BARBED D6</td> <td>1</td> <td>PZ</td> </tr> <tr> <td>VL1102A0</td> <td>FILTRO IN LINEA CON VNR BARBED 6 MM</td> <td>1</td> <td>PZ</td> </tr> <tr> <td>VL1102A1</td> <td>FILTRO IN LINEA DET. + VNR BARBED 6 MM</td> <td>1</td> <td>PZ</td> </tr> <tr> <td>VL1128A0</td> <td>VALVOLA VNR BARBED D6</td> <td>1</td> <td>PZ</td> </tr> <tr> <td>VM1610A0</td> <td>CLIP TWIST LOCK DIAM. 7,6-10,2 MM</td> <td>3</td> <td>PZ</td> </tr> <tr> <td>VM2172A0</td> <td>CLIP BLOCCAGGIO POMPA CON CIRCUITO</td> <td>1</td> <td>PZ</td> </tr> </tbody> </table>	Codice	Descrizione	Qtà	UM	RC1006A0	CURVA GUIDA TUBO PET D8	2	PZ	RC1019A0	FASCETTA ELASTICA D10 ZINCATA	9	PZ	RC1242A0	TERMINALE CHIUSO D10	2	PZ	RC1356A0	RACCORDO DRITTO FIL. FEMM 8X1/4 BSP	1	PZ	RC1408A0	FASCETTA BIFILARE A MOLLA D10.8 TUBO ZN	2	PZ	TB1818A0	TUBO 8X4.75 PE BLU	0.680	M	TB2820A0	TUBO EPDM 6X10	1.700	M	VI1220A1	VITE AUTOFILETTA NTE 4.2X11 TCS+ MARUTE	10	PZ	VL1019A0	POMPA VIBRAZIONE	1	PZ	VL1054B0	DISTRIBUTOR E INGRESSI LAVAGGIO ON	1	PZ	VL1064A0	DISTRIBUTOR E USCITE CIRCUITO LAVAGGIO PL	1	PZ	VL1065A1	PRESSOSTAT O.N.O. 1/4 M CI	1	PZ	VL1081A0	VALVOLA NON RITORNO BARBED D6	1	PZ	VL1083A0	RACCORDO D10 - PORTAGOMM A BARBED D6	1	PZ	VL1102A0	FILTRO IN LINEA CON VNR BARBED 6 MM	1	PZ	VL1102A1	FILTRO IN LINEA DET. + VNR BARBED 6 MM	1	PZ	VL1128A0	VALVOLA VNR BARBED D6	1	PZ	VM1610A0	CLIP TWIST LOCK DIAM. 7,6-10,2 MM	3	PZ	VM2172A0	CLIP BLOCCAGGIO POMPA CON CIRCUITO	1	PZ
Codice	Descrizione	Qtà	UM																																																																																		
RC1006A0	CURVA GUIDA TUBO PET D8	2	PZ																																																																																		
RC1019A0	FASCETTA ELASTICA D10 ZINCATA	9	PZ																																																																																		
RC1242A0	TERMINALE CHIUSO D10	2	PZ																																																																																		
RC1356A0	RACCORDO DRITTO FIL. FEMM 8X1/4 BSP	1	PZ																																																																																		
RC1408A0	FASCETTA BIFILARE A MOLLA D10.8 TUBO ZN	2	PZ																																																																																		
TB1818A0	TUBO 8X4.75 PE BLU	0.680	M																																																																																		
TB2820A0	TUBO EPDM 6X10	1.700	M																																																																																		
VI1220A1	VITE AUTOFILETTA NTE 4.2X11 TCS+ MARUTE	10	PZ																																																																																		
VL1019A0	POMPA VIBRAZIONE	1	PZ																																																																																		
VL1054B0	DISTRIBUTOR E INGRESSI LAVAGGIO ON	1	PZ																																																																																		
VL1064A0	DISTRIBUTOR E USCITE CIRCUITO LAVAGGIO PL	1	PZ																																																																																		
VL1065A1	PRESSOSTAT O.N.O. 1/4 M CI	1	PZ																																																																																		
VL1081A0	VALVOLA NON RITORNO BARBED D6	1	PZ																																																																																		
VL1083A0	RACCORDO D10 - PORTAGOMM A BARBED D6	1	PZ																																																																																		
VL1102A0	FILTRO IN LINEA CON VNR BARBED 6 MM	1	PZ																																																																																		
VL1102A1	FILTRO IN LINEA DET. + VNR BARBED 6 MM	1	PZ																																																																																		
VL1128A0	VALVOLA VNR BARBED D6	1	PZ																																																																																		
VM1610A0	CLIP TWIST LOCK DIAM. 7,6-10,2 MM	3	PZ																																																																																		
VM2172A0	CLIP BLOCCAGGIO POMPA CON CIRCUITO	1	PZ																																																																																		

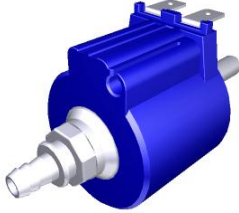
COMPONENTE			RICAMBIO																																																																						
Codice	Descrizione	Immagine	Codice	Descrizione	Lista componenti																																																																				
VL1019A	POMPA VIBRAZIONE		KVL1118A	KIT IMPIANTO LAVAGGIO ONE COMPACT EUR	<table border="1"> <thead> <tr> <th>Codice</th> <th>Descrizione</th> <th>Qtà</th> <th>UM</th> </tr> </thead> <tbody> <tr> <td>0H7173C0</td> <td>LAMIERA CIRCUITO LAVAGGIO XECC ONE</td> <td>1</td> <td>PZ</td> </tr> <tr> <td>EL1436A0</td> <td>EV H2O JG D8-PORTAGO MMA D6 CHECK VALVE</td> <td>1</td> <td>PZ</td> </tr> <tr> <td>GN1526A0</td> <td>O-RING D.INT6.9 SP1.8</td> <td>1</td> <td>PZ</td> </tr> <tr> <td>RC1019A0</td> <td>FASCETTA ELASTICA D10 ZINCATA</td> <td>10</td> <td>PZ</td> </tr> <tr> <td>RC1242A0</td> <td>TERMINALE CHIUSO D10</td> <td>2</td> <td>PZ</td> </tr> <tr> <td>RC1408A0</td> <td>FASCETTA BIFILARE A MOLLA D10.8 TUBO ZN</td> <td>2</td> <td>PZ</td> </tr> <tr> <td>TB2820A0</td> <td>TUBO EPDM 6X10</td> <td>1.200</td> <td>M</td> </tr> <tr> <td>VI1220A1</td> <td>VITE AUTOFILETTA NTE 4.2X11 TCS+ MARUTE</td> <td>6</td> <td>PZ</td> </tr> <tr> <td>VL1019A0</td> <td>POMPA VIBRAZIONE</td> <td>1</td> <td>PZ</td> </tr> <tr> <td>VL1053B0</td> <td>DISTRIBUTOR E USCITA LAVAGGIO ON</td> <td>1</td> <td>PZ</td> </tr> <tr> <td>VL1054B0</td> <td>DISTRIBUTOR E INGRESSI LAVAGGIO ON</td> <td>1</td> <td>PZ</td> </tr> <tr> <td>VL1081A0</td> <td>VALVOLA NON RITORNO BARBED D6</td> <td>1</td> <td>PZ</td> </tr> <tr> <td>VL1102A0</td> <td>FILTRO IN LINEA CON VNR BARBED 6 MM</td> <td>1</td> <td>PZ</td> </tr> <tr> <td>VL1102A1</td> <td>FILTRO IN LINEA DET. + VNR BARBED 6 MM</td> <td>1</td> <td>PZ</td> </tr> <tr> <td>VL1128A0</td> <td>VALVOLA VNR BARBED D6</td> <td>1</td> <td>PZ</td> </tr> <tr> <td>VM2172A0</td> <td>CLIP BLOCCAGGIO POMPA CON CIRCUITO</td> <td>1</td> <td>PZ</td> </tr> </tbody> </table>	Codice	Descrizione	Qtà	UM	0H7173C0	LAMIERA CIRCUITO LAVAGGIO XECC ONE	1	PZ	EL1436A0	EV H2O JG D8-PORTAGO MMA D6 CHECK VALVE	1	PZ	GN1526A0	O-RING D.INT6.9 SP1.8	1	PZ	RC1019A0	FASCETTA ELASTICA D10 ZINCATA	10	PZ	RC1242A0	TERMINALE CHIUSO D10	2	PZ	RC1408A0	FASCETTA BIFILARE A MOLLA D10.8 TUBO ZN	2	PZ	TB2820A0	TUBO EPDM 6X10	1.200	M	VI1220A1	VITE AUTOFILETTA NTE 4.2X11 TCS+ MARUTE	6	PZ	VL1019A0	POMPA VIBRAZIONE	1	PZ	VL1053B0	DISTRIBUTOR E USCITA LAVAGGIO ON	1	PZ	VL1054B0	DISTRIBUTOR E INGRESSI LAVAGGIO ON	1	PZ	VL1081A0	VALVOLA NON RITORNO BARBED D6	1	PZ	VL1102A0	FILTRO IN LINEA CON VNR BARBED 6 MM	1	PZ	VL1102A1	FILTRO IN LINEA DET. + VNR BARBED 6 MM	1	PZ	VL1128A0	VALVOLA VNR BARBED D6	1	PZ	VM2172A0	CLIP BLOCCAGGIO POMPA CON CIRCUITO	1	PZ
Codice	Descrizione	Qtà	UM																																																																						
0H7173C0	LAMIERA CIRCUITO LAVAGGIO XECC ONE	1	PZ																																																																						
EL1436A0	EV H2O JG D8-PORTAGO MMA D6 CHECK VALVE	1	PZ																																																																						
GN1526A0	O-RING D.INT6.9 SP1.8	1	PZ																																																																						
RC1019A0	FASCETTA ELASTICA D10 ZINCATA	10	PZ																																																																						
RC1242A0	TERMINALE CHIUSO D10	2	PZ																																																																						
RC1408A0	FASCETTA BIFILARE A MOLLA D10.8 TUBO ZN	2	PZ																																																																						
TB2820A0	TUBO EPDM 6X10	1.200	M																																																																						
VI1220A1	VITE AUTOFILETTA NTE 4.2X11 TCS+ MARUTE	6	PZ																																																																						
VL1019A0	POMPA VIBRAZIONE	1	PZ																																																																						
VL1053B0	DISTRIBUTOR E USCITA LAVAGGIO ON	1	PZ																																																																						
VL1054B0	DISTRIBUTOR E INGRESSI LAVAGGIO ON	1	PZ																																																																						
VL1081A0	VALVOLA NON RITORNO BARBED D6	1	PZ																																																																						
VL1102A0	FILTRO IN LINEA CON VNR BARBED 6 MM	1	PZ																																																																						
VL1102A1	FILTRO IN LINEA DET. + VNR BARBED 6 MM	1	PZ																																																																						
VL1128A0	VALVOLA VNR BARBED D6	1	PZ																																																																						
VM2172A0	CLIP BLOCCAGGIO POMPA CON CIRCUITO	1	PZ																																																																						

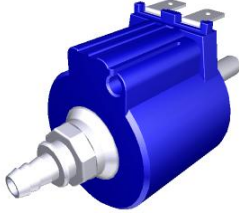
COMPONENTE			RICAMBIO																																																																																		
Codice	Descrizione	Immagine	Codice	Descrizione	Lista componenti																																																																																
VL1019A	POMPA VIBRAZIONE		KVL1109A	KIT IMPIANTO LAVAGGIO ONE 2 GIRANTI EUR	<table border="1"> <thead> <tr> <th>Codice</th> <th>Descrizione</th> <th>Qtà</th> <th>UM</th> </tr> </thead> <tbody> <tr> <td>0H7324A0</td> <td>LAMIERA SUPPORTO LAVAGGIO ON</td> <td>2</td> <td>PZ</td> </tr> <tr> <td>0H7515A0</td> <td>LAMIERA DOPPIO LAVAGGIO XEVC-2011-E1</td> <td>1</td> <td>PZ</td> </tr> <tr> <td>CH1000A0</td> <td>TAGLIATUBI SNIP</td> <td>1</td> <td>PZ</td> </tr> <tr> <td>EL1115A0</td> <td>RACCORDO A Y Ø8 FEMMINA</td> <td>1</td> <td>PZ</td> </tr> <tr> <td>EL1436A0</td> <td>EV H2O JG D8-PORTAGO MMA D6 CHECK VALVE</td> <td>2</td> <td>PZ</td> </tr> <tr> <td>GN1526A0</td> <td>O-RING D.INT6.9 SP1.8</td> <td>2</td> <td>PZ</td> </tr> <tr> <td>RC1006A0</td> <td>CURVA GUIDA TUBO PET D8</td> <td>4</td> <td>PZ</td> </tr> <tr> <td>RC1019A0</td> <td>FASCETTA ELASTICA D10 ZINCATA</td> <td>30</td> <td>PZ</td> </tr> <tr> <td>RC1242A0</td> <td>TERMINALE CHIUSO D10</td> <td>4</td> <td>PZ</td> </tr> <tr> <td>TB1818A0</td> <td>TUBO 8X4.75 PE BLU</td> <td>1.640</td> <td>M</td> </tr> <tr> <td>TB2820A0</td> <td>TUBO EPDM 6X10</td> <td>2.760</td> <td>M</td> </tr> <tr> <td>VH1220A1</td> <td>VITE AUTOFILETTA NTE 4.2X11 TCS+ MARUTE</td> <td>8</td> <td>PZ</td> </tr> <tr> <td>VL1019A0</td> <td>POMPA VIBRAZIONE</td> <td>2</td> <td>PZ</td> </tr> <tr> <td>VL1053B0</td> <td>DISTRIBUTOR E USCITA LAVAGGIO ON</td> <td>2</td> <td>PZ</td> </tr> <tr> <td>VL1054B0</td> <td>DISTRIBUTOR E INGRESSI LAVAGGIO ON</td> <td>2</td> <td>PZ</td> </tr> <tr> <td>VL1080A0</td> <td>FILTRO IN LINEA DETERGENTE</td> <td>2</td> <td>PZ</td> </tr> <tr> <td>VL1081A0</td> <td>VALVOLA NON RITORNO BARBED D6</td> <td>4</td> <td>PZ</td> </tr> <tr> <td>VL1102A0</td> <td>FILTRO IN LINEA CON VNR BARBED 6 MM</td> <td>2</td> <td>PZ</td> </tr> <tr> <td>VL1102A1</td> <td>FILTRO IN LINEA DET. + VNR BARBED 6 MM</td> <td>2</td> <td>PZ</td> </tr> </tbody> </table>	Codice	Descrizione	Qtà	UM	0H7324A0	LAMIERA SUPPORTO LAVAGGIO ON	2	PZ	0H7515A0	LAMIERA DOPPIO LAVAGGIO XEVC-2011-E1	1	PZ	CH1000A0	TAGLIATUBI SNIP	1	PZ	EL1115A0	RACCORDO A Y Ø8 FEMMINA	1	PZ	EL1436A0	EV H2O JG D8-PORTAGO MMA D6 CHECK VALVE	2	PZ	GN1526A0	O-RING D.INT6.9 SP1.8	2	PZ	RC1006A0	CURVA GUIDA TUBO PET D8	4	PZ	RC1019A0	FASCETTA ELASTICA D10 ZINCATA	30	PZ	RC1242A0	TERMINALE CHIUSO D10	4	PZ	TB1818A0	TUBO 8X4.75 PE BLU	1.640	M	TB2820A0	TUBO EPDM 6X10	2.760	M	VH1220A1	VITE AUTOFILETTA NTE 4.2X11 TCS+ MARUTE	8	PZ	VL1019A0	POMPA VIBRAZIONE	2	PZ	VL1053B0	DISTRIBUTOR E USCITA LAVAGGIO ON	2	PZ	VL1054B0	DISTRIBUTOR E INGRESSI LAVAGGIO ON	2	PZ	VL1080A0	FILTRO IN LINEA DETERGENTE	2	PZ	VL1081A0	VALVOLA NON RITORNO BARBED D6	4	PZ	VL1102A0	FILTRO IN LINEA CON VNR BARBED 6 MM	2	PZ	VL1102A1	FILTRO IN LINEA DET. + VNR BARBED 6 MM	2	PZ
Codice	Descrizione	Qtà	UM																																																																																		
0H7324A0	LAMIERA SUPPORTO LAVAGGIO ON	2	PZ																																																																																		
0H7515A0	LAMIERA DOPPIO LAVAGGIO XEVC-2011-E1	1	PZ																																																																																		
CH1000A0	TAGLIATUBI SNIP	1	PZ																																																																																		
EL1115A0	RACCORDO A Y Ø8 FEMMINA	1	PZ																																																																																		
EL1436A0	EV H2O JG D8-PORTAGO MMA D6 CHECK VALVE	2	PZ																																																																																		
GN1526A0	O-RING D.INT6.9 SP1.8	2	PZ																																																																																		
RC1006A0	CURVA GUIDA TUBO PET D8	4	PZ																																																																																		
RC1019A0	FASCETTA ELASTICA D10 ZINCATA	30	PZ																																																																																		
RC1242A0	TERMINALE CHIUSO D10	4	PZ																																																																																		
TB1818A0	TUBO 8X4.75 PE BLU	1.640	M																																																																																		
TB2820A0	TUBO EPDM 6X10	2.760	M																																																																																		
VH1220A1	VITE AUTOFILETTA NTE 4.2X11 TCS+ MARUTE	8	PZ																																																																																		
VL1019A0	POMPA VIBRAZIONE	2	PZ																																																																																		
VL1053B0	DISTRIBUTOR E USCITA LAVAGGIO ON	2	PZ																																																																																		
VL1054B0	DISTRIBUTOR E INGRESSI LAVAGGIO ON	2	PZ																																																																																		
VL1080A0	FILTRO IN LINEA DETERGENTE	2	PZ																																																																																		
VL1081A0	VALVOLA NON RITORNO BARBED D6	4	PZ																																																																																		
VL1102A0	FILTRO IN LINEA CON VNR BARBED 6 MM	2	PZ																																																																																		
VL1102A1	FILTRO IN LINEA DET. + VNR BARBED 6 MM	2	PZ																																																																																		

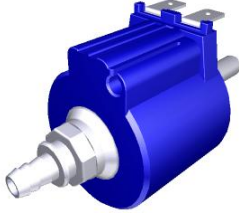
COMPONENTE			RICAMBIO																																																																						
Codice	Descrizione	Immagine	Codice	Descrizione	Lista componenti																																																																				
VL1019A	POMPA VIBRAZIONE		KVL1109A	KIT IMPIANTO LAVAGGIO ONE 2 GIRANTI EUR	<table border="1"> <thead> <tr> <th>Codice</th> <th>Descrizione</th> <th>Qtà</th> <th>UM</th> </tr> </thead> <tbody> <tr> <td>VL1128A0</td> <td>VALVOLA VNR BARBED D6</td> <td>2</td> <td>PZ</td> </tr> <tr> <td>VM2172A0</td> <td>CLIP BLOCCAGGIO POMPA CON CIRCUITO</td> <td>2</td> <td>PZ</td> </tr> </tbody> </table>	Codice	Descrizione	Qtà	UM	VL1128A0	VALVOLA VNR BARBED D6	2	PZ	VM2172A0	CLIP BLOCCAGGIO POMPA CON CIRCUITO	2	PZ																																																								
Codice	Descrizione	Qtà	UM																																																																						
VL1128A0	VALVOLA VNR BARBED D6	2	PZ																																																																						
VM2172A0	CLIP BLOCCAGGIO POMPA CON CIRCUITO	2	PZ																																																																						
			KVL1108A	KIT IMPIANTO LAVAGGIO ONE 04EU 1 GIR EUR	<table border="1"> <thead> <tr> <th>Codice</th> <th>Descrizione</th> <th>Qtà</th> <th>UM</th> </tr> </thead> <tbody> <tr> <td>0H7323A0</td> <td>LAMIERA SUPPORTO LAVAGGIO PLUS</td> <td>1</td> <td>PZ</td> </tr> <tr> <td>0H7511A0</td> <td>LAMIERA SUPPORTO LAVAGGIO ON</td> <td>1</td> <td>PZ</td> </tr> <tr> <td>EL1252A1</td> <td>ELETTROVALV OLA 1 VIA RID.VERDE JG D8-D10</td> <td>1</td> <td>PZ</td> </tr> <tr> <td>EL1424A0</td> <td>ELETTROVALV OLA H2O JG D8-PORTAGO MMA D6</td> <td>1</td> <td>PZ</td> </tr> <tr> <td>EL1436A0</td> <td>EV H2O JG D8-PORTAGO MMA D6 CHECK VALVE</td> <td>1</td> <td>PZ</td> </tr> <tr> <td>GN1526A0</td> <td>O-RING D.INT6.9 SP1.8</td> <td>1</td> <td>PZ</td> </tr> <tr> <td>RC1006A0</td> <td>CURVA GUIDA TUBO PET D8</td> <td>2</td> <td>PZ</td> </tr> <tr> <td>RC1019A0</td> <td>FASCETTA ELASTICA D10 ZINCATA</td> <td>11</td> <td>PZ</td> </tr> <tr> <td>RC1130A0</td> <td>FASCETTA 130X2,6</td> <td>1</td> <td>PZ</td> </tr> <tr> <td>RC1242A0</td> <td>TERMINALE CHIUSO D10</td> <td>2</td> <td>PZ</td> </tr> <tr> <td>RC1310A0</td> <td>FASCETTA RICHCO 140X4 CON CLIP</td> <td>2</td> <td>PZ</td> </tr> <tr> <td>RC1356A0</td> <td>RACCORDO DRITTO FIL. FEMM 8X1/4 BSP</td> <td>1</td> <td>PZ</td> </tr> <tr> <td>TB1818A0</td> <td>TUBO 8X4.75 PE BLU</td> <td>0.220</td> <td>M</td> </tr> <tr> <td>TB2820A0</td> <td>TUBO EPDM 6X10</td> <td>1.240</td> <td>M</td> </tr> <tr> <td>VI1220A1</td> <td>VITE AUTOFILETTA NTE 4.2X11 TCS+ MARUTE</td> <td>2</td> <td>PZ</td> </tr> <tr> <td>VL1019A0</td> <td>POMPA VIBRAZIONE</td> <td>1</td> <td>PZ</td> </tr> </tbody> </table>	Codice	Descrizione	Qtà	UM	0H7323A0	LAMIERA SUPPORTO LAVAGGIO PLUS	1	PZ	0H7511A0	LAMIERA SUPPORTO LAVAGGIO ON	1	PZ	EL1252A1	ELETTROVALV OLA 1 VIA RID.VERDE JG D8-D10	1	PZ	EL1424A0	ELETTROVALV OLA H2O JG D8-PORTAGO MMA D6	1	PZ	EL1436A0	EV H2O JG D8-PORTAGO MMA D6 CHECK VALVE	1	PZ	GN1526A0	O-RING D.INT6.9 SP1.8	1	PZ	RC1006A0	CURVA GUIDA TUBO PET D8	2	PZ	RC1019A0	FASCETTA ELASTICA D10 ZINCATA	11	PZ	RC1130A0	FASCETTA 130X2,6	1	PZ	RC1242A0	TERMINALE CHIUSO D10	2	PZ	RC1310A0	FASCETTA RICHCO 140X4 CON CLIP	2	PZ	RC1356A0	RACCORDO DRITTO FIL. FEMM 8X1/4 BSP	1	PZ	TB1818A0	TUBO 8X4.75 PE BLU	0.220	M	TB2820A0	TUBO EPDM 6X10	1.240	M	VI1220A1	VITE AUTOFILETTA NTE 4.2X11 TCS+ MARUTE	2	PZ	VL1019A0	POMPA VIBRAZIONE	1	PZ
Codice	Descrizione	Qtà	UM																																																																						
0H7323A0	LAMIERA SUPPORTO LAVAGGIO PLUS	1	PZ																																																																						
0H7511A0	LAMIERA SUPPORTO LAVAGGIO ON	1	PZ																																																																						
EL1252A1	ELETTROVALV OLA 1 VIA RID.VERDE JG D8-D10	1	PZ																																																																						
EL1424A0	ELETTROVALV OLA H2O JG D8-PORTAGO MMA D6	1	PZ																																																																						
EL1436A0	EV H2O JG D8-PORTAGO MMA D6 CHECK VALVE	1	PZ																																																																						
GN1526A0	O-RING D.INT6.9 SP1.8	1	PZ																																																																						
RC1006A0	CURVA GUIDA TUBO PET D8	2	PZ																																																																						
RC1019A0	FASCETTA ELASTICA D10 ZINCATA	11	PZ																																																																						
RC1130A0	FASCETTA 130X2,6	1	PZ																																																																						
RC1242A0	TERMINALE CHIUSO D10	2	PZ																																																																						
RC1310A0	FASCETTA RICHCO 140X4 CON CLIP	2	PZ																																																																						
RC1356A0	RACCORDO DRITTO FIL. FEMM 8X1/4 BSP	1	PZ																																																																						
TB1818A0	TUBO 8X4.75 PE BLU	0.220	M																																																																						
TB2820A0	TUBO EPDM 6X10	1.240	M																																																																						
VI1220A1	VITE AUTOFILETTA NTE 4.2X11 TCS+ MARUTE	2	PZ																																																																						
VL1019A0	POMPA VIBRAZIONE	1	PZ																																																																						

COMPONENTE			RICAMBIO																																																		
Codice	Descrizione	Immagine	Codice	Descrizione	Lista componenti																																																
VL1019A	POMPA VIBRAZIONE		KVL1108A	KIT IMPIANTO LAVAGGIO ONE 04EU 1 GIR EUR	<table border="1"> <thead> <tr> <th>Codice</th> <th>Descrizione</th> <th>Qtà</th> <th>UM</th> </tr> </thead> <tbody> <tr> <td>VL1053B0</td> <td>DISTRIBUTOR E USCITA LAVAGGIO ON</td> <td>1</td> <td>PZ</td> </tr> <tr> <td>VL1054B0</td> <td>DISTRIBUTOR E INGRESSI LAVAGGIO ON</td> <td>1</td> <td>PZ</td> </tr> <tr> <td>VL1064A0</td> <td>DISTRIBUTOR E USCITE CIRCUITO LAVAGGIO PL</td> <td>1</td> <td>PZ</td> </tr> <tr> <td>VL1065A1</td> <td>PRESSOSTAT O.N.O. 1/4 M CI</td> <td>1</td> <td>PZ</td> </tr> <tr> <td>VL1067A0</td> <td>DISTRIBUTOR E INGRESSI CIRCUITO LAVAGGIO</td> <td>1</td> <td>PZ</td> </tr> <tr> <td>VL1080A0</td> <td>FILTRO IN LINEA DETERGENTE</td> <td>1</td> <td>PZ</td> </tr> <tr> <td>VL1081A0</td> <td>VALVOLA NON RITORNO BARBED D6</td> <td>2</td> <td>PZ</td> </tr> <tr> <td>VL1083A0</td> <td>RACCORDO D10 - PORTAGOMM A BARBED D6</td> <td>1</td> <td>PZ</td> </tr> <tr> <td>VL1102A0</td> <td>FILTRO IN LINEA CON VNR BARBED 6 MM</td> <td>1</td> <td>PZ</td> </tr> <tr> <td>VL1128A0</td> <td>VALVOLA VNR BARBED D6</td> <td>1</td> <td>PZ</td> </tr> <tr> <td>VM2172A0</td> <td>CLIP BLOCCAGGIO POMPA CON CIRCUITO</td> <td>1</td> <td>PZ</td> </tr> </tbody> </table>	Codice	Descrizione	Qtà	UM	VL1053B0	DISTRIBUTOR E USCITA LAVAGGIO ON	1	PZ	VL1054B0	DISTRIBUTOR E INGRESSI LAVAGGIO ON	1	PZ	VL1064A0	DISTRIBUTOR E USCITE CIRCUITO LAVAGGIO PL	1	PZ	VL1065A1	PRESSOSTAT O.N.O. 1/4 M CI	1	PZ	VL1067A0	DISTRIBUTOR E INGRESSI CIRCUITO LAVAGGIO	1	PZ	VL1080A0	FILTRO IN LINEA DETERGENTE	1	PZ	VL1081A0	VALVOLA NON RITORNO BARBED D6	2	PZ	VL1083A0	RACCORDO D10 - PORTAGOMM A BARBED D6	1	PZ	VL1102A0	FILTRO IN LINEA CON VNR BARBED 6 MM	1	PZ	VL1128A0	VALVOLA VNR BARBED D6	1	PZ	VM2172A0	CLIP BLOCCAGGIO POMPA CON CIRCUITO	1	PZ
Codice	Descrizione	Qtà	UM																																																		
VL1053B0	DISTRIBUTOR E USCITA LAVAGGIO ON	1	PZ																																																		
VL1054B0	DISTRIBUTOR E INGRESSI LAVAGGIO ON	1	PZ																																																		
VL1064A0	DISTRIBUTOR E USCITE CIRCUITO LAVAGGIO PL	1	PZ																																																		
VL1065A1	PRESSOSTAT O.N.O. 1/4 M CI	1	PZ																																																		
VL1067A0	DISTRIBUTOR E INGRESSI CIRCUITO LAVAGGIO	1	PZ																																																		
VL1080A0	FILTRO IN LINEA DETERGENTE	1	PZ																																																		
VL1081A0	VALVOLA NON RITORNO BARBED D6	2	PZ																																																		
VL1083A0	RACCORDO D10 - PORTAGOMM A BARBED D6	1	PZ																																																		
VL1102A0	FILTRO IN LINEA CON VNR BARBED 6 MM	1	PZ																																																		
VL1128A0	VALVOLA VNR BARBED D6	1	PZ																																																		
VM2172A0	CLIP BLOCCAGGIO POMPA CON CIRCUITO	1	PZ																																																		
			KVL1107A	KIT IMPIANTO LAVAGGIO PLUS 04EU 1 GIR EU	<table border="1"> <thead> <tr> <th>Codice</th> <th>Descrizione</th> <th>Qtà</th> <th>UM</th> </tr> </thead> <tbody> <tr> <td>0H7323A0</td> <td>LAMIERA SUPPORTO LAVAGGIO PLUS</td> <td>1</td> <td>PZ</td> </tr> <tr> <td>EL1252A1</td> <td>ELETTROVALV OLA 1 VIA RID.VERDE JG D8-D10</td> <td>1</td> <td>PZ</td> </tr> <tr> <td>EL1424A0</td> <td>ELETTROVALV OLA H2O JG D8-PORTAGO MMA D6</td> <td>1</td> <td>PZ</td> </tr> <tr> <td>EL1436A0</td> <td>EV H2O JG D8-PORTAGO MMA D6 CHECK VALVE</td> <td>1</td> <td>PZ</td> </tr> </tbody> </table>	Codice	Descrizione	Qtà	UM	0H7323A0	LAMIERA SUPPORTO LAVAGGIO PLUS	1	PZ	EL1252A1	ELETTROVALV OLA 1 VIA RID.VERDE JG D8-D10	1	PZ	EL1424A0	ELETTROVALV OLA H2O JG D8-PORTAGO MMA D6	1	PZ	EL1436A0	EV H2O JG D8-PORTAGO MMA D6 CHECK VALVE	1	PZ																												
Codice	Descrizione	Qtà	UM																																																		
0H7323A0	LAMIERA SUPPORTO LAVAGGIO PLUS	1	PZ																																																		
EL1252A1	ELETTROVALV OLA 1 VIA RID.VERDE JG D8-D10	1	PZ																																																		
EL1424A0	ELETTROVALV OLA H2O JG D8-PORTAGO MMA D6	1	PZ																																																		
EL1436A0	EV H2O JG D8-PORTAGO MMA D6 CHECK VALVE	1	PZ																																																		

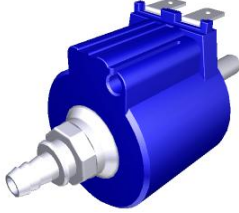
COMPONENTE			RICAMBIO																																																																																		
Codice	Descrizione	Immagine	Codice	Descrizione	Lista componenti																																																																																
VL1019A	POMPA VIBRAZIONE		KVL1107A	KIT IMPIANTO LAVAGGIO PLUS 04EU 1 GIR EU	<table border="1"> <thead> <tr> <th>Codice</th> <th>Descrizione</th> <th>Qtà</th> <th>UM</th> </tr> </thead> <tbody> <tr> <td>GN1526A0</td> <td>O-RING D.INT6.9 SP1.8</td> <td>1</td> <td>PZ</td> </tr> <tr> <td>RC1019A0</td> <td>FASCETTA ELASTICA D10 ZINCATA</td> <td>11</td> <td>PZ</td> </tr> <tr> <td>RC1130A0</td> <td>FASCETTA 130X2,6</td> <td>1</td> <td>PZ</td> </tr> <tr> <td>RC1242A0</td> <td>TERMINALE CHIUSO D10</td> <td>2</td> <td>PZ</td> </tr> <tr> <td>RC1310A0</td> <td>FASCETTA RICHCO 140X4 CON CLIP</td> <td>2</td> <td>PZ</td> </tr> <tr> <td>RC1356A0</td> <td>RACCORDO DRITTO FIL. FEMM 8X1/4 BSP</td> <td>1</td> <td>PZ</td> </tr> <tr> <td>TB2820A0</td> <td>TUBO EPDM 6X10</td> <td>2.040</td> <td>M</td> </tr> <tr> <td>VI1220A1</td> <td>VITE AUTOFILETTA NTE 4.2X11 TCS+ MARUTE</td> <td>2</td> <td>PZ</td> </tr> <tr> <td>VL1019A0</td> <td>POMPA VIBRAZIONE</td> <td>1</td> <td>PZ</td> </tr> <tr> <td>VL1064A0</td> <td>DISTRIBUTOR E USCITE CIRCUITO LAVAGGIO PL</td> <td>1</td> <td>PZ</td> </tr> <tr> <td>VL1065A1</td> <td>PRESSOSTAT O.N.O. 1/4 M CI</td> <td>1</td> <td>PZ</td> </tr> <tr> <td>VL1067A0</td> <td>DISTRIBUTOR E INGRESSI CIRCUITO LAVAGGIO</td> <td>1</td> <td>PZ</td> </tr> <tr> <td>VL1080A0</td> <td>FILTRO IN LINEA DETERGENTE</td> <td>1</td> <td>PZ</td> </tr> <tr> <td>VL1081A0</td> <td>VALVOLA NON RITORNO BARBED D6</td> <td>2</td> <td>PZ</td> </tr> <tr> <td>VL1083A0</td> <td>RACCORDO D10 - PORTAGOMM A BARBED D6</td> <td>1</td> <td>PZ</td> </tr> <tr> <td>VL1102A0</td> <td>FILTRO IN LINEA CON VNR BARBED 6 MM</td> <td>1</td> <td>PZ</td> </tr> <tr> <td>VL1102A1</td> <td>FILTRO IN LINEA DET. + VNR BARBED 6 MM</td> <td>1</td> <td>PZ</td> </tr> <tr> <td>VL1128A0</td> <td>VALVOLA VNR BARBED D6</td> <td>1</td> <td>PZ</td> </tr> <tr> <td>VM2172A0</td> <td>CLIP BLOCCAGGIO POMPA CON CIRCUITO</td> <td>1</td> <td>PZ</td> </tr> </tbody> </table>	Codice	Descrizione	Qtà	UM	GN1526A0	O-RING D.INT6.9 SP1.8	1	PZ	RC1019A0	FASCETTA ELASTICA D10 ZINCATA	11	PZ	RC1130A0	FASCETTA 130X2,6	1	PZ	RC1242A0	TERMINALE CHIUSO D10	2	PZ	RC1310A0	FASCETTA RICHCO 140X4 CON CLIP	2	PZ	RC1356A0	RACCORDO DRITTO FIL. FEMM 8X1/4 BSP	1	PZ	TB2820A0	TUBO EPDM 6X10	2.040	M	VI1220A1	VITE AUTOFILETTA NTE 4.2X11 TCS+ MARUTE	2	PZ	VL1019A0	POMPA VIBRAZIONE	1	PZ	VL1064A0	DISTRIBUTOR E USCITE CIRCUITO LAVAGGIO PL	1	PZ	VL1065A1	PRESSOSTAT O.N.O. 1/4 M CI	1	PZ	VL1067A0	DISTRIBUTOR E INGRESSI CIRCUITO LAVAGGIO	1	PZ	VL1080A0	FILTRO IN LINEA DETERGENTE	1	PZ	VL1081A0	VALVOLA NON RITORNO BARBED D6	2	PZ	VL1083A0	RACCORDO D10 - PORTAGOMM A BARBED D6	1	PZ	VL1102A0	FILTRO IN LINEA CON VNR BARBED 6 MM	1	PZ	VL1102A1	FILTRO IN LINEA DET. + VNR BARBED 6 MM	1	PZ	VL1128A0	VALVOLA VNR BARBED D6	1	PZ	VM2172A0	CLIP BLOCCAGGIO POMPA CON CIRCUITO	1	PZ
Codice	Descrizione	Qtà	UM																																																																																		
GN1526A0	O-RING D.INT6.9 SP1.8	1	PZ																																																																																		
RC1019A0	FASCETTA ELASTICA D10 ZINCATA	11	PZ																																																																																		
RC1130A0	FASCETTA 130X2,6	1	PZ																																																																																		
RC1242A0	TERMINALE CHIUSO D10	2	PZ																																																																																		
RC1310A0	FASCETTA RICHCO 140X4 CON CLIP	2	PZ																																																																																		
RC1356A0	RACCORDO DRITTO FIL. FEMM 8X1/4 BSP	1	PZ																																																																																		
TB2820A0	TUBO EPDM 6X10	2.040	M																																																																																		
VI1220A1	VITE AUTOFILETTA NTE 4.2X11 TCS+ MARUTE	2	PZ																																																																																		
VL1019A0	POMPA VIBRAZIONE	1	PZ																																																																																		
VL1064A0	DISTRIBUTOR E USCITE CIRCUITO LAVAGGIO PL	1	PZ																																																																																		
VL1065A1	PRESSOSTAT O.N.O. 1/4 M CI	1	PZ																																																																																		
VL1067A0	DISTRIBUTOR E INGRESSI CIRCUITO LAVAGGIO	1	PZ																																																																																		
VL1080A0	FILTRO IN LINEA DETERGENTE	1	PZ																																																																																		
VL1081A0	VALVOLA NON RITORNO BARBED D6	2	PZ																																																																																		
VL1083A0	RACCORDO D10 - PORTAGOMM A BARBED D6	1	PZ																																																																																		
VL1102A0	FILTRO IN LINEA CON VNR BARBED 6 MM	1	PZ																																																																																		
VL1102A1	FILTRO IN LINEA DET. + VNR BARBED 6 MM	1	PZ																																																																																		
VL1128A0	VALVOLA VNR BARBED D6	1	PZ																																																																																		
VM2172A0	CLIP BLOCCAGGIO POMPA CON CIRCUITO	1	PZ																																																																																		

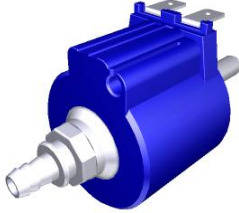
COMPONENTE			RICAMBIO																																																																														
Codice	Descrizione	Immagine	Codice	Descrizione	Lista componenti																																																																												
VL1019A	POMPA VIBRAZIONE		KVL1106A	KIT IMPIANTO LAVAGGIO ONE 1 GIRANTE EUR	<table border="1"> <thead> <tr> <th>Codice</th> <th>Descrizione</th> <th>Qtà</th> <th>UM</th> </tr> </thead> <tbody> <tr> <td>0H7324A0</td> <td>LAMIERA SUPPORTO LAVAGGIO ON</td> <td>1</td> <td>PZ</td> </tr> <tr> <td>0H7819A0</td> <td>SUPPORTO LAVAGGIO ONE CON ELV STEAM</td> <td>1</td> <td>PZ</td> </tr> <tr> <td>EL1436A0</td> <td>EV H2O JG D8-PORTAGO MMA D6 CHECK VALVE</td> <td>1</td> <td>PZ</td> </tr> <tr> <td>GN1526A0</td> <td>O-RING D.INT6.9 SP1.8</td> <td>1</td> <td>PZ</td> </tr> <tr> <td>RC1006A0</td> <td>CURVA GUIDA TUBO PET D8</td> <td>2</td> <td>PZ</td> </tr> <tr> <td>RC1019A0</td> <td>FASCETTA ELASTICA D10 ZINCATA</td> <td>15</td> <td>PZ</td> </tr> <tr> <td>RC1242A0</td> <td>TERMINALE CHIUSO D10</td> <td>2</td> <td>PZ</td> </tr> <tr> <td>RC1408A0</td> <td>FASCETTA BIFILARE A MOLLA D10.8 TUBO ZN</td> <td>2</td> <td>PZ</td> </tr> <tr> <td>TB1818A0</td> <td>TUBO 8X4.75 PE BLU</td> <td>0.320</td> <td>M</td> </tr> <tr> <td>TB2820A0</td> <td>TUBO EPDM 6X10</td> <td>1.380</td> <td>M</td> </tr> <tr> <td>VH1220A1</td> <td>VITE AUTOFILETTA NTE 4.2X11 TCS+ MARUTE</td> <td>1</td> <td>PZ</td> </tr> <tr> <td>VL1019A0</td> <td>POMPA VIBRAZIONE</td> <td>1</td> <td>PZ</td> </tr> <tr> <td>VL1053B0</td> <td>DISTRIBUTOR E USCITA LAVAGGIO ON</td> <td>1</td> <td>PZ</td> </tr> <tr> <td>VL1054B0</td> <td>DISTRIBUTOR E INGRESSI LAVAGGIO ON</td> <td>1</td> <td>PZ</td> </tr> <tr> <td>VL1080A0</td> <td>FILTRO IN LINEA DETERGENTE</td> <td>1</td> <td>PZ</td> </tr> <tr> <td>VL1081A0</td> <td>VALVOLA NON RITORNO BARBED D6</td> <td>1</td> <td>PZ</td> </tr> <tr> <td>VL1102A0</td> <td>FILTRO IN LINEA CON VNR BARBED 6 MM</td> <td>1</td> <td>PZ</td> </tr> <tr> <td>VL1102A1</td> <td>FILTRO IN LINEA DET. + VNR BARBED 6 MM</td> <td>1</td> <td>PZ</td> </tr> </tbody> </table>	Codice	Descrizione	Qtà	UM	0H7324A0	LAMIERA SUPPORTO LAVAGGIO ON	1	PZ	0H7819A0	SUPPORTO LAVAGGIO ONE CON ELV STEAM	1	PZ	EL1436A0	EV H2O JG D8-PORTAGO MMA D6 CHECK VALVE	1	PZ	GN1526A0	O-RING D.INT6.9 SP1.8	1	PZ	RC1006A0	CURVA GUIDA TUBO PET D8	2	PZ	RC1019A0	FASCETTA ELASTICA D10 ZINCATA	15	PZ	RC1242A0	TERMINALE CHIUSO D10	2	PZ	RC1408A0	FASCETTA BIFILARE A MOLLA D10.8 TUBO ZN	2	PZ	TB1818A0	TUBO 8X4.75 PE BLU	0.320	M	TB2820A0	TUBO EPDM 6X10	1.380	M	VH1220A1	VITE AUTOFILETTA NTE 4.2X11 TCS+ MARUTE	1	PZ	VL1019A0	POMPA VIBRAZIONE	1	PZ	VL1053B0	DISTRIBUTOR E USCITA LAVAGGIO ON	1	PZ	VL1054B0	DISTRIBUTOR E INGRESSI LAVAGGIO ON	1	PZ	VL1080A0	FILTRO IN LINEA DETERGENTE	1	PZ	VL1081A0	VALVOLA NON RITORNO BARBED D6	1	PZ	VL1102A0	FILTRO IN LINEA CON VNR BARBED 6 MM	1	PZ	VL1102A1	FILTRO IN LINEA DET. + VNR BARBED 6 MM	1	PZ
Codice	Descrizione	Qtà	UM																																																																														
0H7324A0	LAMIERA SUPPORTO LAVAGGIO ON	1	PZ																																																																														
0H7819A0	SUPPORTO LAVAGGIO ONE CON ELV STEAM	1	PZ																																																																														
EL1436A0	EV H2O JG D8-PORTAGO MMA D6 CHECK VALVE	1	PZ																																																																														
GN1526A0	O-RING D.INT6.9 SP1.8	1	PZ																																																																														
RC1006A0	CURVA GUIDA TUBO PET D8	2	PZ																																																																														
RC1019A0	FASCETTA ELASTICA D10 ZINCATA	15	PZ																																																																														
RC1242A0	TERMINALE CHIUSO D10	2	PZ																																																																														
RC1408A0	FASCETTA BIFILARE A MOLLA D10.8 TUBO ZN	2	PZ																																																																														
TB1818A0	TUBO 8X4.75 PE BLU	0.320	M																																																																														
TB2820A0	TUBO EPDM 6X10	1.380	M																																																																														
VH1220A1	VITE AUTOFILETTA NTE 4.2X11 TCS+ MARUTE	1	PZ																																																																														
VL1019A0	POMPA VIBRAZIONE	1	PZ																																																																														
VL1053B0	DISTRIBUTOR E USCITA LAVAGGIO ON	1	PZ																																																																														
VL1054B0	DISTRIBUTOR E INGRESSI LAVAGGIO ON	1	PZ																																																																														
VL1080A0	FILTRO IN LINEA DETERGENTE	1	PZ																																																																														
VL1081A0	VALVOLA NON RITORNO BARBED D6	1	PZ																																																																														
VL1102A0	FILTRO IN LINEA CON VNR BARBED 6 MM	1	PZ																																																																														
VL1102A1	FILTRO IN LINEA DET. + VNR BARBED 6 MM	1	PZ																																																																														

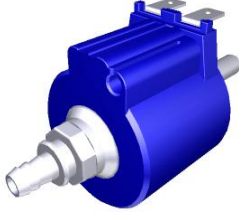
COMPONENTE			RICAMBIO																																																											
Codice	Descrizione	Immagine	Codice	Descrizione	Lista componenti																																																									
VL1019A	POMPA VIBRAZIONE		KVL1106A	KIT IMPIANTO LAVAGGIO ONE 1 GIRANTE EUR	<table border="1"> <thead> <tr> <th>Codice</th> <th>Descrizione</th> <th>Qtà</th> <th>UM</th> </tr> </thead> <tbody> <tr> <td>VL1128A0</td> <td>VALVOLA VNR BARBED D6</td> <td>1</td> <td>PZ</td> </tr> <tr> <td>VM2172A0</td> <td>CLIP BLOCCAGGIO POMPA CON CIRCUITO</td> <td>1</td> <td>PZ</td> </tr> </tbody> </table>	Codice	Descrizione	Qtà	UM	VL1128A0	VALVOLA VNR BARBED D6	1	PZ	VM2172A0	CLIP BLOCCAGGIO POMPA CON CIRCUITO	1	PZ																																													
			Codice	Descrizione	Qtà	UM																																																								
VL1128A0	VALVOLA VNR BARBED D6	1	PZ																																																											
VM2172A0	CLIP BLOCCAGGIO POMPA CON CIRCUITO	1	PZ																																																											
KVL1105A	KIT IMPIANTO LAVAGGIO PLUS 2 GIRANTI USA	<table border="1"> <thead> <tr> <th>Codice</th> <th>Descrizione</th> <th>Qtà</th> <th>UM</th> </tr> </thead> <tbody> <tr> <td>0H7323A0</td> <td>LAMIERA SUPPORTO LAVAGGIO PLUS</td> <td>1</td> <td>PZ</td> </tr> <tr> <td>0H7820A0</td> <td>SUPPORTO LAVAGGIO PLUS CON ELV STEAM</td> <td>1</td> <td>PZ</td> </tr> <tr> <td>EL1020A1</td> <td>RACCORDO INTERMEDIO "T" TUBO D8 J</td> <td>1</td> <td>PZ</td> </tr> <tr> <td>EL1422A0</td> <td>ELETTROVALV 1 VIA RID.VERDE JG D8-D10 UL</td> <td>1</td> <td>PZ</td> </tr> <tr> <td>EL1422A1</td> <td>ELETTROVALV 1 VIA RID.VERDE JG D8-D10 UL</td> <td>1</td> <td>PZ</td> </tr> <tr> <td>EL1426A0</td> <td>ELETTROVALV OLA UL H2O JG D8-PORTAGO MMA D</td> <td>2</td> <td>PZ</td> </tr> <tr> <td>EL1437A0</td> <td>EV H2O JG D8-PORTAGO MMA D6 CH. VALVE UL</td> <td>1</td> <td>PZ</td> </tr> <tr> <td>GN1526A0</td> <td>O-RING D.INT6.9 SP1.8</td> <td>1</td> <td>PZ</td> </tr> <tr> <td>RC1019A0</td> <td>FASCETTA ELASTICA D10 ZINCATA</td> <td>12</td> <td>PZ</td> </tr> <tr> <td>RC1130A0</td> <td>FASCETTA 130X2,6</td> <td>1</td> <td>PZ</td> </tr> <tr> <td>RC1242A0</td> <td>TERMINALE CHIUSO D10</td> <td>2</td> <td>PZ</td> </tr> <tr> <td>RC1310A0</td> <td>FASCETTA RICHCO 140X4 CON CLIP</td> <td>2</td> <td>PZ</td> </tr> <tr> <td>RC1356A0</td> <td>RACCORDO DRITTO FIL. FEMM 8X1/4 BSP</td> <td>1</td> <td>PZ</td> </tr> <tr> <td>RC1408A0</td> <td>FASCETTA BIFILARE A MOLLA D10.8 TUBO ZN</td> <td>2</td> <td>PZ</td> </tr> </tbody> </table>	Codice	Descrizione	Qtà	UM	0H7323A0	LAMIERA SUPPORTO LAVAGGIO PLUS	1	PZ	0H7820A0	SUPPORTO LAVAGGIO PLUS CON ELV STEAM	1	PZ	EL1020A1	RACCORDO INTERMEDIO "T" TUBO D8 J	1	PZ	EL1422A0	ELETTROVALV 1 VIA RID.VERDE JG D8-D10 UL	1	PZ	EL1422A1	ELETTROVALV 1 VIA RID.VERDE JG D8-D10 UL	1	PZ	EL1426A0	ELETTROVALV OLA UL H2O JG D8-PORTAGO MMA D	2	PZ	EL1437A0	EV H2O JG D8-PORTAGO MMA D6 CH. VALVE UL	1	PZ	GN1526A0	O-RING D.INT6.9 SP1.8	1	PZ	RC1019A0	FASCETTA ELASTICA D10 ZINCATA	12	PZ	RC1130A0	FASCETTA 130X2,6	1	PZ	RC1242A0	TERMINALE CHIUSO D10	2	PZ	RC1310A0	FASCETTA RICHCO 140X4 CON CLIP	2	PZ	RC1356A0	RACCORDO DRITTO FIL. FEMM 8X1/4 BSP	1	PZ	RC1408A0	FASCETTA BIFILARE A MOLLA D10.8 TUBO ZN	2	PZ
Codice	Descrizione	Qtà	UM																																																											
0H7323A0	LAMIERA SUPPORTO LAVAGGIO PLUS	1	PZ																																																											
0H7820A0	SUPPORTO LAVAGGIO PLUS CON ELV STEAM	1	PZ																																																											
EL1020A1	RACCORDO INTERMEDIO "T" TUBO D8 J	1	PZ																																																											
EL1422A0	ELETTROVALV 1 VIA RID.VERDE JG D8-D10 UL	1	PZ																																																											
EL1422A1	ELETTROVALV 1 VIA RID.VERDE JG D8-D10 UL	1	PZ																																																											
EL1426A0	ELETTROVALV OLA UL H2O JG D8-PORTAGO MMA D	2	PZ																																																											
EL1437A0	EV H2O JG D8-PORTAGO MMA D6 CH. VALVE UL	1	PZ																																																											
GN1526A0	O-RING D.INT6.9 SP1.8	1	PZ																																																											
RC1019A0	FASCETTA ELASTICA D10 ZINCATA	12	PZ																																																											
RC1130A0	FASCETTA 130X2,6	1	PZ																																																											
RC1242A0	TERMINALE CHIUSO D10	2	PZ																																																											
RC1310A0	FASCETTA RICHCO 140X4 CON CLIP	2	PZ																																																											
RC1356A0	RACCORDO DRITTO FIL. FEMM 8X1/4 BSP	1	PZ																																																											
RC1408A0	FASCETTA BIFILARE A MOLLA D10.8 TUBO ZN	2	PZ																																																											

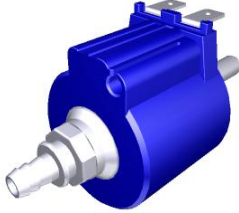
COMPONENTE			RICAMBIO																																																														
Codice	Descrizione	Immagine	Codice	Descrizione	Lista componenti																																																												
VL1019A	POMPA VIBRAZIONE		KVL1105A	KIT IMPIANTO LAVAGGIO PLUS 2 GIRANTI USA	<table border="1"> <thead> <tr> <th>Codice</th> <th>Descrizione</th> <th>Qtà</th> <th>UM</th> </tr> </thead> <tbody> <tr> <td>TB1818A0</td> <td>TUBO 8X4.75 PE BLU</td> <td>0.300</td> <td>M</td> </tr> <tr> <td>TB2820A0</td> <td>TUBO EPDM 6X10</td> <td>2.040</td> <td>M</td> </tr> <tr> <td>VI1220A1</td> <td>VITE AUTOFILETTA NTE 4.2X11 TCS+ MARUTE</td> <td>2</td> <td>PZ</td> </tr> <tr> <td>VL1019A0</td> <td>POMPA VIBRAZIONE</td> <td>1</td> <td>PZ</td> </tr> <tr> <td>VL1065A1</td> <td>PRESSOSTAT O.N.O. 1/4 M CI</td> <td>1</td> <td>PZ</td> </tr> <tr> <td>VL1067A0</td> <td>DISTRIBUTOR E INGRESSI CIRCUITO LAVAGGIO</td> <td>1</td> <td>PZ</td> </tr> <tr> <td>VL1080A0</td> <td>FILTRO IN LINEA DETERGENTE</td> <td>1</td> <td>PZ</td> </tr> <tr> <td>VL1081A0</td> <td>VALVOLA NON RITORNO BARBED D6</td> <td>2</td> <td>PZ</td> </tr> <tr> <td>VL1083A0</td> <td>RACCORDO D10 - PORTAGOMM A BARBED D6</td> <td>1</td> <td>PZ</td> </tr> <tr> <td>VL1092A0</td> <td>DISTRIBUTOR E USCITE LAVAGGIO PLUS DOPPIA</td> <td>1</td> <td>PZ</td> </tr> <tr> <td>VL1102A0</td> <td>FILTRO IN LINEA CON VNR BARBED 6 MM</td> <td>1</td> <td>PZ</td> </tr> <tr> <td>VL1102A1</td> <td>FILTRO IN LINEA DET. + VNR BARBED 6 MM</td> <td>1</td> <td>PZ</td> </tr> <tr> <td>VL1128A0</td> <td>VALVOLA VNR BARBED D6</td> <td>1</td> <td>PZ</td> </tr> <tr> <td>VM2172A0</td> <td>CLIP BLOCCAGGIO POMPA CON CIRCUITO</td> <td>1</td> <td>PZ</td> </tr> </tbody> </table>	Codice	Descrizione	Qtà	UM	TB1818A0	TUBO 8X4.75 PE BLU	0.300	M	TB2820A0	TUBO EPDM 6X10	2.040	M	VI1220A1	VITE AUTOFILETTA NTE 4.2X11 TCS+ MARUTE	2	PZ	VL1019A0	POMPA VIBRAZIONE	1	PZ	VL1065A1	PRESSOSTAT O.N.O. 1/4 M CI	1	PZ	VL1067A0	DISTRIBUTOR E INGRESSI CIRCUITO LAVAGGIO	1	PZ	VL1080A0	FILTRO IN LINEA DETERGENTE	1	PZ	VL1081A0	VALVOLA NON RITORNO BARBED D6	2	PZ	VL1083A0	RACCORDO D10 - PORTAGOMM A BARBED D6	1	PZ	VL1092A0	DISTRIBUTOR E USCITE LAVAGGIO PLUS DOPPIA	1	PZ	VL1102A0	FILTRO IN LINEA CON VNR BARBED 6 MM	1	PZ	VL1102A1	FILTRO IN LINEA DET. + VNR BARBED 6 MM	1	PZ	VL1128A0	VALVOLA VNR BARBED D6	1	PZ	VM2172A0	CLIP BLOCCAGGIO POMPA CON CIRCUITO	1	PZ
Codice	Descrizione	Qtà	UM																																																														
TB1818A0	TUBO 8X4.75 PE BLU	0.300	M																																																														
TB2820A0	TUBO EPDM 6X10	2.040	M																																																														
VI1220A1	VITE AUTOFILETTA NTE 4.2X11 TCS+ MARUTE	2	PZ																																																														
VL1019A0	POMPA VIBRAZIONE	1	PZ																																																														
VL1065A1	PRESSOSTAT O.N.O. 1/4 M CI	1	PZ																																																														
VL1067A0	DISTRIBUTOR E INGRESSI CIRCUITO LAVAGGIO	1	PZ																																																														
VL1080A0	FILTRO IN LINEA DETERGENTE	1	PZ																																																														
VL1081A0	VALVOLA NON RITORNO BARBED D6	2	PZ																																																														
VL1083A0	RACCORDO D10 - PORTAGOMM A BARBED D6	1	PZ																																																														
VL1092A0	DISTRIBUTOR E USCITE LAVAGGIO PLUS DOPPIA	1	PZ																																																														
VL1102A0	FILTRO IN LINEA CON VNR BARBED 6 MM	1	PZ																																																														
VL1102A1	FILTRO IN LINEA DET. + VNR BARBED 6 MM	1	PZ																																																														
VL1128A0	VALVOLA VNR BARBED D6	1	PZ																																																														
VM2172A0	CLIP BLOCCAGGIO POMPA CON CIRCUITO	1	PZ																																																														
			KVL1104A	KIT IMPIANTO LAVAGGIO PLUS 1 GIRANTE USA	<table border="1"> <thead> <tr> <th>Codice</th> <th>Descrizione</th> <th>Qtà</th> <th>UM</th> </tr> </thead> <tbody> <tr> <td>0H7323A0</td> <td>LAMIERA SUPPORTO LAVAGGIO PLUS</td> <td>1</td> <td>PZ</td> </tr> <tr> <td>0H7820A0</td> <td>SUPPORTO LAVAGGIO PLUS CON ELV STEAM</td> <td>1</td> <td>PZ</td> </tr> </tbody> </table>	Codice	Descrizione	Qtà	UM	0H7323A0	LAMIERA SUPPORTO LAVAGGIO PLUS	1	PZ	0H7820A0	SUPPORTO LAVAGGIO PLUS CON ELV STEAM	1	PZ																																																
Codice	Descrizione	Qtà	UM																																																														
0H7323A0	LAMIERA SUPPORTO LAVAGGIO PLUS	1	PZ																																																														
0H7820A0	SUPPORTO LAVAGGIO PLUS CON ELV STEAM	1	PZ																																																														

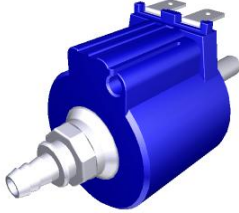
COMPONENTE			RICAMBIO																																																																										
Codice	Descrizione	Immagine	Codice	Descrizione	Lista componenti																																																																								
VL1019A	POMPA VIBRAZIONE		KVL1104A	KIT IMPIANTO LAVAGGIO PLUS 1 GIRANTE USA	<table border="1"> <thead> <tr> <th>Codice</th> <th>Descrizione</th> <th>Qtà</th> <th>UM</th> </tr> </thead> <tbody> <tr> <td>EL1020A1</td> <td>RACCORDO INTERMEDIO "T" TUBO D8 J</td> <td>1</td> <td>PZ</td> </tr> <tr> <td>EL1422A0</td> <td>ELETTROVALV 1 VIA RID.VERDE JG D8-D10 UL</td> <td>1</td> <td>PZ</td> </tr> <tr> <td>EL1422A1</td> <td>ELETTROVALV 1 VIA RID.VERDE JG D8-D10 UL</td> <td>1</td> <td>PZ</td> </tr> <tr> <td>EL1426A0</td> <td>ELETTROVALV 1 OLA UL H2O JG D8-PORTAGO MMA D</td> <td>1</td> <td>PZ</td> </tr> <tr> <td>EL1437A0</td> <td>EV H2O JG D8-PORTAGO MMA D6 CH. VALVE UL</td> <td>1</td> <td>PZ</td> </tr> <tr> <td>GN1526A0</td> <td>O-RING D.INT6.9 SP1.8</td> <td>1</td> <td>PZ</td> </tr> <tr> <td>RC1019A0</td> <td>FASCETTA ELASTICA D10 ZINCATA</td> <td>11</td> <td>PZ</td> </tr> <tr> <td>RC1130A0</td> <td>FASCETTA 130X2,6</td> <td>1</td> <td>PZ</td> </tr> <tr> <td>RC1242A0</td> <td>TERMINALE CHIUSO D10</td> <td>2</td> <td>PZ</td> </tr> <tr> <td>RC1310A0</td> <td>FASCETTA RICHCO 140X4 CON CLIP</td> <td>2</td> <td>PZ</td> </tr> <tr> <td>RC1356A0</td> <td>RACCORDO DRITTO FIL. FEMM 8X1/4 BSP</td> <td>1</td> <td>PZ</td> </tr> <tr> <td>RC1408A0</td> <td>FASCETTA BIFILARE A MOLLA D10.8 TUBO ZN</td> <td>2</td> <td>PZ</td> </tr> <tr> <td>TB1818A0</td> <td>TUBO 8X4.75 PE BLU</td> <td>0.300</td> <td>M</td> </tr> <tr> <td>TB2820A0</td> <td>TUBO EPDM 6X10</td> <td>1.240</td> <td>M</td> </tr> <tr> <td>VI1220A1</td> <td>VITE AUTOFILETTA NTE 4.2X11 TCS+ MARUTE</td> <td>2</td> <td>PZ</td> </tr> <tr> <td>VL1019A0</td> <td>POMPA VIBRAZIONE</td> <td>1</td> <td>PZ</td> </tr> <tr> <td>VL1064A0</td> <td>DISTRIBUTOR E USCITE CIRCUITO LAVAGGIO PL</td> <td>1</td> <td>PZ</td> </tr> </tbody> </table>	Codice	Descrizione	Qtà	UM	EL1020A1	RACCORDO INTERMEDIO "T" TUBO D8 J	1	PZ	EL1422A0	ELETTROVALV 1 VIA RID.VERDE JG D8-D10 UL	1	PZ	EL1422A1	ELETTROVALV 1 VIA RID.VERDE JG D8-D10 UL	1	PZ	EL1426A0	ELETTROVALV 1 OLA UL H2O JG D8-PORTAGO MMA D	1	PZ	EL1437A0	EV H2O JG D8-PORTAGO MMA D6 CH. VALVE UL	1	PZ	GN1526A0	O-RING D.INT6.9 SP1.8	1	PZ	RC1019A0	FASCETTA ELASTICA D10 ZINCATA	11	PZ	RC1130A0	FASCETTA 130X2,6	1	PZ	RC1242A0	TERMINALE CHIUSO D10	2	PZ	RC1310A0	FASCETTA RICHCO 140X4 CON CLIP	2	PZ	RC1356A0	RACCORDO DRITTO FIL. FEMM 8X1/4 BSP	1	PZ	RC1408A0	FASCETTA BIFILARE A MOLLA D10.8 TUBO ZN	2	PZ	TB1818A0	TUBO 8X4.75 PE BLU	0.300	M	TB2820A0	TUBO EPDM 6X10	1.240	M	VI1220A1	VITE AUTOFILETTA NTE 4.2X11 TCS+ MARUTE	2	PZ	VL1019A0	POMPA VIBRAZIONE	1	PZ	VL1064A0	DISTRIBUTOR E USCITE CIRCUITO LAVAGGIO PL	1	PZ
Codice	Descrizione	Qtà	UM																																																																										
EL1020A1	RACCORDO INTERMEDIO "T" TUBO D8 J	1	PZ																																																																										
EL1422A0	ELETTROVALV 1 VIA RID.VERDE JG D8-D10 UL	1	PZ																																																																										
EL1422A1	ELETTROVALV 1 VIA RID.VERDE JG D8-D10 UL	1	PZ																																																																										
EL1426A0	ELETTROVALV 1 OLA UL H2O JG D8-PORTAGO MMA D	1	PZ																																																																										
EL1437A0	EV H2O JG D8-PORTAGO MMA D6 CH. VALVE UL	1	PZ																																																																										
GN1526A0	O-RING D.INT6.9 SP1.8	1	PZ																																																																										
RC1019A0	FASCETTA ELASTICA D10 ZINCATA	11	PZ																																																																										
RC1130A0	FASCETTA 130X2,6	1	PZ																																																																										
RC1242A0	TERMINALE CHIUSO D10	2	PZ																																																																										
RC1310A0	FASCETTA RICHCO 140X4 CON CLIP	2	PZ																																																																										
RC1356A0	RACCORDO DRITTO FIL. FEMM 8X1/4 BSP	1	PZ																																																																										
RC1408A0	FASCETTA BIFILARE A MOLLA D10.8 TUBO ZN	2	PZ																																																																										
TB1818A0	TUBO 8X4.75 PE BLU	0.300	M																																																																										
TB2820A0	TUBO EPDM 6X10	1.240	M																																																																										
VI1220A1	VITE AUTOFILETTA NTE 4.2X11 TCS+ MARUTE	2	PZ																																																																										
VL1019A0	POMPA VIBRAZIONE	1	PZ																																																																										
VL1064A0	DISTRIBUTOR E USCITE CIRCUITO LAVAGGIO PL	1	PZ																																																																										

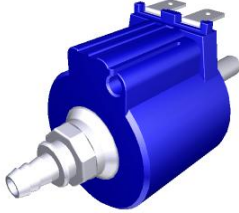
COMPONENTE			RICAMBIO																																										
Codice	Descrizione	Immagine	Codice	Descrizione	Lista componenti																																								
VL1019A	POMPA VIBRAZIONE		KVL1104A	KIT IMPIANTO LAVAGGIO PLUS 1 GIRANTE USA	<table border="1"> <thead> <tr> <th>Codice</th> <th>Descrizione</th> <th>Qtà</th> <th>UM</th> </tr> </thead> <tbody> <tr> <td>VL1065A1</td> <td>PRESSOSTAT O.N.O. 1/4 M CI</td> <td>1</td> <td>PZ</td> </tr> <tr> <td>VL1067A0</td> <td>DISTRIBUTOR E INGRESSI CIRCUITO LAVAGGIO</td> <td>1</td> <td>PZ</td> </tr> <tr> <td>VL1080A0</td> <td>FILTRO IN LINEA DETERGENTE</td> <td>1</td> <td>PZ</td> </tr> <tr> <td>VL1081A0</td> <td>VALVOLA NON RITORNO BARBED D6</td> <td>2</td> <td>PZ</td> </tr> <tr> <td>VL1083A0</td> <td>RACCORDO D10 - PORTAGOMM A BARBED D6</td> <td>1</td> <td>PZ</td> </tr> <tr> <td>VL1102A0</td> <td>FILTRO IN LINEA CON VNR BARBED 6 MM</td> <td>1</td> <td>PZ</td> </tr> <tr> <td>VL1102A1</td> <td>FILTRO IN LINEA DET. + VNR BARBED 6 MM</td> <td>1</td> <td>PZ</td> </tr> <tr> <td>VL1128A0</td> <td>VALVOLA VNR BARBED D6</td> <td>1</td> <td>PZ</td> </tr> <tr> <td>VM2172A0</td> <td>CLIP BLOCCAGGIO POMPA CON CIRCUITO</td> <td>1</td> <td>PZ</td> </tr> </tbody> </table>	Codice	Descrizione	Qtà	UM	VL1065A1	PRESSOSTAT O.N.O. 1/4 M CI	1	PZ	VL1067A0	DISTRIBUTOR E INGRESSI CIRCUITO LAVAGGIO	1	PZ	VL1080A0	FILTRO IN LINEA DETERGENTE	1	PZ	VL1081A0	VALVOLA NON RITORNO BARBED D6	2	PZ	VL1083A0	RACCORDO D10 - PORTAGOMM A BARBED D6	1	PZ	VL1102A0	FILTRO IN LINEA CON VNR BARBED 6 MM	1	PZ	VL1102A1	FILTRO IN LINEA DET. + VNR BARBED 6 MM	1	PZ	VL1128A0	VALVOLA VNR BARBED D6	1	PZ	VM2172A0	CLIP BLOCCAGGIO POMPA CON CIRCUITO	1	PZ
Codice	Descrizione	Qtà	UM																																										
VL1065A1	PRESSOSTAT O.N.O. 1/4 M CI	1	PZ																																										
VL1067A0	DISTRIBUTOR E INGRESSI CIRCUITO LAVAGGIO	1	PZ																																										
VL1080A0	FILTRO IN LINEA DETERGENTE	1	PZ																																										
VL1081A0	VALVOLA NON RITORNO BARBED D6	2	PZ																																										
VL1083A0	RACCORDO D10 - PORTAGOMM A BARBED D6	1	PZ																																										
VL1102A0	FILTRO IN LINEA CON VNR BARBED 6 MM	1	PZ																																										
VL1102A1	FILTRO IN LINEA DET. + VNR BARBED 6 MM	1	PZ																																										
VL1128A0	VALVOLA VNR BARBED D6	1	PZ																																										
VM2172A0	CLIP BLOCCAGGIO POMPA CON CIRCUITO	1	PZ																																										
			KVL1103A	KIT IMPIANTO LAVAGGIO PLUS 2 GIRANTI EUR	<table border="1"> <thead> <tr> <th>Codice</th> <th>Descrizione</th> <th>Qtà</th> <th>UM</th> </tr> </thead> <tbody> <tr> <td>0H7323A0</td> <td>LAMIERA SUPPORTO LAVAGGIO PLUS</td> <td>1</td> <td>PZ</td> </tr> <tr> <td>0H7820A0</td> <td>SUPPORTO LAVAGGIO PLUS CON ELV STEAM</td> <td>1</td> <td>PZ</td> </tr> <tr> <td>EL1252A1</td> <td>ELETTROVALV OLA 1 VIA RID.VERDE JG D8-D10</td> <td>1</td> <td>PZ</td> </tr> <tr> <td>EL1424A0</td> <td>ELETTROVALV OLA H2O JG D8-PORTAGO MMA D6</td> <td>2</td> <td>PZ</td> </tr> <tr> <td>EL1436A0</td> <td>EV H2O JG D8-PORTAGO MMA D6 CHECK VALVE</td> <td>1</td> <td>PZ</td> </tr> <tr> <td>GN1526A0</td> <td>O-RING D.INT6.9 SP1.8</td> <td>1</td> <td>PZ</td> </tr> </tbody> </table>	Codice	Descrizione	Qtà	UM	0H7323A0	LAMIERA SUPPORTO LAVAGGIO PLUS	1	PZ	0H7820A0	SUPPORTO LAVAGGIO PLUS CON ELV STEAM	1	PZ	EL1252A1	ELETTROVALV OLA 1 VIA RID.VERDE JG D8-D10	1	PZ	EL1424A0	ELETTROVALV OLA H2O JG D8-PORTAGO MMA D6	2	PZ	EL1436A0	EV H2O JG D8-PORTAGO MMA D6 CHECK VALVE	1	PZ	GN1526A0	O-RING D.INT6.9 SP1.8	1	PZ												
Codice	Descrizione	Qtà	UM																																										
0H7323A0	LAMIERA SUPPORTO LAVAGGIO PLUS	1	PZ																																										
0H7820A0	SUPPORTO LAVAGGIO PLUS CON ELV STEAM	1	PZ																																										
EL1252A1	ELETTROVALV OLA 1 VIA RID.VERDE JG D8-D10	1	PZ																																										
EL1424A0	ELETTROVALV OLA H2O JG D8-PORTAGO MMA D6	2	PZ																																										
EL1436A0	EV H2O JG D8-PORTAGO MMA D6 CHECK VALVE	1	PZ																																										
GN1526A0	O-RING D.INT6.9 SP1.8	1	PZ																																										

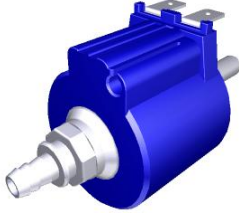
COMPONENTE			RICAMBIO																																																																										
Codice	Descrizione	Immagine	Codice	Descrizione	Lista componenti																																																																								
VL1019A	POMPA VIBRAZIONE		KVL1103A	KIT IMPIANTO LAVAGGIO PLUS 2 GIRANTI EUR	<table border="1"> <thead> <tr> <th>Codice</th> <th>Descrizione</th> <th>Qtà</th> <th>UM</th> </tr> </thead> <tbody> <tr> <td>RC1019A0</td> <td>FASCETTA ELASTICA D10 ZINCATA</td> <td>12</td> <td>PZ</td> </tr> <tr> <td>RC1130A0</td> <td>FASCETTA 130X2,6</td> <td>1</td> <td>PZ</td> </tr> <tr> <td>RC1242A0</td> <td>TERMINALE CHIUSO D10</td> <td>2</td> <td>PZ</td> </tr> <tr> <td>RC1310A0</td> <td>FASCETTA RICHCO 140X4 CON CLIP</td> <td>2</td> <td>PZ</td> </tr> <tr> <td>RC1356A0</td> <td>RACCORDO DRITTO FIL. FEMM 8X1/4 BSP</td> <td>1</td> <td>PZ</td> </tr> <tr> <td>RC1408A0</td> <td>FASCETTA BIFILARE A MOLLA D10.8 TUBO ZN</td> <td>2</td> <td>PZ</td> </tr> <tr> <td>TB1818A0</td> <td>TUBO 8X4.75 PE BLU</td> <td>0.220</td> <td>M</td> </tr> <tr> <td>TB2820A0</td> <td>TUBO EPDM 6X10</td> <td>2.040</td> <td>M</td> </tr> <tr> <td>VI1220A1</td> <td>VITE AUTOFILETTA NTE 4.2X11 TCS+ MARUTE</td> <td>2</td> <td>PZ</td> </tr> <tr> <td>VL1019A0</td> <td>POMPA VIBRAZIONE</td> <td>1</td> <td>PZ</td> </tr> <tr> <td>VL1065A1</td> <td>PRESSOSTAT O.N.O. 1/4 M CI</td> <td>1</td> <td>PZ</td> </tr> <tr> <td>VL1067A0</td> <td>DISTRIBUTOR E INGRESSI CIRCUITO LAVAGGIO</td> <td>1</td> <td>PZ</td> </tr> <tr> <td>VL1080A0</td> <td>FILTRO IN LINEA DETERGENTE</td> <td>1</td> <td>PZ</td> </tr> <tr> <td>VL1081A0</td> <td>VALVOLA NON RITORNO BARBED D6</td> <td>2</td> <td>PZ</td> </tr> <tr> <td>VL1083A0</td> <td>RACCORDO D10 - PORTAGOMM A BARBED D6</td> <td>1</td> <td>PZ</td> </tr> <tr> <td>VL1092A0</td> <td>DISTRIBUTOR E USCITE LAVAGGIO PLUS DOPPIA</td> <td>1</td> <td>PZ</td> </tr> <tr> <td>VL1102A0</td> <td>FILTRO IN LINEA CON VNR BARBED 6 MM</td> <td>1</td> <td>PZ</td> </tr> </tbody> </table>	Codice	Descrizione	Qtà	UM	RC1019A0	FASCETTA ELASTICA D10 ZINCATA	12	PZ	RC1130A0	FASCETTA 130X2,6	1	PZ	RC1242A0	TERMINALE CHIUSO D10	2	PZ	RC1310A0	FASCETTA RICHCO 140X4 CON CLIP	2	PZ	RC1356A0	RACCORDO DRITTO FIL. FEMM 8X1/4 BSP	1	PZ	RC1408A0	FASCETTA BIFILARE A MOLLA D10.8 TUBO ZN	2	PZ	TB1818A0	TUBO 8X4.75 PE BLU	0.220	M	TB2820A0	TUBO EPDM 6X10	2.040	M	VI1220A1	VITE AUTOFILETTA NTE 4.2X11 TCS+ MARUTE	2	PZ	VL1019A0	POMPA VIBRAZIONE	1	PZ	VL1065A1	PRESSOSTAT O.N.O. 1/4 M CI	1	PZ	VL1067A0	DISTRIBUTOR E INGRESSI CIRCUITO LAVAGGIO	1	PZ	VL1080A0	FILTRO IN LINEA DETERGENTE	1	PZ	VL1081A0	VALVOLA NON RITORNO BARBED D6	2	PZ	VL1083A0	RACCORDO D10 - PORTAGOMM A BARBED D6	1	PZ	VL1092A0	DISTRIBUTOR E USCITE LAVAGGIO PLUS DOPPIA	1	PZ	VL1102A0	FILTRO IN LINEA CON VNR BARBED 6 MM	1	PZ
Codice	Descrizione	Qtà	UM																																																																										
RC1019A0	FASCETTA ELASTICA D10 ZINCATA	12	PZ																																																																										
RC1130A0	FASCETTA 130X2,6	1	PZ																																																																										
RC1242A0	TERMINALE CHIUSO D10	2	PZ																																																																										
RC1310A0	FASCETTA RICHCO 140X4 CON CLIP	2	PZ																																																																										
RC1356A0	RACCORDO DRITTO FIL. FEMM 8X1/4 BSP	1	PZ																																																																										
RC1408A0	FASCETTA BIFILARE A MOLLA D10.8 TUBO ZN	2	PZ																																																																										
TB1818A0	TUBO 8X4.75 PE BLU	0.220	M																																																																										
TB2820A0	TUBO EPDM 6X10	2.040	M																																																																										
VI1220A1	VITE AUTOFILETTA NTE 4.2X11 TCS+ MARUTE	2	PZ																																																																										
VL1019A0	POMPA VIBRAZIONE	1	PZ																																																																										
VL1065A1	PRESSOSTAT O.N.O. 1/4 M CI	1	PZ																																																																										
VL1067A0	DISTRIBUTOR E INGRESSI CIRCUITO LAVAGGIO	1	PZ																																																																										
VL1080A0	FILTRO IN LINEA DETERGENTE	1	PZ																																																																										
VL1081A0	VALVOLA NON RITORNO BARBED D6	2	PZ																																																																										
VL1083A0	RACCORDO D10 - PORTAGOMM A BARBED D6	1	PZ																																																																										
VL1092A0	DISTRIBUTOR E USCITE LAVAGGIO PLUS DOPPIA	1	PZ																																																																										
VL1102A0	FILTRO IN LINEA CON VNR BARBED 6 MM	1	PZ																																																																										

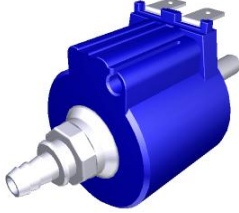
COMPONENTE			RICAMBIO																																																														
Codice	Descrizione	Immagine	Codice	Descrizione	Lista componenti																																																												
VL1019A	POMPA VIBRAZIONE		KVL1103A	KIT IMPIANTO LAVAGGIO PLUS 2 GIRANTI EUR	<table border="1"> <thead> <tr> <th>Codice</th> <th>Descrizione</th> <th>Qtà</th> <th>UM</th> </tr> </thead> <tbody> <tr> <td>VL1102A1</td> <td>FILTRO IN LINEA DET. + VNR BARBED 6 MM</td> <td>1</td> <td>PZ</td> </tr> <tr> <td>VL1128A0</td> <td>VALVOLA VNR BARBED D6</td> <td>1</td> <td>PZ</td> </tr> <tr> <td>VM2172A0</td> <td>CLIP BLOCCAGGIO POMPA CON CIRCUITO</td> <td>1</td> <td>PZ</td> </tr> </tbody> </table>	Codice	Descrizione	Qtà	UM	VL1102A1	FILTRO IN LINEA DET. + VNR BARBED 6 MM	1	PZ	VL1128A0	VALVOLA VNR BARBED D6	1	PZ	VM2172A0	CLIP BLOCCAGGIO POMPA CON CIRCUITO	1	PZ																																												
Codice	Descrizione	Qtà	UM																																																														
VL1102A1	FILTRO IN LINEA DET. + VNR BARBED 6 MM	1	PZ																																																														
VL1128A0	VALVOLA VNR BARBED D6	1	PZ																																																														
VM2172A0	CLIP BLOCCAGGIO POMPA CON CIRCUITO	1	PZ																																																														
			KVL1101A	KIT IMPIANTO LAVAGGIO PLUS 1 GIRANTE EUR	<table border="1"> <thead> <tr> <th>Codice</th> <th>Descrizione</th> <th>Qtà</th> <th>UM</th> </tr> </thead> <tbody> <tr> <td>0H7323A0</td> <td>LAMIERA SUPPORTO LAVAGGIO PLUS</td> <td>1</td> <td>PZ</td> </tr> <tr> <td>0H7820A0</td> <td>SUPPORTO LAVAGGIO PLUS CON ELV STEAM</td> <td>1</td> <td>PZ</td> </tr> <tr> <td>EL1252A1</td> <td>ELETTROVALV OLA 1 VIA RID.VERDE JG D8-D10</td> <td>1</td> <td>PZ</td> </tr> <tr> <td>EL1424A0</td> <td>ELETTROVALV OLA H2O JG D8-PORTAGO MMA D6</td> <td>1</td> <td>PZ</td> </tr> <tr> <td>EL1436A0</td> <td>EV H2O JG D8-PORTAGO MMA D6 CHECK VALVE</td> <td>1</td> <td>PZ</td> </tr> <tr> <td>GN1526A0</td> <td>O-RING D.INT6.9 SP1.8</td> <td>1</td> <td>PZ</td> </tr> <tr> <td>RC1019A0</td> <td>FASCETTA ELASTICA D10 ZINCATA</td> <td>11</td> <td>PZ</td> </tr> <tr> <td>RC1130A0</td> <td>FASCETTA 130X2,6</td> <td>1</td> <td>PZ</td> </tr> <tr> <td>RC1242A0</td> <td>TERMINALE CHIUSO D10</td> <td>2</td> <td>PZ</td> </tr> <tr> <td>RC1310A0</td> <td>FASCETTA RICHCO 140X4 CON CLIP</td> <td>2</td> <td>PZ</td> </tr> <tr> <td>RC1356A0</td> <td>RACCORDO DRITTO FIL. FEMM 8X1/4 BSP</td> <td>1</td> <td>PZ</td> </tr> <tr> <td>RC1408A0</td> <td>FASCETTA BIFILARE A MOLLA D10.8 TUBO ZN</td> <td>6</td> <td>PZ</td> </tr> <tr> <td>TB1818A0</td> <td>TUBO 8X4.75 PE BLU</td> <td>0.220</td> <td>M</td> </tr> <tr> <td>TB2820A0</td> <td>TUBO EPDM 6X10</td> <td>1.240</td> <td>M</td> </tr> </tbody> </table>	Codice	Descrizione	Qtà	UM	0H7323A0	LAMIERA SUPPORTO LAVAGGIO PLUS	1	PZ	0H7820A0	SUPPORTO LAVAGGIO PLUS CON ELV STEAM	1	PZ	EL1252A1	ELETTROVALV OLA 1 VIA RID.VERDE JG D8-D10	1	PZ	EL1424A0	ELETTROVALV OLA H2O JG D8-PORTAGO MMA D6	1	PZ	EL1436A0	EV H2O JG D8-PORTAGO MMA D6 CHECK VALVE	1	PZ	GN1526A0	O-RING D.INT6.9 SP1.8	1	PZ	RC1019A0	FASCETTA ELASTICA D10 ZINCATA	11	PZ	RC1130A0	FASCETTA 130X2,6	1	PZ	RC1242A0	TERMINALE CHIUSO D10	2	PZ	RC1310A0	FASCETTA RICHCO 140X4 CON CLIP	2	PZ	RC1356A0	RACCORDO DRITTO FIL. FEMM 8X1/4 BSP	1	PZ	RC1408A0	FASCETTA BIFILARE A MOLLA D10.8 TUBO ZN	6	PZ	TB1818A0	TUBO 8X4.75 PE BLU	0.220	M	TB2820A0	TUBO EPDM 6X10	1.240	M
Codice	Descrizione	Qtà	UM																																																														
0H7323A0	LAMIERA SUPPORTO LAVAGGIO PLUS	1	PZ																																																														
0H7820A0	SUPPORTO LAVAGGIO PLUS CON ELV STEAM	1	PZ																																																														
EL1252A1	ELETTROVALV OLA 1 VIA RID.VERDE JG D8-D10	1	PZ																																																														
EL1424A0	ELETTROVALV OLA H2O JG D8-PORTAGO MMA D6	1	PZ																																																														
EL1436A0	EV H2O JG D8-PORTAGO MMA D6 CHECK VALVE	1	PZ																																																														
GN1526A0	O-RING D.INT6.9 SP1.8	1	PZ																																																														
RC1019A0	FASCETTA ELASTICA D10 ZINCATA	11	PZ																																																														
RC1130A0	FASCETTA 130X2,6	1	PZ																																																														
RC1242A0	TERMINALE CHIUSO D10	2	PZ																																																														
RC1310A0	FASCETTA RICHCO 140X4 CON CLIP	2	PZ																																																														
RC1356A0	RACCORDO DRITTO FIL. FEMM 8X1/4 BSP	1	PZ																																																														
RC1408A0	FASCETTA BIFILARE A MOLLA D10.8 TUBO ZN	6	PZ																																																														
TB1818A0	TUBO 8X4.75 PE BLU	0.220	M																																																														
TB2820A0	TUBO EPDM 6X10	1.240	M																																																														

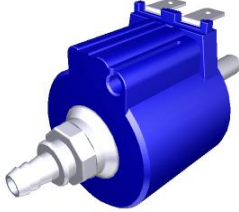

COMPONENTE			RICAMBIO																																																						
Codice	Descrizione	Immagine	Codice	Descrizione	Lista componenti																																																				
VL1019A	POMPA VIBRAZIONE		KVL1101A	KIT IMPIANTO LAVAGGIO PLUS 1 GIRANTE EUR	<table border="1"> <thead> <tr> <th>Codice</th> <th>Descrizione</th> <th>Qtà</th> <th>UM</th> </tr> </thead> <tbody> <tr> <td>VI1220A1</td> <td>VITE AUTOFILETTA NTE 4.2X11 TCS+ MARUTE</td> <td>2</td> <td>PZ</td> </tr> <tr> <td>VL1019A0</td> <td>POMPA VIBRAZIONE</td> <td>1</td> <td>PZ</td> </tr> <tr> <td>VL1064A0</td> <td>DISTRIBUTOR E USCITE CIRCUITO LAVAGGIO PL</td> <td>1</td> <td>PZ</td> </tr> <tr> <td>VL1065A1</td> <td>PRESSOSTAT O.N.O. 1/4 M CI</td> <td>1</td> <td>PZ</td> </tr> <tr> <td>VL1067A0</td> <td>DISTRIBUTOR E INGRESSI CIRCUITO LAVAGGIO</td> <td>1</td> <td>PZ</td> </tr> <tr> <td>VL1080A0</td> <td>FILTRO IN LINEA DETERGENTE</td> <td>1</td> <td>PZ</td> </tr> <tr> <td>VL1081A0</td> <td>VALVOLA NON RITORNO BARBED D6</td> <td>2</td> <td>PZ</td> </tr> <tr> <td>VL1083A0</td> <td>RACCORDO D10 - PORTAGOMM A BARBED D6</td> <td>1</td> <td>PZ</td> </tr> <tr> <td>VL1102A0</td> <td>FILTRO IN LINEA CON VNR BARBED 6 MM</td> <td>1</td> <td>PZ</td> </tr> <tr> <td>VL1102A1</td> <td>FILTRO IN LINEA DET. + VNR BARBED 6 MM</td> <td>1</td> <td>PZ</td> </tr> <tr> <td>VL1128A0</td> <td>VALVOLA VNR BARBED D6</td> <td>1</td> <td>PZ</td> </tr> <tr> <td>VM2172A0</td> <td>CLIP BLOCCAGGIO POMPA CON CIRCUITO</td> <td>1</td> <td>PZ</td> </tr> </tbody> </table>	Codice	Descrizione	Qtà	UM	VI1220A1	VITE AUTOFILETTA NTE 4.2X11 TCS+ MARUTE	2	PZ	VL1019A0	POMPA VIBRAZIONE	1	PZ	VL1064A0	DISTRIBUTOR E USCITE CIRCUITO LAVAGGIO PL	1	PZ	VL1065A1	PRESSOSTAT O.N.O. 1/4 M CI	1	PZ	VL1067A0	DISTRIBUTOR E INGRESSI CIRCUITO LAVAGGIO	1	PZ	VL1080A0	FILTRO IN LINEA DETERGENTE	1	PZ	VL1081A0	VALVOLA NON RITORNO BARBED D6	2	PZ	VL1083A0	RACCORDO D10 - PORTAGOMM A BARBED D6	1	PZ	VL1102A0	FILTRO IN LINEA CON VNR BARBED 6 MM	1	PZ	VL1102A1	FILTRO IN LINEA DET. + VNR BARBED 6 MM	1	PZ	VL1128A0	VALVOLA VNR BARBED D6	1	PZ	VM2172A0	CLIP BLOCCAGGIO POMPA CON CIRCUITO	1	PZ
Codice	Descrizione	Qtà	UM																																																						
VI1220A1	VITE AUTOFILETTA NTE 4.2X11 TCS+ MARUTE	2	PZ																																																						
VL1019A0	POMPA VIBRAZIONE	1	PZ																																																						
VL1064A0	DISTRIBUTOR E USCITE CIRCUITO LAVAGGIO PL	1	PZ																																																						
VL1065A1	PRESSOSTAT O.N.O. 1/4 M CI	1	PZ																																																						
VL1067A0	DISTRIBUTOR E INGRESSI CIRCUITO LAVAGGIO	1	PZ																																																						
VL1080A0	FILTRO IN LINEA DETERGENTE	1	PZ																																																						
VL1081A0	VALVOLA NON RITORNO BARBED D6	2	PZ																																																						
VL1083A0	RACCORDO D10 - PORTAGOMM A BARBED D6	1	PZ																																																						
VL1102A0	FILTRO IN LINEA CON VNR BARBED 6 MM	1	PZ																																																						
VL1102A1	FILTRO IN LINEA DET. + VNR BARBED 6 MM	1	PZ																																																						
VL1128A0	VALVOLA VNR BARBED D6	1	PZ																																																						
VM2172A0	CLIP BLOCCAGGIO POMPA CON CIRCUITO	1	PZ																																																						
			KVL1094A	KIT IMPIANTO LAVAGGIO 0311 EU	<table border="1"> <thead> <tr> <th>Codice</th> <th>Descrizione</th> <th>Qtà</th> <th>UM</th> </tr> </thead> <tbody> <tr> <td>0H7494A0</td> <td>LAMIERA SUPPORTO LAVAGGIO ONE-03</td> <td>1</td> <td>PZ</td> </tr> <tr> <td>0H7494B0</td> <td>LAMIERA SUPPORTO LAVAGGIO ONE-03</td> <td>1</td> <td>PZ</td> </tr> <tr> <td>EL1436A0</td> <td>EV H2O JG D8-PORTAGO MMA D6 CHECK VALVE</td> <td>1</td> <td>PZ</td> </tr> </tbody> </table>	Codice	Descrizione	Qtà	UM	0H7494A0	LAMIERA SUPPORTO LAVAGGIO ONE-03	1	PZ	0H7494B0	LAMIERA SUPPORTO LAVAGGIO ONE-03	1	PZ	EL1436A0	EV H2O JG D8-PORTAGO MMA D6 CHECK VALVE	1	PZ																																				
Codice	Descrizione	Qtà	UM																																																						
0H7494A0	LAMIERA SUPPORTO LAVAGGIO ONE-03	1	PZ																																																						
0H7494B0	LAMIERA SUPPORTO LAVAGGIO ONE-03	1	PZ																																																						
EL1436A0	EV H2O JG D8-PORTAGO MMA D6 CHECK VALVE	1	PZ																																																						

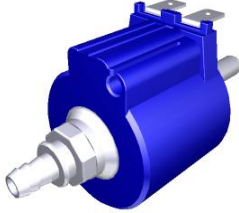

COMPONENTE			RICAMBIO																																																																										
Codice	Descrizione	Immagine	Codice	Descrizione	Lista componenti																																																																								
VL1019A	POMPA VIBRAZIONE		KVL1094A	KIT IMPIANTO LAVAGGIO 0311 EU	<table border="1"> <thead> <tr> <th>Codice</th> <th>Descrizione</th> <th>Qtà</th> <th>UM</th> </tr> </thead> <tbody> <tr> <td>GN1526A0</td> <td>O-RING D.INT6.9 SP1.8</td> <td>1</td> <td>PZ</td> </tr> <tr> <td>RC1006A0</td> <td>CURVA GUIDA TUBO PET D8</td> <td>2</td> <td>PZ</td> </tr> <tr> <td>RC1019A0</td> <td>FASCETTA ELASTICA D10 ZINCATA</td> <td>15</td> <td>PZ</td> </tr> <tr> <td>RC1242A0</td> <td>TERMINALE CHIUSO D10</td> <td>2</td> <td>PZ</td> </tr> <tr> <td>RC1408A0</td> <td>FASCETTA BIFILARE A MOLLA D10.8 TUBO ZN</td> <td>4</td> <td>PZ</td> </tr> <tr> <td>TB1818A0</td> <td>TUBO 8X4.75 PE BLU</td> <td>0.320</td> <td>M</td> </tr> <tr> <td>TB2820A0</td> <td>TUBO EPDM 6X10</td> <td>1.030</td> <td>M</td> </tr> <tr> <td>VI1220A1</td> <td>VITE AUTOFILETTA NTE 4.2X11 TCS+ MARUTE</td> <td>1</td> <td>PZ</td> </tr> <tr> <td>VL1019A0</td> <td>POMPA VIBRAZIONE</td> <td>1</td> <td>PZ</td> </tr> <tr> <td>VL1053B0</td> <td>DISTRIBUTORE E USCITA LAVAGGIO ON</td> <td>1</td> <td>PZ</td> </tr> <tr> <td>VL1054B0</td> <td>DISTRIBUTORE E INGRESSI LAVAGGIO ON</td> <td>1</td> <td>PZ</td> </tr> <tr> <td>VL1080A0</td> <td>FILTRO IN LINEA DETERGENTE</td> <td>1</td> <td>PZ</td> </tr> <tr> <td>VL1081A0</td> <td>VALVOLA NON RITORNO BARBED D6</td> <td>1</td> <td>PZ</td> </tr> <tr> <td>VL1102A0</td> <td>FILTRO IN LINEA CON VNR BARBED 6 MM</td> <td>1</td> <td>PZ</td> </tr> <tr> <td>VL1102A1</td> <td>FILTRO IN LINEA DET. + VNR BARBED 6 MM</td> <td>1</td> <td>PZ</td> </tr> <tr> <td>VL1128A0</td> <td>VALVOLA VNR BARBED D6</td> <td>1</td> <td>PZ</td> </tr> <tr> <td>VM2172A0</td> <td>CLIP BLOCCAGGIO POMPA CON CIRCUITO</td> <td>1</td> <td>PZ</td> </tr> </tbody> </table>	Codice	Descrizione	Qtà	UM	GN1526A0	O-RING D.INT6.9 SP1.8	1	PZ	RC1006A0	CURVA GUIDA TUBO PET D8	2	PZ	RC1019A0	FASCETTA ELASTICA D10 ZINCATA	15	PZ	RC1242A0	TERMINALE CHIUSO D10	2	PZ	RC1408A0	FASCETTA BIFILARE A MOLLA D10.8 TUBO ZN	4	PZ	TB1818A0	TUBO 8X4.75 PE BLU	0.320	M	TB2820A0	TUBO EPDM 6X10	1.030	M	VI1220A1	VITE AUTOFILETTA NTE 4.2X11 TCS+ MARUTE	1	PZ	VL1019A0	POMPA VIBRAZIONE	1	PZ	VL1053B0	DISTRIBUTORE E USCITA LAVAGGIO ON	1	PZ	VL1054B0	DISTRIBUTORE E INGRESSI LAVAGGIO ON	1	PZ	VL1080A0	FILTRO IN LINEA DETERGENTE	1	PZ	VL1081A0	VALVOLA NON RITORNO BARBED D6	1	PZ	VL1102A0	FILTRO IN LINEA CON VNR BARBED 6 MM	1	PZ	VL1102A1	FILTRO IN LINEA DET. + VNR BARBED 6 MM	1	PZ	VL1128A0	VALVOLA VNR BARBED D6	1	PZ	VM2172A0	CLIP BLOCCAGGIO POMPA CON CIRCUITO	1	PZ
Codice	Descrizione	Qtà	UM																																																																										
GN1526A0	O-RING D.INT6.9 SP1.8	1	PZ																																																																										
RC1006A0	CURVA GUIDA TUBO PET D8	2	PZ																																																																										
RC1019A0	FASCETTA ELASTICA D10 ZINCATA	15	PZ																																																																										
RC1242A0	TERMINALE CHIUSO D10	2	PZ																																																																										
RC1408A0	FASCETTA BIFILARE A MOLLA D10.8 TUBO ZN	4	PZ																																																																										
TB1818A0	TUBO 8X4.75 PE BLU	0.320	M																																																																										
TB2820A0	TUBO EPDM 6X10	1.030	M																																																																										
VI1220A1	VITE AUTOFILETTA NTE 4.2X11 TCS+ MARUTE	1	PZ																																																																										
VL1019A0	POMPA VIBRAZIONE	1	PZ																																																																										
VL1053B0	DISTRIBUTORE E USCITA LAVAGGIO ON	1	PZ																																																																										
VL1054B0	DISTRIBUTORE E INGRESSI LAVAGGIO ON	1	PZ																																																																										
VL1080A0	FILTRO IN LINEA DETERGENTE	1	PZ																																																																										
VL1081A0	VALVOLA NON RITORNO BARBED D6	1	PZ																																																																										
VL1102A0	FILTRO IN LINEA CON VNR BARBED 6 MM	1	PZ																																																																										
VL1102A1	FILTRO IN LINEA DET. + VNR BARBED 6 MM	1	PZ																																																																										
VL1128A0	VALVOLA VNR BARBED D6	1	PZ																																																																										
VM2172A0	CLIP BLOCCAGGIO POMPA CON CIRCUITO	1	PZ																																																																										

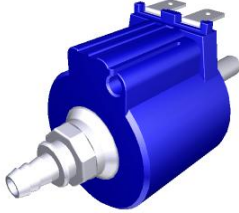

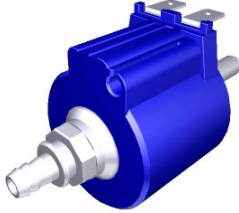
COMPONENTE			RICAMBIO																																																										
Codice	Descrizione	Immagine	Codice	Descrizione	Lista componenti																																																								
VL1019A	POMPA VIBRAZIONE		KVL1092A	KIT POMPA IMPIANTO LAVAGGIO PLUS 2GIR EU	<table border="1"> <thead> <tr> <th>Codice</th> <th>Descrizione</th> <th>Qtà</th> <th>UM</th> </tr> </thead> <tbody> <tr> <td>GN1526A0</td> <td>O-RING D.INT6.9 SP1.8</td> <td>1</td> <td>PZ</td> </tr> <tr> <td>RC1019A0</td> <td>FASCETTA ELASTICA D10 ZINCATA</td> <td>4</td> <td>PZ</td> </tr> <tr> <td>RC1130A0</td> <td>FASCETTA 130X2,6</td> <td>1</td> <td>PZ</td> </tr> <tr> <td>RC1242A0</td> <td>TERMINALE CHIUSO D10</td> <td>2</td> <td>PZ</td> </tr> <tr> <td>RC1408A0</td> <td>FASCETTA BIFILARE A MOLLA D10.8 TUBO ZN</td> <td>4</td> <td>PZ</td> </tr> <tr> <td>TB2820A0</td> <td>TUBO EPDM 6X10</td> <td>0.120</td> <td>M</td> </tr> <tr> <td>VI1220A1</td> <td>VITE AUTOFILETTA NTE 4.2X11 TCS+ MARUTE</td> <td>2</td> <td>PZ</td> </tr> <tr> <td>VL1019A0</td> <td>POMPA VIBRAZIONE</td> <td>1</td> <td>PZ</td> </tr> <tr> <td>VL1067A0</td> <td>DISTRIBUTOR E INGRESSI CIRCUITO LAVAGGIO</td> <td>1</td> <td>PZ</td> </tr> <tr> <td>VL1081A0</td> <td>VALVOLA NON RITORNO BARBED D6</td> <td>1</td> <td>PZ</td> </tr> <tr> <td>VL1092A0</td> <td>DISTRIBUTOR E USCITE LAVAGGIO PLUS DOPPIA</td> <td>1</td> <td>PZ</td> </tr> <tr> <td>VL1128A0</td> <td>VALVOLA VNR BARBED D6</td> <td>1</td> <td>PZ</td> </tr> <tr> <td>VM2172A0</td> <td>CLIP BLOCCAGGIO POMPA CON CIRCUITO</td> <td>1</td> <td>PZ</td> </tr> </tbody> </table>	Codice	Descrizione	Qtà	UM	GN1526A0	O-RING D.INT6.9 SP1.8	1	PZ	RC1019A0	FASCETTA ELASTICA D10 ZINCATA	4	PZ	RC1130A0	FASCETTA 130X2,6	1	PZ	RC1242A0	TERMINALE CHIUSO D10	2	PZ	RC1408A0	FASCETTA BIFILARE A MOLLA D10.8 TUBO ZN	4	PZ	TB2820A0	TUBO EPDM 6X10	0.120	M	VI1220A1	VITE AUTOFILETTA NTE 4.2X11 TCS+ MARUTE	2	PZ	VL1019A0	POMPA VIBRAZIONE	1	PZ	VL1067A0	DISTRIBUTOR E INGRESSI CIRCUITO LAVAGGIO	1	PZ	VL1081A0	VALVOLA NON RITORNO BARBED D6	1	PZ	VL1092A0	DISTRIBUTOR E USCITE LAVAGGIO PLUS DOPPIA	1	PZ	VL1128A0	VALVOLA VNR BARBED D6	1	PZ	VM2172A0	CLIP BLOCCAGGIO POMPA CON CIRCUITO	1	PZ
Codice	Descrizione	Qtà	UM																																																										
GN1526A0	O-RING D.INT6.9 SP1.8	1	PZ																																																										
RC1019A0	FASCETTA ELASTICA D10 ZINCATA	4	PZ																																																										
RC1130A0	FASCETTA 130X2,6	1	PZ																																																										
RC1242A0	TERMINALE CHIUSO D10	2	PZ																																																										
RC1408A0	FASCETTA BIFILARE A MOLLA D10.8 TUBO ZN	4	PZ																																																										
TB2820A0	TUBO EPDM 6X10	0.120	M																																																										
VI1220A1	VITE AUTOFILETTA NTE 4.2X11 TCS+ MARUTE	2	PZ																																																										
VL1019A0	POMPA VIBRAZIONE	1	PZ																																																										
VL1067A0	DISTRIBUTOR E INGRESSI CIRCUITO LAVAGGIO	1	PZ																																																										
VL1081A0	VALVOLA NON RITORNO BARBED D6	1	PZ																																																										
VL1092A0	DISTRIBUTOR E USCITE LAVAGGIO PLUS DOPPIA	1	PZ																																																										
VL1128A0	VALVOLA VNR BARBED D6	1	PZ																																																										
VM2172A0	CLIP BLOCCAGGIO POMPA CON CIRCUITO	1	PZ																																																										
			KVL1073A	KIT POMPA IMPIANTO LAVAGGIO PLUS 1GIR EU	<table border="1"> <thead> <tr> <th>Codice</th> <th>Descrizione</th> <th>Qtà</th> <th>UM</th> </tr> </thead> <tbody> <tr> <td>GN1526A0</td> <td>O-RING D.INT6.9 SP1.8</td> <td>1</td> <td>PZ</td> </tr> <tr> <td>RC1019A0</td> <td>FASCETTA ELASTICA D10 ZINCATA</td> <td>4</td> <td>PZ</td> </tr> <tr> <td>RC1130A0</td> <td>FASCETTA 130X2,6</td> <td>1</td> <td>PZ</td> </tr> <tr> <td>RC1242A0</td> <td>TERMINALE CHIUSO D10</td> <td>2</td> <td>PZ</td> </tr> <tr> <td>RC1408A0</td> <td>FASCETTA BIFILARE A MOLLA D10.8 TUBO ZN</td> <td>2</td> <td>PZ</td> </tr> <tr> <td>TB2820A0</td> <td>TUBO EPDM 6X10</td> <td>0.120</td> <td>M</td> </tr> </tbody> </table>	Codice	Descrizione	Qtà	UM	GN1526A0	O-RING D.INT6.9 SP1.8	1	PZ	RC1019A0	FASCETTA ELASTICA D10 ZINCATA	4	PZ	RC1130A0	FASCETTA 130X2,6	1	PZ	RC1242A0	TERMINALE CHIUSO D10	2	PZ	RC1408A0	FASCETTA BIFILARE A MOLLA D10.8 TUBO ZN	2	PZ	TB2820A0	TUBO EPDM 6X10	0.120	M																												
Codice	Descrizione	Qtà	UM																																																										
GN1526A0	O-RING D.INT6.9 SP1.8	1	PZ																																																										
RC1019A0	FASCETTA ELASTICA D10 ZINCATA	4	PZ																																																										
RC1130A0	FASCETTA 130X2,6	1	PZ																																																										
RC1242A0	TERMINALE CHIUSO D10	2	PZ																																																										
RC1408A0	FASCETTA BIFILARE A MOLLA D10.8 TUBO ZN	2	PZ																																																										
TB2820A0	TUBO EPDM 6X10	0.120	M																																																										

COMPONENTE			RICAMBIO																																																						
Codice	Descrizione	Immagine	Codice	Descrizione	Lista componenti																																																				
VL1019A	POMPA VIBRAZIONE		KVL1073A	KIT POMPA IMPIANTO LAVAGGIO PLUS 1GIR EU	<table border="1"> <thead> <tr> <th>Codice</th> <th>Descrizione</th> <th>Qtà</th> <th>UM</th> </tr> </thead> <tbody> <tr> <td>VL1019A0</td> <td>POMPA VIBRAZIONE</td> <td>1</td> <td>PZ</td> </tr> <tr> <td>VL1064A0</td> <td>DISTRIBUTOR E USCITE CIRCUITO LAVAGGIO PL</td> <td>1</td> <td>PZ</td> </tr> <tr> <td>VL1067A0</td> <td>DISTRIBUTOR E INGRESSI CIRCUITO LAVAGGIO</td> <td>1</td> <td>PZ</td> </tr> <tr> <td>VL1081A0</td> <td>VALVOLA NON RITORNO BARBED D6</td> <td>1</td> <td>PZ</td> </tr> <tr> <td>VL1128A0</td> <td>VALVOLA VNR BARBED D6</td> <td>1</td> <td>PZ</td> </tr> <tr> <td>VM2172A0</td> <td>CLIP BLOCCAGGIO POMPA CON CIRCUITO</td> <td>1</td> <td>PZ</td> </tr> </tbody> </table>	Codice	Descrizione	Qtà	UM	VL1019A0	POMPA VIBRAZIONE	1	PZ	VL1064A0	DISTRIBUTOR E USCITE CIRCUITO LAVAGGIO PL	1	PZ	VL1067A0	DISTRIBUTOR E INGRESSI CIRCUITO LAVAGGIO	1	PZ	VL1081A0	VALVOLA NON RITORNO BARBED D6	1	PZ	VL1128A0	VALVOLA VNR BARBED D6	1	PZ	VM2172A0	CLIP BLOCCAGGIO POMPA CON CIRCUITO	1	PZ																								
Codice	Descrizione	Qtà	UM																																																						
VL1019A0	POMPA VIBRAZIONE	1	PZ																																																						
VL1064A0	DISTRIBUTOR E USCITE CIRCUITO LAVAGGIO PL	1	PZ																																																						
VL1067A0	DISTRIBUTOR E INGRESSI CIRCUITO LAVAGGIO	1	PZ																																																						
VL1081A0	VALVOLA NON RITORNO BARBED D6	1	PZ																																																						
VL1128A0	VALVOLA VNR BARBED D6	1	PZ																																																						
VM2172A0	CLIP BLOCCAGGIO POMPA CON CIRCUITO	1	PZ																																																						
			KVL1072A	KIT POMPA IMPIANTO LAVAGGIO ONE	<table border="1"> <thead> <tr> <th>Codice</th> <th>Descrizione</th> <th>Qtà</th> <th>UM</th> </tr> </thead> <tbody> <tr> <td>GN1526A0</td> <td>O-RING D.INT6.9 SP1.8</td> <td>1</td> <td>PZ</td> </tr> <tr> <td>RC1019A0</td> <td>FASCETTA ELASTICA D10 ZINCATA</td> <td>3</td> <td>PZ</td> </tr> <tr> <td>RC1242A0</td> <td>TERMINALE CHIUSO D10</td> <td>2</td> <td>PZ</td> </tr> <tr> <td>RC1408A0</td> <td>FASCETTA BIFILARE A MOLLA D10.8 TUBO ZN</td> <td>2</td> <td>PZ</td> </tr> <tr> <td>TB2820A0</td> <td>TUBO EPDM 6X10</td> <td>0.120</td> <td>M</td> </tr> <tr> <td>VI1220A1</td> <td>VITE AUTOFILETTA NTE 4.2X11 TCS+ MARUTE</td> <td>1</td> <td>PZ</td> </tr> <tr> <td>VL1019A0</td> <td>POMPA VIBRAZIONE</td> <td>1</td> <td>PZ</td> </tr> <tr> <td>VL1053B0</td> <td>DISTRIBUTOR E USCITA LAVAGGIO ON</td> <td>1</td> <td>PZ</td> </tr> <tr> <td>VL1054B0</td> <td>DISTRIBUTOR E INGRESSI LAVAGGIO ON</td> <td>1</td> <td>PZ</td> </tr> <tr> <td>VL1081A0</td> <td>VALVOLA NON RITORNO BARBED D6</td> <td>2</td> <td>PZ</td> </tr> <tr> <td>VL1128A0</td> <td>VALVOLA VNR BARBED D6</td> <td>1</td> <td>PZ</td> </tr> <tr> <td>VM2172A0</td> <td>CLIP BLOCCAGGIO POMPA CON CIRCUITO</td> <td>1</td> <td>PZ</td> </tr> </tbody> </table>	Codice	Descrizione	Qtà	UM	GN1526A0	O-RING D.INT6.9 SP1.8	1	PZ	RC1019A0	FASCETTA ELASTICA D10 ZINCATA	3	PZ	RC1242A0	TERMINALE CHIUSO D10	2	PZ	RC1408A0	FASCETTA BIFILARE A MOLLA D10.8 TUBO ZN	2	PZ	TB2820A0	TUBO EPDM 6X10	0.120	M	VI1220A1	VITE AUTOFILETTA NTE 4.2X11 TCS+ MARUTE	1	PZ	VL1019A0	POMPA VIBRAZIONE	1	PZ	VL1053B0	DISTRIBUTOR E USCITA LAVAGGIO ON	1	PZ	VL1054B0	DISTRIBUTOR E INGRESSI LAVAGGIO ON	1	PZ	VL1081A0	VALVOLA NON RITORNO BARBED D6	2	PZ	VL1128A0	VALVOLA VNR BARBED D6	1	PZ	VM2172A0	CLIP BLOCCAGGIO POMPA CON CIRCUITO	1	PZ
Codice	Descrizione	Qtà	UM																																																						
GN1526A0	O-RING D.INT6.9 SP1.8	1	PZ																																																						
RC1019A0	FASCETTA ELASTICA D10 ZINCATA	3	PZ																																																						
RC1242A0	TERMINALE CHIUSO D10	2	PZ																																																						
RC1408A0	FASCETTA BIFILARE A MOLLA D10.8 TUBO ZN	2	PZ																																																						
TB2820A0	TUBO EPDM 6X10	0.120	M																																																						
VI1220A1	VITE AUTOFILETTA NTE 4.2X11 TCS+ MARUTE	1	PZ																																																						
VL1019A0	POMPA VIBRAZIONE	1	PZ																																																						
VL1053B0	DISTRIBUTOR E USCITA LAVAGGIO ON	1	PZ																																																						
VL1054B0	DISTRIBUTOR E INGRESSI LAVAGGIO ON	1	PZ																																																						
VL1081A0	VALVOLA NON RITORNO BARBED D6	2	PZ																																																						
VL1128A0	VALVOLA VNR BARBED D6	1	PZ																																																						
VM2172A0	CLIP BLOCCAGGIO POMPA CON CIRCUITO	1	PZ																																																						

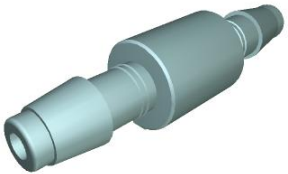
COMPONENTE			RICAMBIO																																																																														
Codice	Descrizione	Immagine	Codice	Descrizione	Lista componenti																																																																												
VL1019A	POMPA VIBRAZIONE		KVL0001A	KIT IMPIANTO LAVAGGIO LM TOP	<table border="1"> <thead> <tr> <th>Codice</th> <th>Descrizione</th> <th>Qtà</th> <th>UM</th> </tr> </thead> <tbody> <tr> <td>0H1226A0</td> <td>LAMIERA CIRCUITO LAVAGGIO LINEMISS</td> <td>1</td> <td>PZ</td> </tr> <tr> <td>0H1226B0</td> <td>LAMIERA CIRCUITO LAVAGGIO LINEMISS</td> <td>1</td> <td>PZ</td> </tr> <tr> <td>EL1180A0</td> <td>RACCORDO NON RITORNO Ø8 Ø8 FEMMIN</td> <td>1</td> <td>PZ</td> </tr> <tr> <td>GN1312A0</td> <td>PASSACAVO GOMMA DE=26 DI=15 SP=10</td> <td>1</td> <td>PZ</td> </tr> <tr> <td>GN1526A0</td> <td>O-RING D.INT6.9 SP1.8</td> <td>1</td> <td>PZ</td> </tr> <tr> <td>RC1008A0</td> <td>FASCETTA ELASTICA D9 ZINCATA</td> <td>3</td> <td>PZ</td> </tr> <tr> <td>RC1019A0</td> <td>FASCETTA ELASTICA D10 ZINCATA</td> <td>3</td> <td>PZ</td> </tr> <tr> <td>RC1242A0</td> <td>TERMINALE CHIUSO D10</td> <td>2</td> <td>PZ</td> </tr> <tr> <td>RC1381A0</td> <td>BIFILARI STRINGI TUBO D10.7 ZINCAT</td> <td>3</td> <td>PZ</td> </tr> <tr> <td>RC1408A0</td> <td>FASCETTA BIFILARE A MOLLA D10.8 TUBO ZN</td> <td>2</td> <td>PZ</td> </tr> <tr> <td>TB2343A0</td> <td>TUBO PVC TRASPARENT E 9X6</td> <td>2.630</td> <td>M</td> </tr> <tr> <td>TB2820A0</td> <td>TUBO EPDM 6X10</td> <td>0.990</td> <td>M</td> </tr> <tr> <td>VH1220A1</td> <td>VITE AUTOFILETTA NTE 4.2X11 TCS+ MARUTE</td> <td>1</td> <td>PZ</td> </tr> <tr> <td>VL1019A0</td> <td>POMPA VIBRAZIONE</td> <td>1</td> <td>PZ</td> </tr> <tr> <td>VL1041C0</td> <td>TAPPO DETERGENTE FORATO Ø12</td> <td>1</td> <td>PZ</td> </tr> <tr> <td>VL1047A1</td> <td>PORTAGOMM A D6 CODOLO D8</td> <td>1</td> <td>PZ</td> </tr> <tr> <td>VL1053A1</td> <td>CIRCUITO LAVAGGIO POMPA USCIT</td> <td>1</td> <td>PZ</td> </tr> <tr> <td>VL1053B0</td> <td>DISTRIBUTOR E USCITA LAVAGGIO ON</td> <td>1</td> <td>PZ</td> </tr> </tbody> </table>	Codice	Descrizione	Qtà	UM	0H1226A0	LAMIERA CIRCUITO LAVAGGIO LINEMISS	1	PZ	0H1226B0	LAMIERA CIRCUITO LAVAGGIO LINEMISS	1	PZ	EL1180A0	RACCORDO NON RITORNO Ø8 Ø8 FEMMIN	1	PZ	GN1312A0	PASSACAVO GOMMA DE=26 DI=15 SP=10	1	PZ	GN1526A0	O-RING D.INT6.9 SP1.8	1	PZ	RC1008A0	FASCETTA ELASTICA D9 ZINCATA	3	PZ	RC1019A0	FASCETTA ELASTICA D10 ZINCATA	3	PZ	RC1242A0	TERMINALE CHIUSO D10	2	PZ	RC1381A0	BIFILARI STRINGI TUBO D10.7 ZINCAT	3	PZ	RC1408A0	FASCETTA BIFILARE A MOLLA D10.8 TUBO ZN	2	PZ	TB2343A0	TUBO PVC TRASPARENT E 9X6	2.630	M	TB2820A0	TUBO EPDM 6X10	0.990	M	VH1220A1	VITE AUTOFILETTA NTE 4.2X11 TCS+ MARUTE	1	PZ	VL1019A0	POMPA VIBRAZIONE	1	PZ	VL1041C0	TAPPO DETERGENTE FORATO Ø12	1	PZ	VL1047A1	PORTAGOMM A D6 CODOLO D8	1	PZ	VL1053A1	CIRCUITO LAVAGGIO POMPA USCIT	1	PZ	VL1053B0	DISTRIBUTOR E USCITA LAVAGGIO ON	1	PZ
Codice	Descrizione	Qtà	UM																																																																														
0H1226A0	LAMIERA CIRCUITO LAVAGGIO LINEMISS	1	PZ																																																																														
0H1226B0	LAMIERA CIRCUITO LAVAGGIO LINEMISS	1	PZ																																																																														
EL1180A0	RACCORDO NON RITORNO Ø8 Ø8 FEMMIN	1	PZ																																																																														
GN1312A0	PASSACAVO GOMMA DE=26 DI=15 SP=10	1	PZ																																																																														
GN1526A0	O-RING D.INT6.9 SP1.8	1	PZ																																																																														
RC1008A0	FASCETTA ELASTICA D9 ZINCATA	3	PZ																																																																														
RC1019A0	FASCETTA ELASTICA D10 ZINCATA	3	PZ																																																																														
RC1242A0	TERMINALE CHIUSO D10	2	PZ																																																																														
RC1381A0	BIFILARI STRINGI TUBO D10.7 ZINCAT	3	PZ																																																																														
RC1408A0	FASCETTA BIFILARE A MOLLA D10.8 TUBO ZN	2	PZ																																																																														
TB2343A0	TUBO PVC TRASPARENT E 9X6	2.630	M																																																																														
TB2820A0	TUBO EPDM 6X10	0.990	M																																																																														
VH1220A1	VITE AUTOFILETTA NTE 4.2X11 TCS+ MARUTE	1	PZ																																																																														
VL1019A0	POMPA VIBRAZIONE	1	PZ																																																																														
VL1041C0	TAPPO DETERGENTE FORATO Ø12	1	PZ																																																																														
VL1047A1	PORTAGOMM A D6 CODOLO D8	1	PZ																																																																														
VL1053A1	CIRCUITO LAVAGGIO POMPA USCIT	1	PZ																																																																														
VL1053B0	DISTRIBUTOR E USCITA LAVAGGIO ON	1	PZ																																																																														

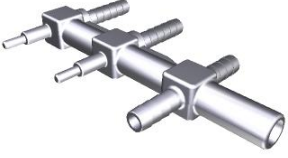
COMPONENTE			RICAMBIO																																										
Codice	Descrizione	Immagine	Codice	Descrizione	Lista componenti																																								
VL1019A	POMPA VIBRAZIONE		KVL0001A	KIT IMPIANTO LAVAGGIO LM TOP	<table border="1"> <thead> <tr> <th>Codice</th> <th>Descrizione</th> <th>Qtà</th> <th>UM</th> </tr> </thead> <tbody> <tr> <td>VL1054A1</td> <td>CIRCUITO LAVAGGIO POMPA INGRESSI</td> <td>1</td> <td>PZ</td> </tr> <tr> <td>VL1054B0</td> <td>DISTRIBUTOR E INGRESSI LAVAGGIO ON</td> <td>1</td> <td>PZ</td> </tr> <tr> <td>VL1061A0</td> <td>FILTRO RETINATO+AF FONDANTE+V NR XFT200</td> <td>1</td> <td>PZ</td> </tr> <tr> <td>VL1081A0</td> <td>VALVOLA NON RITORNO BARBED D6</td> <td>1</td> <td>PZ</td> </tr> <tr> <td>VL1128A0</td> <td>VALVOLA VNR BARBED D6</td> <td>2</td> <td>PZ</td> </tr> <tr> <td>VM1066A0</td> <td>CLIP A SELLA PASSAGGIO CAVI</td> <td>3</td> <td>PZ</td> </tr> <tr> <td>VM1088A0</td> <td>FASCETTA A SCATTO D7.9-D9.2 PP</td> <td>1</td> <td>PZ</td> </tr> <tr> <td>VM1605A0</td> <td>CLIP TWIST LOCK DIAM. 10,2-12,7 MM</td> <td>1</td> <td>PZ</td> </tr> <tr> <td>VM2172A0</td> <td>CLIP BLOCCAGGIO POMPA CON CIRCUITO</td> <td>1</td> <td>PZ</td> </tr> </tbody> </table>	Codice	Descrizione	Qtà	UM	VL1054A1	CIRCUITO LAVAGGIO POMPA INGRESSI	1	PZ	VL1054B0	DISTRIBUTOR E INGRESSI LAVAGGIO ON	1	PZ	VL1061A0	FILTRO RETINATO+AF FONDANTE+V NR XFT200	1	PZ	VL1081A0	VALVOLA NON RITORNO BARBED D6	1	PZ	VL1128A0	VALVOLA VNR BARBED D6	2	PZ	VM1066A0	CLIP A SELLA PASSAGGIO CAVI	3	PZ	VM1088A0	FASCETTA A SCATTO D7.9-D9.2 PP	1	PZ	VM1605A0	CLIP TWIST LOCK DIAM. 10,2-12,7 MM	1	PZ	VM2172A0	CLIP BLOCCAGGIO POMPA CON CIRCUITO	1	PZ
Codice	Descrizione	Qtà	UM																																										
VL1054A1	CIRCUITO LAVAGGIO POMPA INGRESSI	1	PZ																																										
VL1054B0	DISTRIBUTOR E INGRESSI LAVAGGIO ON	1	PZ																																										
VL1061A0	FILTRO RETINATO+AF FONDANTE+V NR XFT200	1	PZ																																										
VL1081A0	VALVOLA NON RITORNO BARBED D6	1	PZ																																										
VL1128A0	VALVOLA VNR BARBED D6	2	PZ																																										
VM1066A0	CLIP A SELLA PASSAGGIO CAVI	3	PZ																																										
VM1088A0	FASCETTA A SCATTO D7.9-D9.2 PP	1	PZ																																										
VM1605A0	CLIP TWIST LOCK DIAM. 10,2-12,7 MM	1	PZ																																										
VM2172A0	CLIP BLOCCAGGIO POMPA CON CIRCUITO	1	PZ																																										
VM2172A	CLIP BLOCCAGGIO POMPA CON CIRCUITO		VM2172A0	CLIP BLOCCAGGIO POMPA CON CIRCUITO																																									
RC1019A	FASCETTA ELASTICA D10 ZINCATA		KRC1019A	KIT 15 PZ. FASCETTA ELASTICA D10 ZINCATA	<table border="1"> <thead> <tr> <th>Codice</th> <th>Descrizione</th> <th>Qtà</th> <th>UM</th> </tr> </thead> <tbody> <tr> <td>RC1019A0</td> <td>FASCETTA ELASTICA D10 ZINCATA</td> <td>15</td> <td>PZ</td> </tr> </tbody> </table>	Codice	Descrizione	Qtà	UM	RC1019A0	FASCETTA ELASTICA D10 ZINCATA	15	PZ																																
Codice	Descrizione	Qtà	UM																																										
RC1019A0	FASCETTA ELASTICA D10 ZINCATA	15	PZ																																										

COMPONENTE			RICAMBIO																			
Codice	Descrizione	Immagine	Codice	Descrizione	Lista componenti																	
VL1081A	VALVOLA NON RITORNO BARBED D		KVL1128A	KIT VALVOLA VNR BARBED D6	<table border="1"> <thead> <tr> <th>Codice</th> <th>Descrizione</th> <th>Qtà</th> <th>UM</th> </tr> </thead> <tbody> <tr> <td>RC1019A0</td> <td>FASCETTA ELASTICA D10 ZINCATA</td> <td>2</td> <td>PZ</td> </tr> <tr> <td>TB2820A0</td> <td>TUBO EPDM 6X10</td> <td>0.080</td> <td>M</td> </tr> <tr> <td>VL1128A0</td> <td>VALVOLA VNR BARBED D6</td> <td>1</td> <td>PZ</td> </tr> </tbody> </table>	Codice	Descrizione	Qtà	UM	RC1019A0	FASCETTA ELASTICA D10 ZINCATA	2	PZ	TB2820A0	TUBO EPDM 6X10	0.080	M	VL1128A0	VALVOLA VNR BARBED D6	1	PZ	
			Codice	Descrizione	Qtà	UM																
			RC1019A0	FASCETTA ELASTICA D10 ZINCATA	2	PZ																
TB2820A0	TUBO EPDM 6X10	0.080	M																			
VL1128A0	VALVOLA VNR BARBED D6	1	PZ																			
KVL1102A	KIT FILTRO IN LINEA DETERGENTE CON VNR	<table border="1"> <thead> <tr> <th>Codice</th> <th>Descrizione</th> <th>Qtà</th> <th>UM</th> </tr> </thead> <tbody> <tr> <td>RC1019A0</td> <td>FASCETTA ELASTICA D10 ZINCATA</td> <td>3</td> <td>PZ</td> </tr> <tr> <td>TB2820A0</td> <td>TUBO EPDM 6X10</td> <td>0.110</td> <td>M</td> </tr> <tr> <td>VL1102A0</td> <td>FILTRO IN LINEA CON VNR BARBED 6 MM</td> <td>1</td> <td>PZ</td> </tr> <tr> <td>VL1102A1</td> <td>FILTRO IN LINEA DET. + VNR BARBED 6 MM</td> <td>1</td> <td>PZ</td> </tr> </tbody> </table>	Codice	Descrizione	Qtà	UM	RC1019A0	FASCETTA ELASTICA D10 ZINCATA	3	PZ	TB2820A0	TUBO EPDM 6X10	0.110	M	VL1102A0	FILTRO IN LINEA CON VNR BARBED 6 MM	1	PZ	VL1102A1	FILTRO IN LINEA DET. + VNR BARBED 6 MM	1	PZ
Codice	Descrizione	Qtà	UM																			
RC1019A0	FASCETTA ELASTICA D10 ZINCATA	3	PZ																			
TB2820A0	TUBO EPDM 6X10	0.110	M																			
VL1102A0	FILTRO IN LINEA CON VNR BARBED 6 MM	1	PZ																			
VL1102A1	FILTRO IN LINEA DET. + VNR BARBED 6 MM	1	PZ																			
KVL1081A	KIT 2 PZ VALVOLA NON RITORNO BARBED D6	<table border="1"> <thead> <tr> <th>Codice</th> <th>Descrizione</th> <th>Qtà</th> <th>UM</th> </tr> </thead> <tbody> <tr> <td>TB2820A0</td> <td>TUBO EPDM 6X10</td> <td>0.240</td> <td>M</td> </tr> <tr> <td>VL1081A0</td> <td>VALVOLA NON RITORNO BARBED D6</td> <td>3</td> <td>PZ</td> </tr> </tbody> </table>	Codice	Descrizione	Qtà	UM	TB2820A0	TUBO EPDM 6X10	0.240	M	VL1081A0	VALVOLA NON RITORNO BARBED D6	3	PZ								
Codice	Descrizione	Qtà	UM																			
TB2820A0	TUBO EPDM 6X10	0.240	M																			
VL1081A0	VALVOLA NON RITORNO BARBED D6	3	PZ																			
RC1242A	TERMINALE CHIUSO D10		KRC1242A	KIT 20 PZ.TERMINALE CHIUSO 110	<table border="1"> <thead> <tr> <th>Codice</th> <th>Descrizione</th> <th>Qtà</th> <th>UM</th> </tr> </thead> <tbody> <tr> <td>RC1242A0</td> <td>TERMINALE CHIUSO D10</td> <td>20</td> <td>PZ</td> </tr> </tbody> </table>	Codice	Descrizione	Qtà	UM	RC1242A0	TERMINALE CHIUSO D10	20	PZ									
Codice	Descrizione	Qtà	UM																			
RC1242A0	TERMINALE CHIUSO D10	20	PZ																			
VL1054B	DISTRIBUTORE INGRESSI LAVAGGIO ONE		KVL1054B	KIT DISTRIBUTORE INGRESSI LAVAGGIO ONE	<table border="1"> <thead> <tr> <th>Codice</th> <th>Descrizione</th> <th>Qtà</th> <th>UM</th> </tr> </thead> <tbody> <tr> <td>VL1054B0</td> <td>DISTRIBUTORE INGRESSI LAVAGGIO ONE</td> <td>1</td> <td>PZ</td> </tr> </tbody> </table>	Codice	Descrizione	Qtà	UM	VL1054B0	DISTRIBUTORE INGRESSI LAVAGGIO ONE	1	PZ									
Codice	Descrizione	Qtà	UM																			
VL1054B0	DISTRIBUTORE INGRESSI LAVAGGIO ONE	1	PZ																			

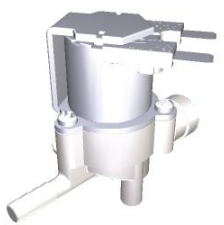
COMPONENTE			RICAMBIO																																																						
Codice	Descrizione	Immagine	Codice	Descrizione	Lista componenti																																																				
VL1053B	DISTRIBUTORE USCITA LAVAGGIO ONE		KVL1072A	KIT POMPA IMPIANTO LAVAGGIO ONE	<table border="1"> <thead> <tr> <th>Codice</th> <th>Descrizione</th> <th>Qtà</th> <th>UM</th> </tr> </thead> <tbody> <tr> <td>GN1526A0</td> <td>O-RING D.INT6.9 SP1.8</td> <td>1</td> <td>PZ</td> </tr> <tr> <td>RC1019A0</td> <td>FASCETTA ELASTICA D10 ZINCATA</td> <td>3</td> <td>PZ</td> </tr> <tr> <td>RC1242A0</td> <td>TERMINALE CHIUSO D10</td> <td>2</td> <td>PZ</td> </tr> <tr> <td>RC1408A0</td> <td>FASCETTA BIFILARE A MOLLA D10.8 TUBO ZN</td> <td>2</td> <td>PZ</td> </tr> <tr> <td>TB2820A0</td> <td>TUBO EPDM 6X10</td> <td>0.120</td> <td>M</td> </tr> <tr> <td>VI1220A1</td> <td>VITE AUTOFILETTA NTE 4.2X11 TCS+ MARUTE</td> <td>1</td> <td>PZ</td> </tr> <tr> <td>VL1019A0</td> <td>POMPA VIBRAZIONE</td> <td>1</td> <td>PZ</td> </tr> <tr> <td>VL1053B0</td> <td>DISTRIBUTORE USCITA LAVAGGIO ON</td> <td>1</td> <td>PZ</td> </tr> <tr> <td>VL1054B0</td> <td>DISTRIBUTORE INGRESSI LAVAGGIO ON</td> <td>1</td> <td>PZ</td> </tr> <tr> <td>VL1081A0</td> <td>VALVOLA NON RITORNO BARBED D6</td> <td>2</td> <td>PZ</td> </tr> <tr> <td>VL1128A0</td> <td>VALVOLA VNR BARBED D6</td> <td>1</td> <td>PZ</td> </tr> <tr> <td>VM2172A0</td> <td>CLIP BLOCCAGGIO POMPA CON CIRCUITO</td> <td>1</td> <td>PZ</td> </tr> </tbody> </table>	Codice	Descrizione	Qtà	UM	GN1526A0	O-RING D.INT6.9 SP1.8	1	PZ	RC1019A0	FASCETTA ELASTICA D10 ZINCATA	3	PZ	RC1242A0	TERMINALE CHIUSO D10	2	PZ	RC1408A0	FASCETTA BIFILARE A MOLLA D10.8 TUBO ZN	2	PZ	TB2820A0	TUBO EPDM 6X10	0.120	M	VI1220A1	VITE AUTOFILETTA NTE 4.2X11 TCS+ MARUTE	1	PZ	VL1019A0	POMPA VIBRAZIONE	1	PZ	VL1053B0	DISTRIBUTORE USCITA LAVAGGIO ON	1	PZ	VL1054B0	DISTRIBUTORE INGRESSI LAVAGGIO ON	1	PZ	VL1081A0	VALVOLA NON RITORNO BARBED D6	2	PZ	VL1128A0	VALVOLA VNR BARBED D6	1	PZ	VM2172A0	CLIP BLOCCAGGIO POMPA CON CIRCUITO	1	PZ
Codice	Descrizione	Qtà	UM																																																						
GN1526A0	O-RING D.INT6.9 SP1.8	1	PZ																																																						
RC1019A0	FASCETTA ELASTICA D10 ZINCATA	3	PZ																																																						
RC1242A0	TERMINALE CHIUSO D10	2	PZ																																																						
RC1408A0	FASCETTA BIFILARE A MOLLA D10.8 TUBO ZN	2	PZ																																																						
TB2820A0	TUBO EPDM 6X10	0.120	M																																																						
VI1220A1	VITE AUTOFILETTA NTE 4.2X11 TCS+ MARUTE	1	PZ																																																						
VL1019A0	POMPA VIBRAZIONE	1	PZ																																																						
VL1053B0	DISTRIBUTORE USCITA LAVAGGIO ON	1	PZ																																																						
VL1054B0	DISTRIBUTORE INGRESSI LAVAGGIO ON	1	PZ																																																						
VL1081A0	VALVOLA NON RITORNO BARBED D6	2	PZ																																																						
VL1128A0	VALVOLA VNR BARBED D6	1	PZ																																																						
VM2172A0	CLIP BLOCCAGGIO POMPA CON CIRCUITO	1	PZ																																																						
RC1408A	FASCETTA BIFILARE A MOLLA D10.8 TUBO ZN		KRC1408A	KIT FASCETTA BIFILARE A MOLLA D10.8 4PZ	<table border="1"> <thead> <tr> <th>Codice</th> <th>Descrizione</th> <th>Qtà</th> <th>UM</th> </tr> </thead> <tbody> <tr> <td>RC1408A0</td> <td>FASCETTA BIFILARE A MOLLA D10.8 TUBO ZN</td> <td>4</td> <td>PZ</td> </tr> </tbody> </table>	Codice	Descrizione	Qtà	UM	RC1408A0	FASCETTA BIFILARE A MOLLA D10.8 TUBO ZN	4	PZ																																												
Codice	Descrizione	Qtà	UM																																																						
RC1408A0	FASCETTA BIFILARE A MOLLA D10.8 TUBO ZN	4	PZ																																																						
EL1436A	EV H2O JG D8-PORTAGOMMA D6 CHECK VALVE		KEL1436A	KIT EV H2O JG D8-PORTAGOMMA D6 VNR	<table border="1"> <thead> <tr> <th>Codice</th> <th>Descrizione</th> <th>Qtà</th> <th>UM</th> </tr> </thead> <tbody> <tr> <td>EL1436A0</td> <td>EV H2O JG D8-PORTAGO MMA D6 CHECK VALVE</td> <td>1</td> <td>PZ</td> </tr> </tbody> </table>	Codice	Descrizione	Qtà	UM	EL1436A0	EV H2O JG D8-PORTAGO MMA D6 CHECK VALVE	1	PZ																																												
Codice	Descrizione	Qtà	UM																																																						
EL1436A0	EV H2O JG D8-PORTAGO MMA D6 CHECK VALVE	1	PZ																																																						

COMPONENTE			RICAMBIO										
Codice	Descrizione	Immagine	Codice	Descrizione	Lista componenti								
TB3009B	TB3132A-TUBO INGRESSO LAVAGGIO ONE		KTB1349A	KIT TB1818A - TUBO 8X4,75 PE BLU L=30	<table border="1"> <thead> <tr> <th>Codice</th> <th>Descrizione</th> <th>Qtà</th> <th>UM</th> </tr> </thead> <tbody> <tr> <td>TB1818A0</td> <td>TUBO 8X4.75 PE BLU</td> <td>30</td> <td>M</td> </tr> </tbody> </table>	Codice	Descrizione	Qtà	UM	TB1818A0	TUBO 8X4.75 PE BLU	30	M
Codice	Descrizione	Qtà	UM										
TB1818A0	TUBO 8X4.75 PE BLU	30	M										
0H7819A	SUPPORTO LAVAGGIO ONE CON ELV STEAM		0H7819A0	SUPPORTO LAVAGGIO ONE CON ELV STEAM									
TB3207A	TUBO D.50 PROLUNGA CAMINO S.C		TB3207A0	TUBO D.50 PROLUNGA CAMINO S.C									
VM2450A	PASSAPARETE 3 TUBI		KVM2450A	KIT PASSAPARETE 3 TUBI	<table border="1"> <thead> <tr> <th>Codice</th> <th>Descrizione</th> <th>Qtà</th> <th>UM</th> </tr> </thead> <tbody> <tr> <td>VM2450A0</td> <td>PASSAPARET E 3 TUBI</td> <td>1</td> <td>PZ</td> </tr> </tbody> </table>	Codice	Descrizione	Qtà	UM	VM2450A0	PASSAPARET E 3 TUBI	1	PZ
Codice	Descrizione	Qtà	UM										
VM2450A0	PASSAPARET E 3 TUBI	1	PZ										